

# **Joint Legacy Viewer (JLV) 2.5.2**

## **User Guide**



**April 2017**

**Version 1.3**

**Department of Veterans Affairs**

**Office of Information and Technology (OI&T)**

## Revision History

Date	Revision	Description	Author
04/13/2017	1.3	Client comments addressed. Document approved	AbleVets
04/12/2017	1.2	Submitted for final review, all comments addressed	AbleVets
03/24/2017	1.1	Comments addressed with client, tentative approval	AbleVets
03/13/2017	1.0	Draft submitted for review	AbleVets
01/15/2017	0.1	Initial draft of artifact	AbleVets

## Artifact Rationale

Per the Veteran-focused Integrated Process (VIP) Guide, the User's Guide is required to be completed prior to Critical Decision Point #2 (CD2), with the expectation that it will be updated as needed. A User Guide is a technical communication document intended to give assistance to people using a particular system, such as VistA end users. It is usually written by a technical writer, although it can also be written by programmers, product or project managers, or other technical staff. Most user guides contain both a written guide and the associated images. In the case of computer applications, it is usual to include screenshots of the human-machine interfaces, and hardware manuals often include clear, simplified diagrams. The language used is matched to the intended audience, with jargon kept to a minimum or explained thoroughly. The User Guide is a mandatory, build-level document, and should be updated to reflect the contents of the most recently deployed build. The sections documented herein are required if applicable to your product.

# Table of Contents

<b>1. Introduction</b>	<b>1</b>
1.1. Purpose	1
1.2. Document Orientation	1
1.2.1. Organization of the Manual	1
1.2.1.1. Intended Audience	2
1.2.2. Assumptions	2
1.2.3. Coordination	2
1.2.4. Disclaimers	2
1.2.4.1. Software Disclaimer	2
1.2.4.2. Documentation Disclaimer	3
1.2.5. Documentation Conventions	3
1.2.6. References and Resources	3
1.3. Enterprise Service Desk and Organizational Contacts	3
<b>2. System Summary</b>	<b>4</b>
2.1. System Configuration	4
2.2. Data Flows	4
2.3. User Access Levels	5
2.4. Continuity of Operations	6
<b>3. Getting Started</b>	<b>6</b>
3.1. Logging On	6
3.1.1. VHA User Log In	7
3.1.2. VBA User Log In	8
3.1.3. Log In Page Messages	9
3.1.3.1. System Status Messages	9
3.1.4. Configuration Options	10
3.1.4.1. User Interface Theme	11
3.1.4.2. Community Data Display	11
3.2. System Menu	11
3.3. Changing User Identification (ID) and Password	13
3.4. Exit System	13
3.5. Caveats and Exceptions	13
<b>4. Using the Software</b>	<b>14</b>
4.1. Default JLV Layout	14
4.1.1. References Widget	14
4.1.2. Patient Portal Data Displays	14
4.1.2.1. Interface Status	15
4.1.2.2. Patient Flags and Alerts	15
4.2. Customizing JLV	17

4.2.1.	Setting the UI Theme.....	17
4.2.2.	Working with the Accessible Theme.....	19
4.2.3.	Keyboard Focus and Screen Navigation .....	20
4.2.3.1.	Keyboard Shortcuts.....	20
4.2.3.2.	Accessible Theme Screen Navigation.....	21
4.2.4.	Creating Custom Tabs .....	23
4.3.	Working with Widgets .....	24
4.3.1.	Opening and Closing Widgets.....	24
4.3.2.	Minimized and Expanded Views.....	25
4.3.3.	Widget Toolbars .....	26
4.3.4.	Refreshing Data in a Widget .....	27
4.3.5.	Widget Navigation and Display Options .....	27
4.3.6.	Date Range Filters.....	29
4.3.6.1.	Quick Date Range Filter .....	29
4.3.6.2.	Start and End Date Filter .....	30
4.3.7.	Context Management .....	31
4.3.7.1.	Unable to Communicate with Vault .....	32
4.3.7.2.	Establishing Context .....	32
4.3.7.3.	Context Synchronization Failure .....	33
4.3.7.4.	Suspending Context .....	33
4.3.8.	User-Restricted Access to Patient Data.....	34
4.3.8.1.	VHA Users Viewing DoD-only Patients .....	34
4.3.8.2.	VBA Users Viewing DoD-only Patients .....	35
4.3.8.3.	Access to DoD Sensitive Records.....	35
4.3.9.	Using Report Builder.....	37
4.3.9.1.	Creating Reports.....	37
4.3.10.	VistA Imaging Viewer .....	40
4.4.	Patient Searches .....	42
4.4.1.	PDWS Search Rules and Supported Searches .....	43
4.4.2.	MVI Search Guidelines.....	43
4.4.3.	Patient Search Using DoD ID.....	43
4.4.4.	Patient Search Using SSN .....	44
4.4.5.	Advanced Patient Search Options .....	45
4.4.6.	Family Member Search .....	46
4.4.7.	Recently Viewed Patients List .....	48
4.5.	Widget Functionality.....	49
4.5.1.	Patient Demographics.....	49
4.5.1.1.	Race Data Terminology Normalization.....	50
4.5.1.2.	Demographics from Community Partners .....	51
4.5.1.3.	Viewing Third-Party Insurance Information .....	51
4.5.2.	Allergies.....	52

4.5.2.1.	Allergies Widget Data .....	53
4.5.2.2.	Viewing Allergy Details .....	54
4.5.2.3.	Terminology Normalization.....	55
4.5.3.	Community Health Summaries and Documents – VA .....	55
4.5.3.1.	Community Health Summaries and Documents – VA Widget Data.....	55
4.5.3.2.	Viewing VA Community Health Summary Documents.....	56
4.5.4.	Documents.....	57
4.5.4.1.	Documents Widget Data.....	58
4.5.4.2.	Viewing Documents.....	59
4.5.4.3.	Viewing DoD Sensitive Data.....	60
4.5.4.4.	Display and Filter Options.....	60
4.5.4.5.	Terminology Normalization.....	60
4.5.5.	Military Health System (MHS) GENESIS .....	61
4.5.5.1.	MHS GENESIS Widget Data .....	61
4.5.5.2.	Viewing MHS GENESIS Documents .....	62
4.5.6.	Outpatient Encounters.....	63
4.5.6.1.	Outpatient Encounters Widget Data.....	63
4.5.6.2.	Viewing Outpatient Encounter Details .....	64
4.5.6.3.	Viewing Outpatient Encounter Notes .....	65
4.5.6.4.	Viewing Sensitive Data in the Outpatient Encounters Widget.....	66
4.5.6.5.	Display and Filter Options.....	66
4.5.6.6.	Terminology Normalization.....	67
5.	Troubleshooting .....	68
5.1.	Special Instructions for Error Correction .....	68
5.1.1.	Log In Page Error Messages .....	68
5.1.2.	VistA Imaging Viewer Integration Error .....	69
5.1.3.	‘Cannot View Patients’ Error .....	70
5.1.4.	System Error Messages.....	70
5.1.5.	VA VLER Server Error Message .....	71
5.1.6.	eHX Error Message .....	71
6.	Acronyms and Abbreviations.....	72

## Table of Figures

Figure 1: JLV Components and Tiers .....	5
Figure 2: Scheduled Downtime and Non-Scheduled Outage Workflows.....	6
Figure 3: Single Sign-On Page for VA Users .....	7
Figure 4: System Status on the JLV Login Page .....	9
Figure 5: Edit Profile Link (JLV Login Page) .....	10
Figure 6: Include Community Data Option (JLV Login Page).....	11
Figure 7: JLV Tools on the Portal Pages .....	12
Figure 8: More JLV Functionality .....	12
Figure 9: System Status Details .....	13
Figure 10: JLV Log Out Icon.....	13
Figure 11: References Widget.....	14
Figure 12: Unavailable Interface Message Banner .....	15
Figure 13: Patient Flags Indicator.....	16
Figure 14: Patient Flags and Postings Window .....	16
Figure 15: Default UI Theme.....	17
Figure 16: Green UI Theme .....	18
Figure 17: Blue UI Theme .....	18
Figure 18: Gray UI Theme.....	19
Figure 19: Accessible UI Theme .....	19
Figure 20: Navigation Using Elements with Keyboard Focus.....	22
Figure 21: IPO3 Tab with Keyboard Focus .....	22
Figure 22: Close Button with Keyboard Focus.....	23
Figure 23: Add New Tab .....	23
Figure 24: Widgets on the Patient Portal .....	24
Figure 25: Widget Tray on the Patient Portal .....	25
Figure 26: Minimized Widgets with Date Range Filter Applied .....	26
Figure 27: Widget Navigation Tools .....	29
Figure 28: Quick Date Range Filter Options .....	30
Figure 29: Start and End Date Display Filter.....	31
Figure 30: Context Indicator on the JLV Portal Pages .....	32
Figure 31: CCOW Error Message.....	32
Figure 32: CCOW Warning Message .....	33
Figure 33: Context Synchronization Failure.....	33
Figure 34: Suspending Context.....	34
Figure 35: VA User Restricted Access Dialog .....	34
Figure 36: VBA User Audit Notification.....	35
Figure 37: Restricted Access Notification .....	35
Figure 38: DoD Sensitive Record and Audit Dialog .....	36
Figure 39: Report Builder Icon on the Portal Toolbar .....	37
Figure 40: Report Builder Window & Add Record to Report Option.....	38
Figure 41: Report Builder Tools .....	39
Figure 42: Preview of Record in Report Builder Window.....	40
Figure 43: Camera Icon in the Image Column.....	41
Figure 44: Thumbnail and Link in Details View .....	42
Figure 45: Patient Search Using DoD ID.....	44
Figure 46: Patient Search Using Patient's SSN .....	45
Figure 47: Advanced Patient Search Options .....	46
Figure 48: Patient Search Using Sponsor SSN .....	47

Figure 49: Family Members Dialog.....	48
Figure 50: Recently Viewed Patients List.....	49
Figure 51: Patient Demographics on the Patient Portal .....	50
Figure 52: Standardized Race Data in the Demographics Widget.....	50
Figure 53: Insurance Information .....	52
Figure 54: Allergies Widget.....	53
Figure 55: Allergies Widget, Minimized View .....	54
Figure 56: Allergy Details View .....	54
Figure 57: Terminology Normalization – Allergies Widget.....	55
Figure 58: Community Health Summaries and Documents – VA, Minimized View.....	56
Figure 59: Community Health Document.....	57
Figure 60: Documents Widget, Minimized View .....	58
Figure 61: Documents Widget, Expanded View .....	59
Figure 62: Details of a Document Record .....	59
Figure 63: Terminology Normalization – Documents Widget .....	61
Figure 64: MHS GENESIS Widget, Minimized View .....	62
Figure 65: CCDa Document Display .....	63
Figure 66: Outpatient Encounters Widget, Expanded View .....	64
Figure 67: Outpatient Encounters, Details View .....	65
Figure 68: Outpatient Encounters, Encounter Note Link.....	65
Figure 69: Outpatient Encounters Widget, Sensitive Record .....	66
Figure 70: Terminology Normalization – Outpatient Encounters .....	67
Figure 71: eHX Error Message .....	71

## Table of Tables

Table 1: Major Sections and Descriptions .....	1
Table 2: Reference Documents .....	3
Table 3: ESD Contact Information .....	4
Table 4: JLV User Profiles .....	5
Table 5: Accessible Theme Keyboard Shortcuts .....	20
Table 6: Widget Toolbar Icons .....	26
Table 7: Navigation Icons and Actions.....	28
Table 8: Error Messages and Resolution Steps.....	68
Table 9: System Error Messages.....	70
Table 10: Community Health Summaries and Documents – VA Widget Error Message .....	71
Table 11: Acronyms and Abbreviations .....	72



# 1. Introduction

JLV is a centrally hosted, java-based web application that is managed as a single code baseline, and deployed in separate Department of Defense (DoD) and Department of Veteran Affairs (VA) environments. JLV is a browser-based, graphical user interface (GUI) that provides an integrated, read-only view of Electronic Health Record (EHR) data from the DoD, VA, and Virtual Lifetime Electronic Record (VLER) eHealth Exchange (eHX) partners, within a single application.

The JLV GUI retrieves and displays clinical data from a number of native data sources and systems. The data is then presented to the user in a simple to use, web-based interface, through widgets. Each widget corresponds to a clinical data domain. JLV eliminates the need for VA and DoD clinicians to access separate, disparate viewers. Born from a joint DoD-VA venture called JANUS, JLV was directed by the Secretary of Defense and Secretary of Veterans Affairs in early 2013 to further support interoperability between the two departments.

JLV users can create and personalize tabs, drag and drop widgets onto tabs, sort data within a widget's columns, set date filters, and expand a widget for a detailed view of patient information. Within each widget, a circular, blue icon indicates the data retrieved is from a VA source; a square orange icon indicates that the data retrieved is from a DoD source; and a hexagonal, purple icon indicates data that the data retrieved is from VA VLER partners.

## 1.1. Purpose

The purpose of the User Guide is to familiarize VA users with the important features and navigational elements of the JLV GUI.

## 1.2. Document Orientation

### 1.2.1. Organization of the Manual

[Table 1](#) briefly describes the major sections of the JLV User Guide.

**Table 1: Major Sections and Descriptions**

Major Section Name	Description
System Summary	Provides a general description of the system, and the purpose for which it is intended.
Getting Started	Describes VA user log on to the JLV User Interface (UI), JLV user profile information and configuration settings, UI theme settings, and exiting JLV.

Major Section Name	Description
Using the Software	Details functionality, and provides example figures of the JLV UI, such as: <ul style="list-style-type: none"> <li>• Accessing Patient Data</li> <li>• Using Widgets</li> <li>• Context Management</li> <li>• User Restricted Access (break-the-glass)</li> <li>• Using the Report Builder</li> <li>• Working with the Accessible Interface</li> <li>• Patient Portal Data Domains</li> </ul>
Troubleshooting	Provides error message examples, troubleshooting information, and suggested resolution steps for JLV users.

### 1.2.1.1. Intended Audience

This document is intended for the VA JLV users supporting the:

- Veterans Health Administration (VHA)
- Veterans Benefits Administration (VBA)

Please refer to [Section 2.3, User Access Levels](#), for more information regarding user types and access.

### 1.2.2. Assumptions

This guide was written assuming that the intended audience has authorization to access JLV, possesses the appropriate VA credentials necessary to log in to JLV, and will utilize the functionality of JLV to support VHA and/or VBA workflows.

### 1.2.3. Coordination

JLV is a read only view of EHR, coordinated with the DoD. Its purpose is to provide health care and benefits professionals an integrated view of participating government sources of Veteran and active duty military health information.

JLV is a centralized enterprise application, and does not require deployments to any local facilities. Deployment of JLV occurs at the Austin Information Technology Center (AITC) and Philadelphia Information Technology Center (PITC), and requires no site preparation for deployment.

Post-deployment hardware, software, and system support roles and responsibilities are defined in the *JLV Production Operations Manual (POM)*, and the *JLV System Design Document (SDD)*.

### 1.2.4. Disclaimers

#### 1.2.4.1. Software Disclaimer

This software was developed at the VA by employees of the Federal Government in the course of their official duties. Pursuant to Title 17, Section 105 of the United States Code, this software

is not subject to copyright protection, and is in the public domain. VA assumes no responsibility whatsoever for its use by other parties, and makes no guarantees, expressed or implied, about its quality, reliability, or any other characteristic. We would appreciate acknowledgement if the software is used. This software can be redistributed and/or modified freely, if any derivative works bear some notice that they are derived from it, and any modified versions bear some notice that they have been modified.

#### 1.2.4.2. Documentation Disclaimer

The appearance of external hyperlink references in this manual does not constitute endorsement by the VA of the linked website(s), or the information, products, or services contained therein. The VA does not exercise any editorial control over the information you may find at these locations. All links are provided with the intent of meeting the mission of VA web sites.

#### 1.2.5. Documentation Conventions

This document is designed for both online and hardcopy consumption.

- [Cross References](#) are indicated by blue, underlined text, and provide a hyperlink to figures, tables, and other sections within this guide
- The conventions used in this document for emphasis are bold and italicized text
- The information symbol  is used to inform the reader of additional, general information

#### 1.2.6. References and Resources

The documents used as references to prepare this User Guide are listed in [Table 2](#). Once approved, all documents referenced throughout this User Guide are available on the [Technical Services Project Repository](#) (TSPR)<sup>1</sup>.

Table 2: Reference Documents

Document Name	Document Link	Date
JLV 2.5.2 SDD	<a href="#">CLIN 0003AA JLV 2.5.2 System Design Document</a>	March, 2017
JLV 2.5.1 SDD	<a href="#">CLIN 0003AA JLV 2.5.1 System Design Document</a>	November 2016

### 1.3. Enterprise Service Desk and Organizational Contacts

Prior to contacting the Enterprise Service Desk (ESD) for support ([Table 3](#)), please refer to [Section 3, Getting Started](#), for detailed information about how to access JLV, and to [Section 5, Troubleshooting](#), for suggested resolution steps and troubleshooting information.

---

<sup>1</sup> **NOTE:** Access to TSPR is restricted, and must be requested.

If you are an authorized user, are having trouble logging in to JLV, or are experiencing other application issues, please use contact the ESD via the telephone number unique to your agency for assistance.

**NOTE:** Unregistered users should contact support to request access to JLV.

**Table 3: ESD Contact Information**



**VA Enterprise Service Desk**  
Phone: 888-596-4357  
E-mail: [NSDTuscaloosaUSD@va.gov](mailto:NSDTuscaloosaUSD@va.gov)

## 2. System Summary

JLV is a patient-centric presentation system that pulls information from disparate health care systems in real time, for viewing in a web browser. The web application provides the ability to view specific clinical data within patients' longitudinal health records, stored in EHR systems available to the VA and the DoD.

JLV is optimized for use with the VA standard browser, Internet Explorer (IE), currently version 11. It is required that JLV is accessed through IE versions 9 and above. Other web browsers may function, but are not certified for support. It is also recommended that the Adobe Reader should be installed on the user's system.

The major JLV GUI functions include:

- Access to patient data
- Use of widgets
- Context management
- User-restricted access (Break the Glass)
- Use of the Report Builder feature
- Option to use the accessible interface
- Patient Portal data domains

### 2.1. System Configuration

JLV is a read only web application with no clinical data input or output to other EHR applications within VA or DoD.

Refer to the *JLV 2.5.2 Deployment, Installation, Backout, and Rollback Guide (DIBR)* for a complete overview of JLV components, and the production environments in which the components reside. Once approved, all referenced documentation for JLV 2.5.2 will be available on the TSPR.

### 2.2. Data Flows

[Figure 1](#) depicts the data flows in the JLV system. All patient data flows are read only from their corresponding sources.

Figure 1: JLV Components and Tiers

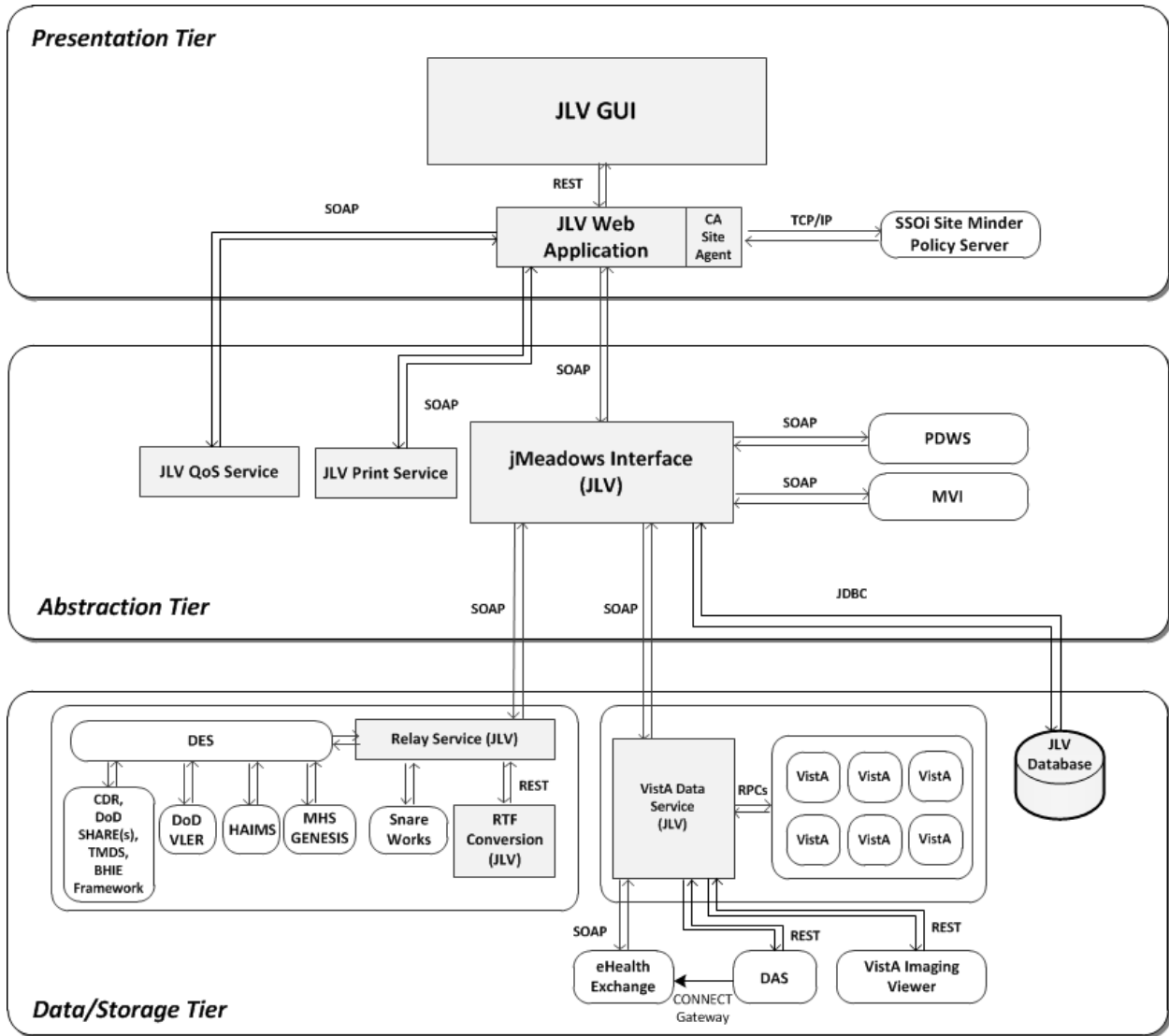

### 2.3. User Access Levels

Table 4 describes the authorized JLV users and their responsibilities.

Table 4: JLV User Profiles

User	Description and Responsibilities
DoD Clinician	DoD clinicians access the patient EHRs.
VHA	VA clinicians and administrative staff who access the patient EHRs to assist in providing health care services.
VBA	VA administrative staff who access patient EHRs to assist in Veterans benefits administration processes.

Please refer to [Section 3.1, Logging On](#), for a description of the VA users and their access to JLV data. Also, refer to [Section 4.3.8, User Restricted Access to Patient Data](#), for a description of VHA and VBA user access levels to DoD-only patient data and/or DoD sensitive patient data.

## 2.4. Continuity of Operations

The operation of JLV components hosted in VA environments is administered as a service by the VA AITC and PITC data centers. These organizations maintain Continuity of Operations (COOP) team linkage and documentation.

Refer to the *JLV 2.5.2 POM* for specific information about possible service interruptions, system errors, support operations, and scheduled maintenance.

[Figure 2](#) depicts the workflows for scheduled downtime and non-scheduled outages.

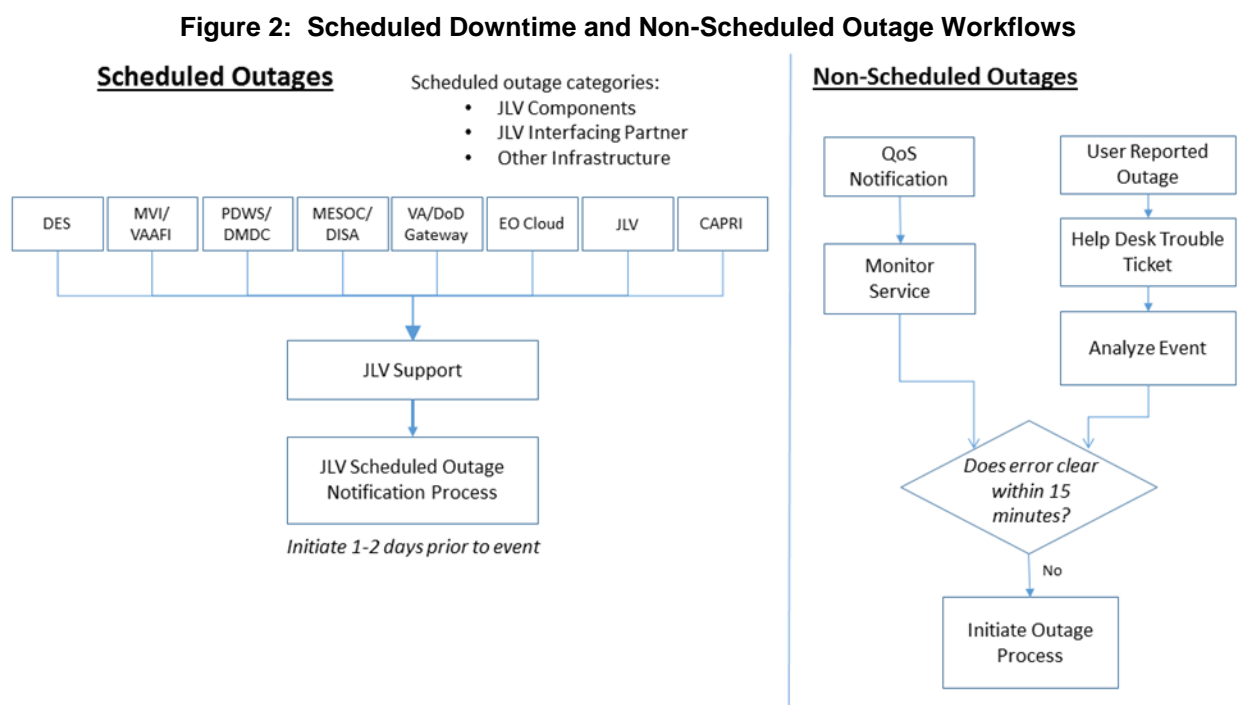

## 3. Getting Started

The subsections below provide information for logging in to JLV, setting options via the JLV Login page, and the display of system status messages.

### 3.1. Logging On

Authorized, registered users within the VA and DoD are provided access information to log in to JLV. VHA users who have access to the Computerized Patient Record System (CPRS) are automatically authorized to use JLV. VBA users must contact the ESD for access.

Refer to [Section 5, Troubleshooting](#), for more tips on logging in to JLV.



Users who are not authorized to access JLV will see an *Access denied* message. If you believe you have received the message in error, please contact the VA ESD

During future log in attempts, the last successful and unsuccessful log in attempts are displayed in the lower left corner of the JLV log in page, along with the date, local time, and the Internet Protocol (IP) address from which access was made, or attempted access failed.

### 3.1.1. VHA User Log In

The log in steps detailed below apply to VHA users accessing JLV through a Uniform Resource Locator (URL).

To log in to JLV:

1. Enter the VHA's URL for the JLV web application into the address bar of your Internet browser. (<https://jlv.med.va.gov/JLV>)
2. All VA users will be redirected to the **VA Single Sign-On** page ([Figure 3](#)). VA users must sign in to, and be authenticated by, the Single Sign-On system in order to access JLV.



Users with a Personal Identity Verification (PIV) exemption may select any of the alternate authentication options available through the VA Single Sign-On log in page for access to JLV. PIV exemptions, if required, can be obtained from the ESD.

**Figure 3: Single Sign-On Page for VA Users**

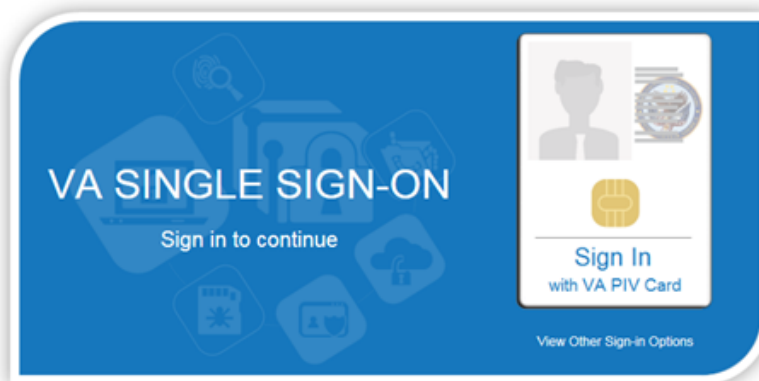

**WARNING:** You have accessed a United States Government computer. Unauthorized use of this computer is a violation of federal law and may be subject you to civil and criminal penalties. This computer and automated systems which run on it, are monitored. Individuals are not guaranteed privacy while using government computers and should, therefore, not expect it. Communications made using this system may be disclosed as allowed by federal law.

[Department of Veterans Affairs | Privacy Policy](#)

3. Once authenticated by the Single Sign-On system, you are redirected to JLV
4. Read the important user consent information regarding access to a Government information system, and click **I Accept**
5. If desired, check the **Accessibility Mode** option in the top right corner, above the JLV log in page fields. If selected, JLV opens and displays the application in the Accessible UI theme. See [Section 4.2.2, Working with the Accessible Theme](#), for detailed information
6. Enter your VA log in credentials:
  - a. Enter your CPRS Veterans Health Information Systems and Technology Architecture (VistA) Access Code
  - b. Enter your CPRS (VistA) Verify Code
  - c. Select VA from the **Agency** field
  - d. From the Site field, Select your VA Medical Center or regional Health Care System from the Site field
7. Click **Login**

### 3.1.2. VBA User Log In

The following instructions apply to VBA users accessing JLV through a URL only.

To log in to JLV:

1. Enter the VBA's URL for the JLV web application into the address bar of your Internet browser. ([https://jlv.med.va.gov/JLV\\_Claims](https://jlv.med.va.gov/JLV_Claims))
2. All VA users will be redirected to the **VA Single Sign-On** page ([Figure 3](#)). VA users must sign in to, and be authenticated by, the Single Sign-On system in order to access JLV



Users may select any of the authentication options available through the VA Single Sign-On log in page for access to JLV.

3. Once authenticated by the Single Sign-On system, you are redirected to JLV
4. Read the important user consent information regarding access to a Government information system and click **I Accept**
5. If desired, check the **Accessibility Mode** option in the top right corner, above the JLV log in page fields. If selected, JLV opens and displays the application in the Accessible UI theme. See [Section 4.2.2, Working with the Accessible Theme](#), for detailed information
6. Enter your log in credentials:
  - a. Enter your Compensation and Pension Record Interchange (CAPRI) Access Code
  - b. Enter your CAPRI Verify Code
7. Click **Login**



### 3.1.3. Log In Page Messages



#### 3.1.3.1. System Status Messages

System status updates are received from JLV's Quality of Service (QoS) Monitor, also called the Health Monitor. QoS monitors the status of services that JLV uses to connect to DoD and VA data sources, which include: Master Veteran Index (MVI), Patient Discovery Web Service (PDWS), Relay Service, VistA Data Service (VDS), and jMeadows Data Service.

JLV displays the system status on the **Log in** page, below the user credential fields ([Figure 4](#)), and at the top of the Portal Pages ([Figure 9](#)).

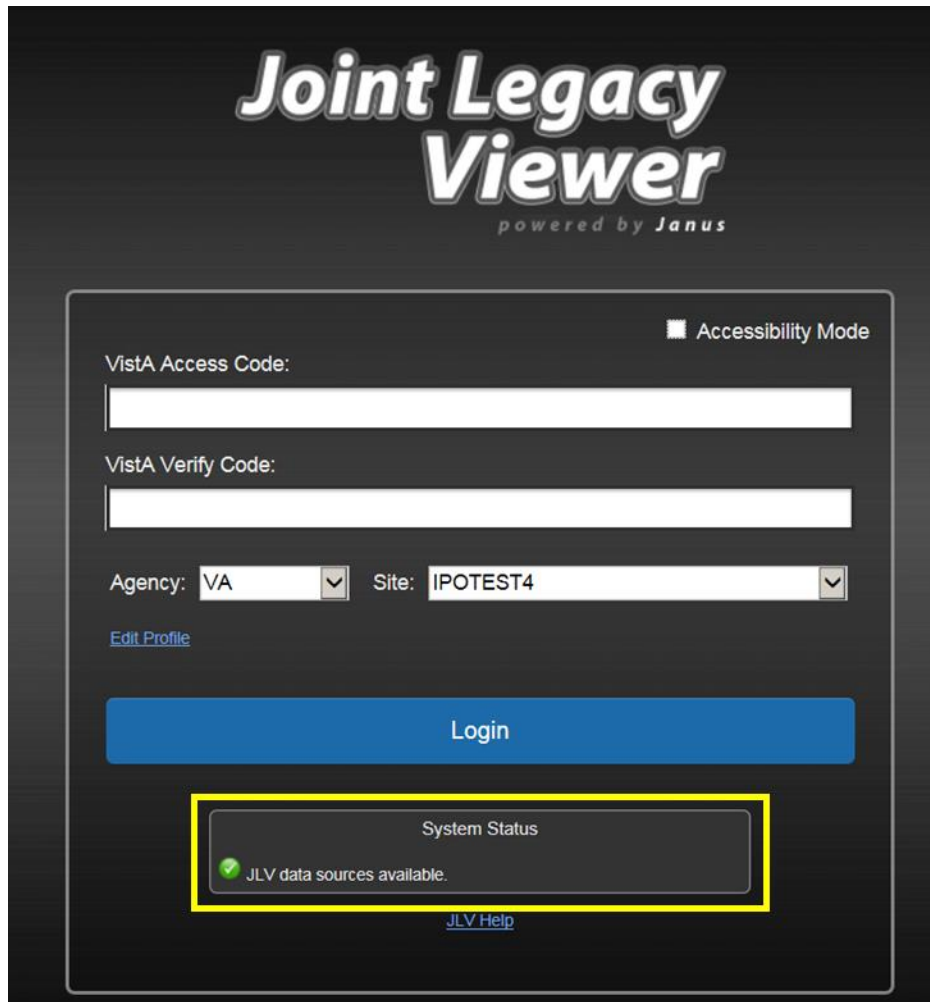
Figure 4: System Status on the JLV Login Page



- When all monitored systems and services are online and connected, a green icon  appears next to the status message *JLV data sources are available*.
- When one or more monitored systems or services are offline or unavailable, a yellow warning icon  appears next to the status message *JLV is having problems*. Notification of unavailable systems persisting longer than ten (10) minutes should be reported to the

VA Enterprise Service Desk ([Section 1.3, Enterprise Service Desk and Organizational Contacts](#)).

- When the jMeadows Data Service is unavailable, a red icon  appears next to the message, *JLV is having problems. jMeadows Data Service is unavailable. JLV may not function properly.* Users may not be able to log in to JLV, or view patient data, until the jMeadows connection is restored.

### 3.1.4. Configuration Options

One method of setting configuration options is by using the **Edit Profile** link ([Figure 5](#)) to access the user profile fields through the JLV **Login** page.

The subsections below detail the processes for enabling/disabling the option to **Include Community Data**, and setting the UI theme via the **Edit Profile** link.

-  Options selected here are saved to the user profile by clicking **Save and Login**, and remain set for all subsequent JLV sessions, until changed by the user.

Figure 5: Edit Profile Link (JLV Login Page)



The screenshot displays the JLV Login Page interface. At the top, the logo reads "Joint Legacy Viewer" with "powered by Janus" underneath. The main form area includes an "Accessibility Mode" toggle, a "VistA Access Code" input field, a "VistA Verify Code" input field, and two dropdown menus for "Agency" (set to "VA") and "Site" (set to "IPOTEST4"). A blue "Login" button is positioned below these fields. A link labeled "Edit Profile" is highlighted with a yellow rectangular box. At the bottom of the form, there is a "System Status" section showing a green checkmark and the text "JLV data sources available.", along with a "JLV Help" link.

### 3.1.4.1. User Interface Theme

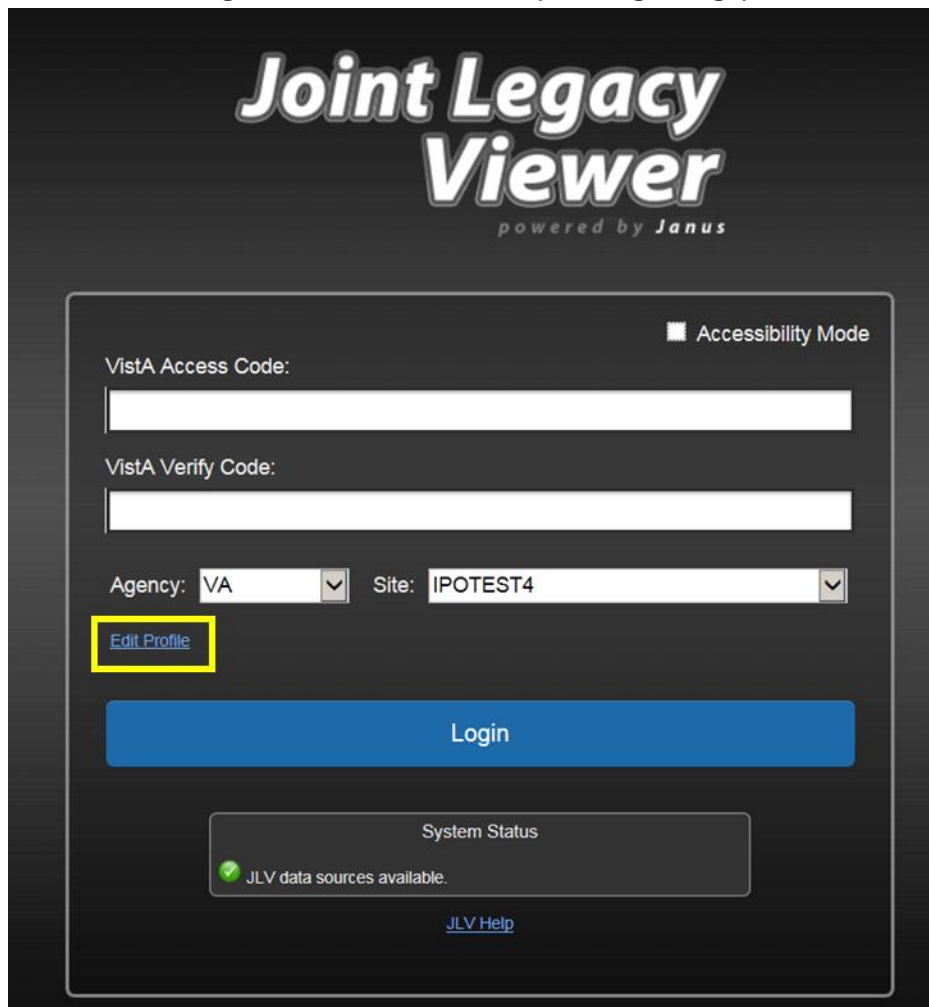
Selecting a UI theme sets the font color and foreground/background colors of the JLV GUI, including the widgets, toolbars, and dialog boxes. Theme color selections are Default, Green, Blue, Gray, and Accessible. The UI theme choices appear above the community data option, as seen in [Figure 6](#).



The **Accessible** theme provides larger fonts, enhanced tab and keystroke functionality, and screen reader compatibility, compliant with Federal accessibility requirements and Section 508 standards. Refer to [Section 4.2.2, Working with the Accessible Theme](#), for more information.

### 3.1.4.2. Community Data Display

Checking (enabling) the **Include Community Data** option tells JLV to query for, receive, and integrate patient data from external VA VLER community partner data sources. The community data setting is in the bottom half of the Edit Profile dialog, seen in [Figure 6](#).





VBA users do not have access to community data, and will not see the **Include Community Data** feature.

**Figure 6: Include Community Data Option (JLV Login Page)**

The screenshot shows a dark-themed dialog box for the JLV Login Page. At the top right, there is a checkbox labeled "Accessibility Mode". Below this are two text input fields: "VistA Access Code:" and "VistA Verify Code:". Underneath these are two dropdown menus: "Agency:" with "VA" selected and "Site:" with "IPOTEST4" selected. The "User Interface Theme" section contains five radio buttons: "Default", "Green", "Blue" (which is selected), "Gray", and "Accessible". Below the themes is the "Community Data Display" section, which has a single checkbox that is currently unchecked. At the bottom right, there are two buttons: "Save and Login" (highlighted in blue) and "Cancel". At the very bottom center, there is a small blue link labeled "JLV Help".

## 3.2. System Menu

After a successful log in your user name is shown in the upper right corner of the application, and the JLV portal pages are displayed. The JLV portal pages are:

- The Patient Portal 
- The Provider Portal 

Each portal page has a toolbar (highlighted in [Figure 7](#)) that enables quick access to the following features:





- **Configuration Options:** Click the **cog wheel** icon  in the top right corner of either portal page to set user preferences, including the UI theme. Refer to [Section 4.2, Customizing JLV](#).
- **Report Builder:** Click the **Report Builder** icon  in the top right corner of either portal page to create custom reports. Refer to [Section 4.3.9, Using Report Builder](#).
- **Access Online Help:** Click the **Help** icon  in the top right corner of either portal page to open online help.
- **Log Out of JLV:** Click the **Log Out** icon  to log out and close the current JLV session. Refer to [Section 3.4, Exit the System](#).

Figure 7: JLV Tools on the Portal Pages



The following functions can also be performed from the portal pages (highlighted in [Figure 8](#)):



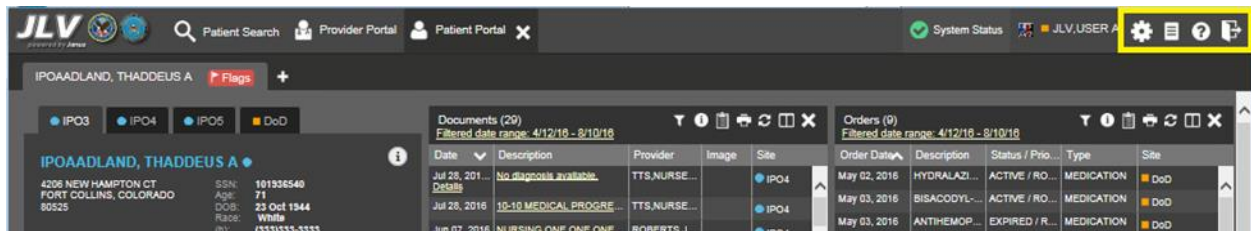





- Perform a Patient Search 
- Switch between the Patient Portal  and the Provider Portal 
- View the system status    (Hover over **System Status**)
- View Context Management status  
- Open the widget tray **Open Widget Tray**  (bottom of the portal pages)

Figure 8: More JLV Functionality



The system status is displayed to the left of the user name. Hovering over **System Status** will provide additional information, as seen in [Figure 9](#).

**Figure 9: System Status Details**

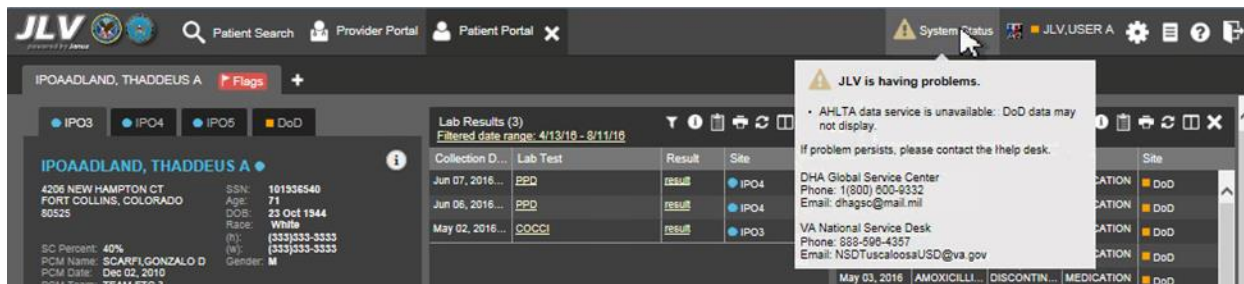

### 3.3. Changing User Identification (ID) and Password

No functionality is available for changing a user ID and password in JLV.

For information about log in errors, access code errors, or verify code errors, see [Section 5, Troubleshooting](#).

### 3.4. Exit System

To end the current session and exit JLV, click the **Log Out** icon  (highlighted in [Figure 10](#)) at any time.

**Figure 10: JLV Log Out Icon**

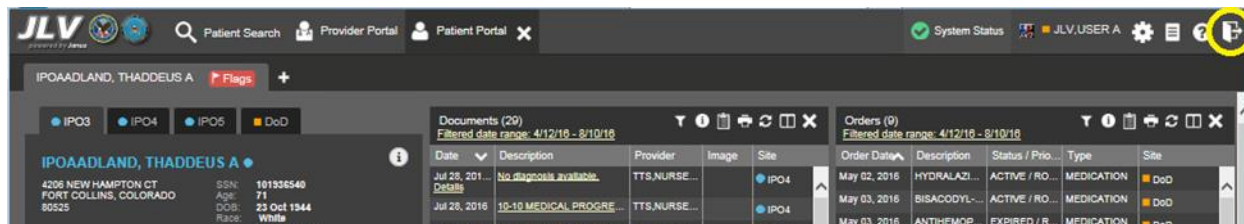

A JLV session will end automatically after five minutes of inactivity. Automatic termination of a session does not clear the last screen in use and display the Login page, but connectivity to, and the functionality of, JLV is terminated. To re-open a JLV session, log in to JLV again.

### 3.5. Caveats and Exceptions

JLV audits user access to restricted patient records when VHA or VBA users view DoD-only patients. JLV also blocks access to designated patient records by particular users. See [Section 4.3.8, User-Restricted Access to Patient Data](#), for detailed information.

## 4. Using the Software

### 4.1. Default JLV Layout

New JLV users will see a pre-configured, default widget layout on the Patient Portal  when JLV opens. The default layout includes the **Allergies, Problem List, Documents, Outpatient Medications, and Lab Results** widgets.

In this release, only the **References** widget is available to JLV users on the Provider Portal .

#### 4.1.1. References Widget

The References is shown by default on the Provider Portal . The References widget displays hyperlinked references for providers to online clinical medicine resources. Click a reference link to access the associated website. To add a new reference link, click **Add**.

Delete a reference by right-clicking the link and selecting **Delete URL**. Users will not be able to delete references included in the default widget configuration.

Figure 11: References Widget



#### 4.1.2. Patient Portal Data Displays

The Patient Portal displays a selected patient's clinical records and other patient-centric information.



Users can configure the layout of widgets on the Patient Portal and create multiple widget tabs, as described in [Section 4.2, Customizing JLV](#), and in [Section 4.3.1, Opening and Closing Widgets](#). Customizations are saved to the User Profile as set, and remain until manually changed.

#### 4.1.2.1. Interface Status

Interface status updates are available for each clinical domain (widget) except **Clinical Reminders**, and can be accessed through a widget's toolbar. An icon on the toolbar provides a status indicator for DoD, VA, and community partner data sources. There are two status conditions: all sources are connected (available), or one or more sources are not connected (unavailable). Clicking either icon opens the interface status for DoD, VA, and community partner sources in a standalone window. For the status of DoD sources, the entries are derived from responses received from Data Exchange Services (DES). Interface status notifications accessed from the widget show connection status at the domain level.



Interface status updates for clinical domains are not the same as system status messages displayed in the top right corner of the portal. See [Section 3.1.3.1, System Status Messages](#).

[Figure 12](#) shows the status message banner displayed in a widget. The banner can be closed by clicking the **X** to the right of the status message. This action hides the banner during the current JLV session until the widget is closed. Re-opening the widget at a later time will restore the banner display if the problem persists.

**Figure 12: Unavailable Interface Message Banner**

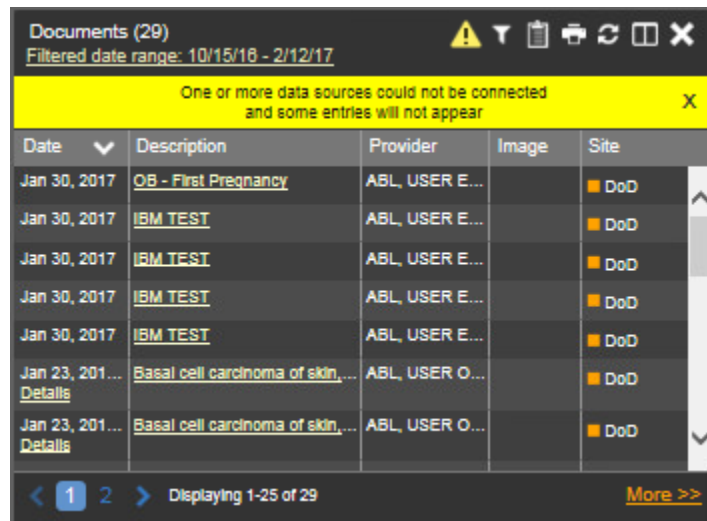

#### 4.1.2.2. Patient Flags and Alerts

If the patient has one or more clinical warnings, alerts, or flags in their record from VA and DoD sites, a Flag icon will display next to the Patient Name tab, above the Demographics widget, on the Patient Portal ([Figure 13](#)).

Figure 13: Patient Flags Indicator

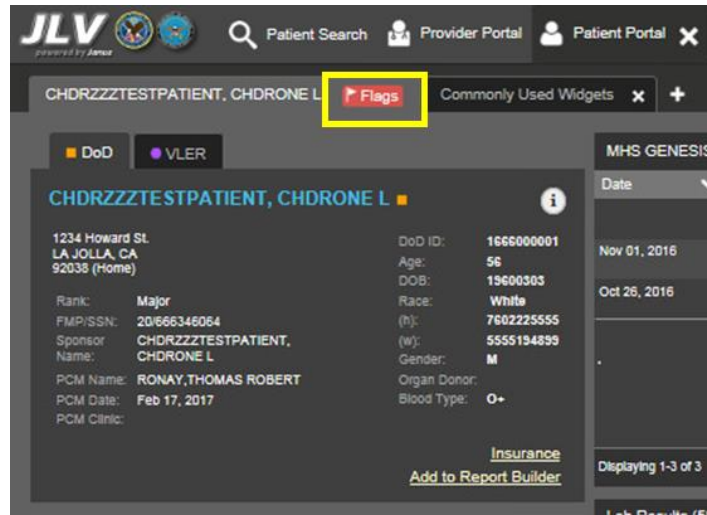

Click **Flags** to open the **Patient Flags and Postings** window (Figure 14). The window displays a list of alerts and flags within the patient’s record. If the patient’s record does not contain any clinical warnings, the button is not displayed.

Figure 14: Patient Flags and Postings Window

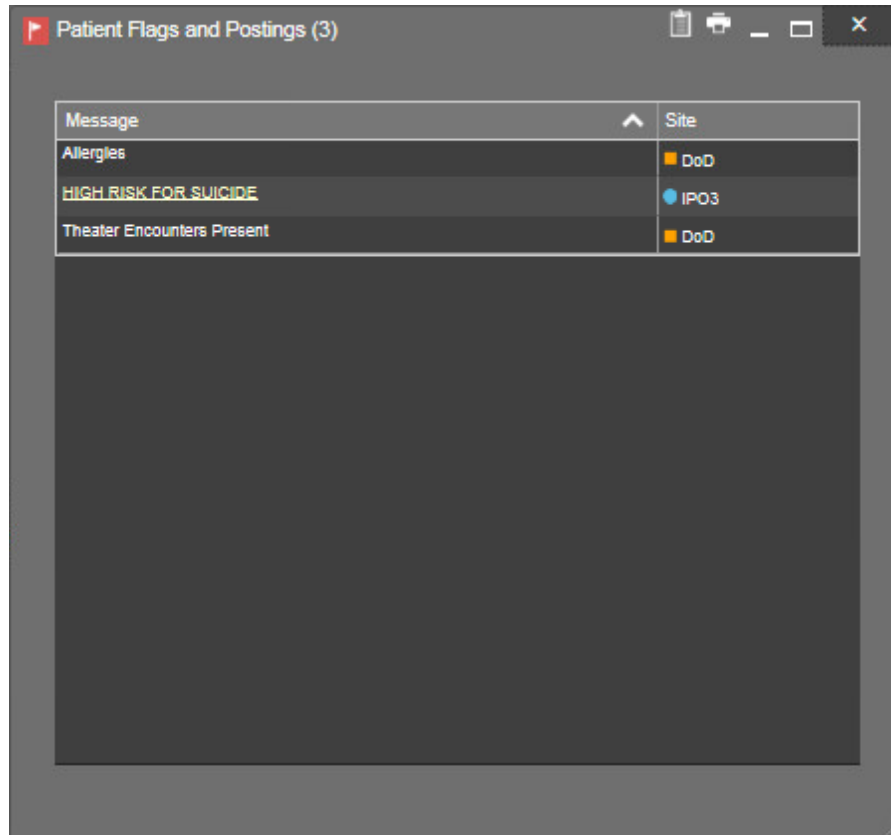



## 4.2. Customizing JLV

Configuration options can be set at the log in page level, using the **Edit Profile** link (see [Section 3.1.4, Configuration Options](#)), or within the JLV application. To access the user configuration settings within JLV, click the **cog wheel**  icon.

### 4.2.1. Setting the UI Theme

The UI theme preference is a part of the user profile. Choosing a UI theme sets the font, foreground, and background colors of the widgets, toolbars, and dialog boxes. Once selected, the UI theme is stored in the user profile, and remains set until changed.

The available UI themes can be seen in the figures below.

Figure 15: Default UI Theme

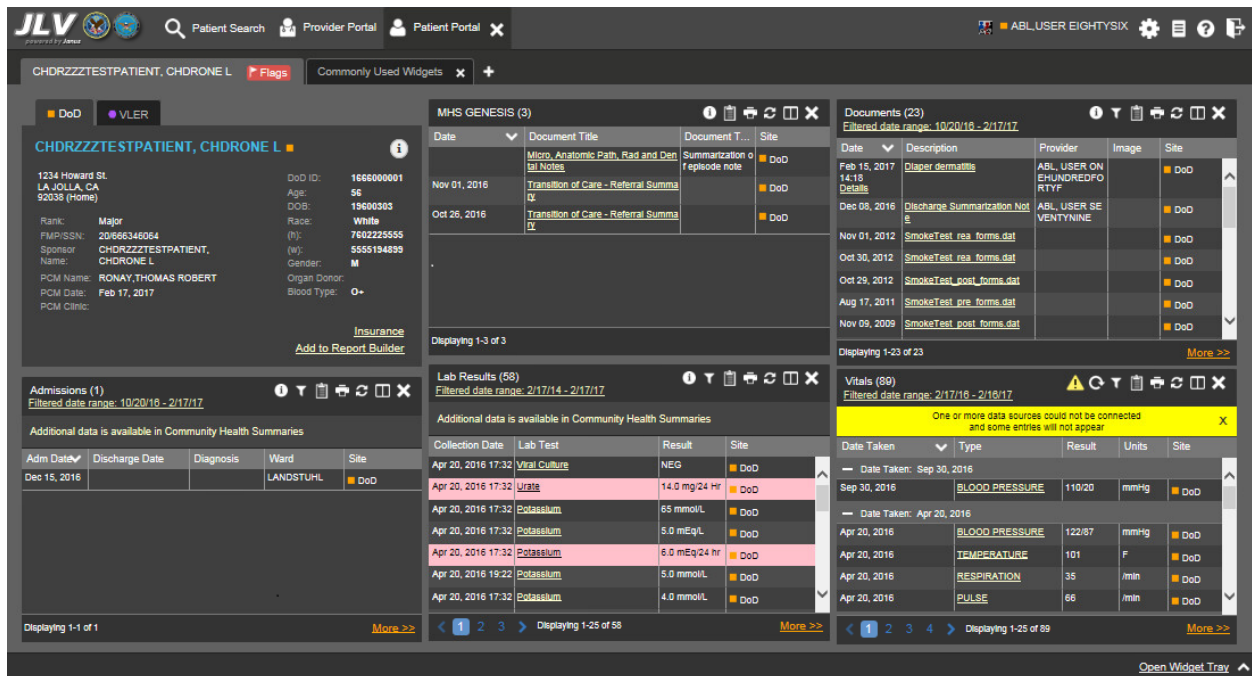

The screenshot shows the JLV application interface with the following sections:

- Header:** JLV logo, Patient Search, Provider Portal, Patient Portal, and user profile (ABLUSER EIGHTYSIX).
- Patient Information:** CHDRZZTESTPATIENT, CHDRONE L. Address: 1234 Howard St, LA JOLLA, CA 92038. Demographics: DOB: 165500001, Age: 56, Race: White, Sex: M.
- Admissions (1):** Filtered date range: 10/20/16 - 2/17/17. Table with columns: Adm Date, Discharge Date, Diagnosis, Ward, Site.
- Lab Results (58):** Filtered date range: 2/17/14 - 2/17/17. Table with columns: Collection Date, Lab Test, Result, Site.
- Documents (23):** Filtered date range: 10/20/16 - 2/17/17. Table with columns: Date, Description, Provider, Image, Site.
- Vitals (80):** Filtered date range: 2/17/16 - 2/16/17. Table with columns: Date Taken, Type, Result, Units, Site.

Figure 16: Green UI Theme

**CHDRZZZTESTPATIENT, CHDRONE L**

1234 Howard St  
LA JOLLA, CA 92038 (Home)

DoD ID: 166600001  
Age: 56  
DOB: 19600303  
Race: White  
(H): 7602225555  
(W): 5555194899  
Gender: M  
Organ Donor:  
Blood Type: O-

Rank: Major  
FMP/ISSN: 20/666346064  
Sponsor: CHDRZZZTESTPATIENT, CHDRONE L  
PCM Name: RONAY, THOMAS ROBERT  
PCM Date: Feb 16, 2017  
PCM Clinic:

[Insurance](#)

**MHS GENESIS (3)**

Date	Document Title	Document T...	Site
Nov 01, 2016	Micro, Anatomic Path, Rad and C...	Summarization o...	DoD
Nov 01, 2016	Transition of Care - Referral Summa...		DoD
Oct 26, 2016	Transition of Care - Referral Summa...		DoD

Displaying 1-3 of 3

**Documents (23)**  
Filtered date range: 10/19/16 - 2/16/17

Date	Description	Provider	Image	Site
Feb 15, 2017 14:18	Diaper dermatitis	ABL_USER ON E...		DoD
Dec 08, 2016	Discharge Summarization Not...	ABL_USER SE...		DoD
Nov 01, 2012	SmokeTest_res_forms.dat			DoD
Oct 30, 2012	SmokeTest_res_forms.dat			DoD
Oct 29, 2012	SmokeTest_post_forms.dat			DoD
Aug 17, 2011	SmokeTest_pre_forms.dat			DoD
Nov 09, 2009	SmokeTest_post_forms.dat			DoD

Displaying 1-23 of 23

**Admissions (1)**  
Filtered date range: 2/18/14 - 2/16/17

Adm Date	Discharge Date	Diagnosis	Ward	Site
Dec 15, 2016			LANDSTUHL	DoD

Displaying 1-1 of 1

**Lab Results (58)**  
Filtered date range: 1/1/99 - 2/16/17

Collection Date	Lab Test	Result	Site
Apr 20, 2016 17:32	Viral Culture	NEG	DoD
Apr 20, 2016 17:32	Urate	14.0 mg/24 Hr	DoD
Apr 20, 2016 17:32	Potassium	65 mmol/L	DoD
Apr 20, 2016 17:32	Potassium	5.0 mEq/L	DoD
Apr 20, 2016 17:32	Potassium	6.0 mEq/24 hr	DoD
Apr 20, 2016 19:22	Potassium	5.0 mmol/L	DoD
Apr 20, 2016 17:32	Potassium	4.0 mmol/L	DoD

Displaying 1-25 of 58

**Vitals (197)**  
Filtered date range: 2/18/14 - 2/16/17

One or more data sources could not be connected and some entries will not appear

Date Taken	Type	Result	Units	Site
Sep 30, 2016	BLOOD PRESSURE	110/20	mmHg	DoD
Apr 20, 2016	BLOOD PRESSURE	122/87	mmHg	DoD
Apr 20, 2016	TEMPERATURE	101	F	DoD
Apr 20, 2016	RESPIRATION	35	/min	DoD
Apr 20, 2016	PULSE	66	/min	DoD

Displaying 1-25 of 197

Figure 17: Blue UI Theme

**CHDRZZZTESTPATIENT, CHDRONE L**

1234 Howard St  
LA JOLLA, CA 92038 (Home)

DoD ID: 166600001  
Age: 56  
DOB: 19600303  
Race: White  
(H): 7602225555  
(W): 5555194899  
Gender: M  
Organ Donor:  
Blood Type: O-

Rank: Major  
FMP/ISSN: 20/666346064  
Sponsor: CHDRZZZTESTPATIENT, CHDRONE L  
PCM Name: RONAY, THOMAS ROBERT  
PCM Date: Feb 16, 2017  
PCM Clinic:

[Insurance](#)

**MHS GENESIS (3)**

Date	Document Title	Document T...	Site
Nov 01, 2016	Micro, Anatomic Path, Rad and C...	Summarization o...	DoD
Nov 01, 2016	Transition of Care - Referral Summ...		DoD
Oct 26, 2016	Transition of Care - Referral Summ...		DoD

Displaying 1-3 of 3

**Documents (23)**  
Filtered date range: 10/19/16 - 2/16/17

Date	Description	Provider	Image	Site
Feb 15, 2017 14:18	Diaper dermatitis	ABL_USER ON E...		DoD
Dec 08, 2016	Discharge Summarization Not...	ABL_USER SE...		DoD
Nov 01, 2012	SmokeTest_res_forms.dat			DoD
Oct 30, 2012	SmokeTest_res_forms.dat			DoD
Oct 29, 2012	SmokeTest_post_forms.dat			DoD
Aug 17, 2011	SmokeTest_pre_forms.dat			DoD
Nov 09, 2009	SmokeTest_post_forms.dat			DoD

Displaying 1-23 of 23

**Admissions (1)**  
Filtered date range: 2/18/14 - 2/16/17

Adm Date	Discharge Date	Diagnosis	Ward	Site
Dec 15, 2016			LANDSTUHL	DoD

Displaying 1-1 of 1

**Lab Results (58)**  
Filtered date range: 1/1/99 - 2/16/17

Collection Date	Lab Test	Result	Site
Apr 20, 2016 17:32	Viral Culture	NEG	DoD
Apr 20, 2016 17:32	Urate	14.0 mg/24 Hr	DoD
Apr 20, 2016 17:32	Potassium	65 mmol/L	DoD
Apr 20, 2016 17:32	Potassium	5.0 mEq/L	DoD
Apr 20, 2016 17:32	Potassium	6.0 mEq/24 hr	DoD
Apr 20, 2016 19:22	Potassium	5.0 mmol/L	DoD
Apr 20, 2016 17:32	Potassium	4.0 mmol/L	DoD

Displaying 1-25 of 58

**Vitals (197)**  
Filtered date range: 2/18/14 - 2/16/17

One or more data sources could not be connected and some entries will not appear

Date Taken	Type	Result	Units	Site
Sep 30, 2016	BLOOD PRESSURE	110/20	mmHg	DoD
Apr 20, 2016	BLOOD PRESSURE	122/87	mmHg	DoD
Apr 20, 2016	TEMPERATURE	101	F	DoD
Apr 20, 2016	RESPIRATION	35	/min	DoD
Apr 20, 2016	PULSE	66	/min	DoD

Displaying 1-25 of 197

Figure 18: Gray UI Theme

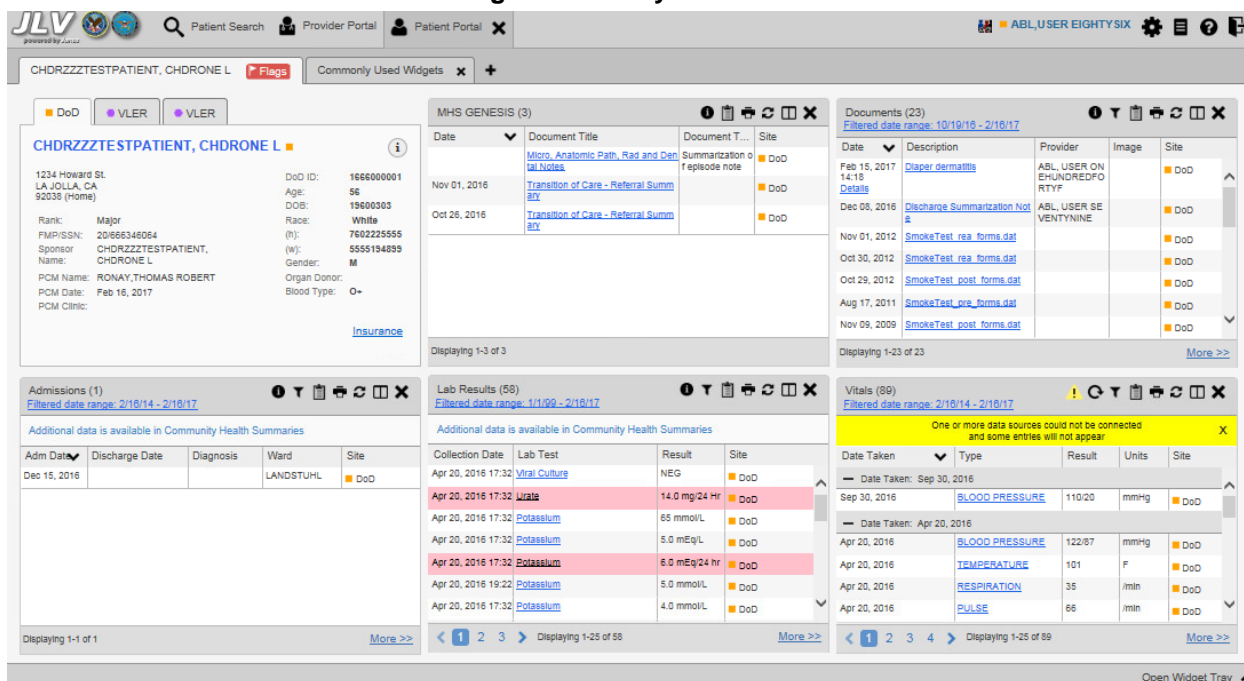
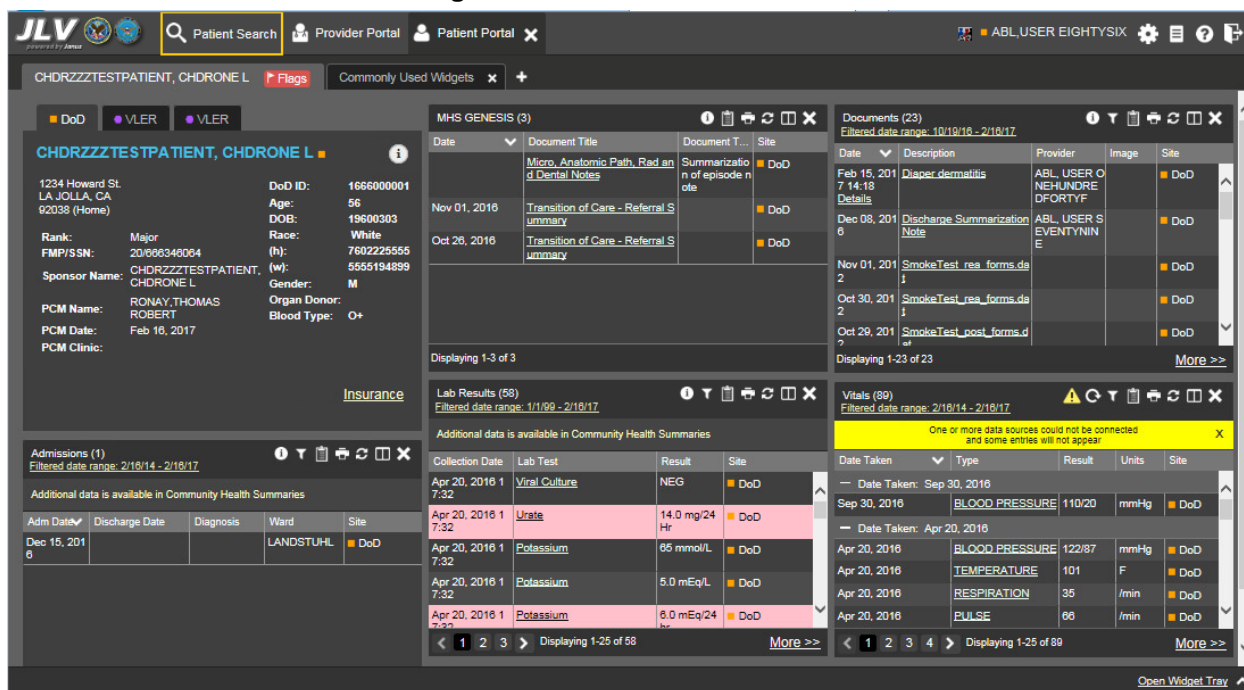

Figure 19: Accessible UI Theme



## 4.2.2. Working with the Accessible Theme

Users who need to utilize the accessibility features of JLV can select the Accessible UI theme from the log in page, or within JLV.



The Accessible theme includes larger fonts, enhanced tab and keystroke functionality, and screen reader compatibility for users needing accommodation to support Federal accessibility requirements and Section 508 compliance. The Accessible theme is available for users who have adaptive technologies installed on their computers.

To set the Accessible theme after logging in:

1. Click the **cog wheel**  icon in the upper right corner of the JLV portal pages ([Figure 7](#))
2. The **User Configuration** dialog box opens
3. Select **Accessible** and click **Save**
4. After clicking **Save**, click **Yes** to reload the application and to apply the settings.
5. Alternatively, click **Cancel** to exit the dialog box and restore the UI to the previous theme

### 4.2.3. Keyboard Focus and Screen Navigation

Keyboard focus is the highlighting of screen elements that enables interaction with and navigation of the web application through the keyboard and keystrokes. The GUI element that has keyboard focus is outlined. JLV uses a gold border or outline as a visual indicator of which element has current keyboard focus.

#### 4.2.3.1. Keyboard Shortcuts

JLV uses Windows keyboard shortcuts (i.e., Tab, Shift + Tab, arrow keys, Enter, etc.) and other keystrokes to move the focus to, and activate, all menus and functions ([Table 5](#)).

Pressing Enter, when an element that provides action is in keyboard focus, executes the associated action. For example, pressing Enter when the **cog wheel**  icon is in keyboard focus opens the **User Configuration** dialog box. Use the arrow keys or the Tab key to move between keyboard focus and navigate through the elements on the screen.

**Table 5: Accessible Theme Keyboard Shortcuts**

Keystroke	Description
<b>Application &amp; Portal Navigation</b>	
ENTER	Press to transfer keyboard focus to the highlighted widget.
TAB	Press to transfer keyboard focus to other user interface items.
ESC	Press to return keyboard focus to the panel containing the user interface item with keyboard focus or to exit a window or widget.
SPACEBAR	Press to activate any user interface item (for example, click a button).
Arrow Keys	When focused on a widget, press the arrow keys to change page viewing in a widget's data table. When keyboard focus is on a drop-down list, press the down arrow to view the contents.
Ctrl + p	Press to bring focus to the first tab in the active portal (either provider or patient).

Keystroke	Description
Ctrl + r	When working with the Report Builder, place keyboard focus on a record in a widget and then press Ctrl + r to add the record to the Report Builder tool.
<b>Tab Panels</b>	
Arrow Keys	Use the left and right key buttons to change tab panels. To add a tab panel, press the right key until the last tab (labeled with a plus sign) is selected. A dialog will prompt for the tab name. To close a tab, focus on the tab panel and press Ctrl + x.
<b>Windows or Dialog Boxes</b>	
TAB	Press the TAB key to move the keyboard focus to other user interface items within the window.
<b>Adding Widgets to the Onscreen Portal</b>	
SHIFT + (Number position)	To add a widget from the widget tray using keystrokes: <ol style="list-style-type: none"> <li>1. First determine which column (1, 2, or 3) to place the widget onscreen.</li> <li>2. Focus the desired widget icon from the widget tray and press the SHIFT key along with the 1, 2, or 3 key, depending on the column chosen.</li> </ol>

#### 4.2.3.2. Accessible Theme Screen Navigation

An element with keyboard focus is the starting point for screen navigation. Pressing the **Enter** key when a screen element or icon has keyboard focus mimics a mouse click.

In [Figure 20](#), the **Documents** widget has keyboard focus. Focus can be changed by pressing the **Tab** key. In this example, pressing the **Tab** key shifts the keyboard focus from the **Documents** widget to the **Procedures** widget (below the Documents widget in the figure). Pressing the **Tab** key again shifts the keyboard focus to the **Radiology Reports** widget, as in this sample configuration, there are no widgets below the **Procedures** widget.



To view hover text where available in the JLV interface, focus on the element within the widget that has hover text. After a small delay, the text will appear as if the user hovered over the element with a mouse cursor.

Figure 20: Navigation Using Elements with Keyboard Focus

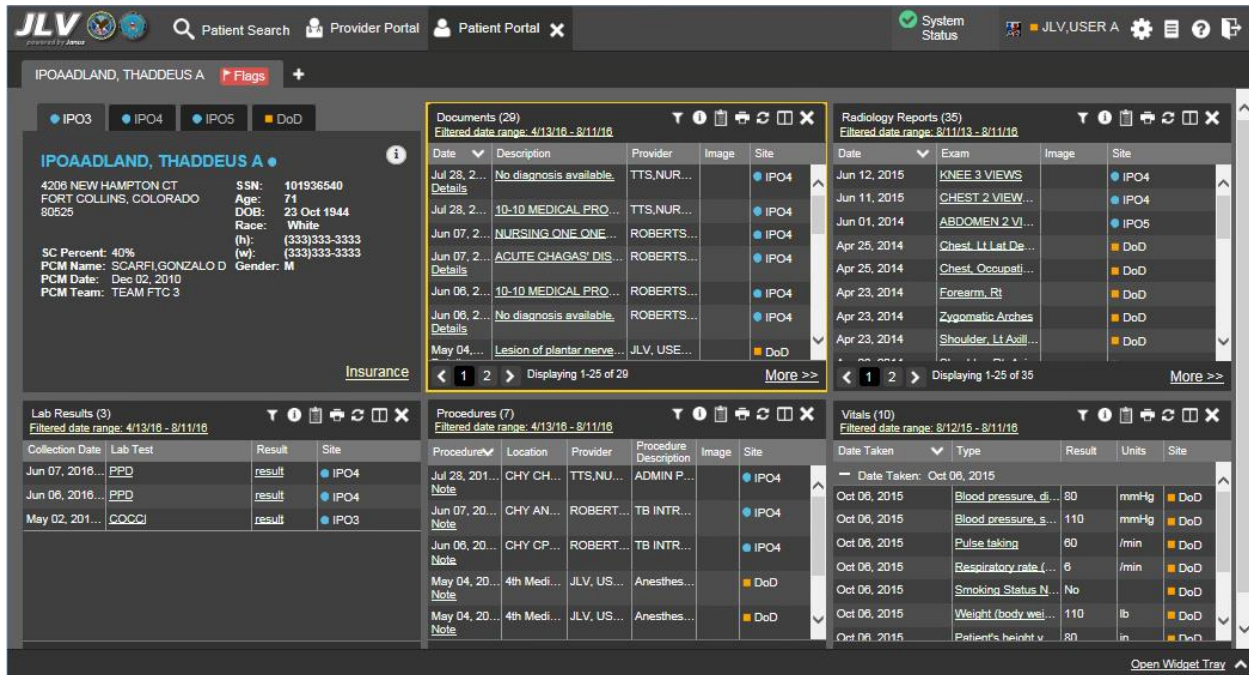

In [Figure 21](#), the IPO3 tab of the Patient Demographics details window has keyboard focus. Move through the tabs (IPO4, IPO5, or DoD) by using the arrow keys, or by pressing **Tab**. Move to the patient name and press **Enter** to open the details view of patient demographics.

When the patient's name has keyboard focus, press the up and down arrow keys to scroll through the contents of the window.

Figure 21: IPO3 Tab with Keyboard Focus

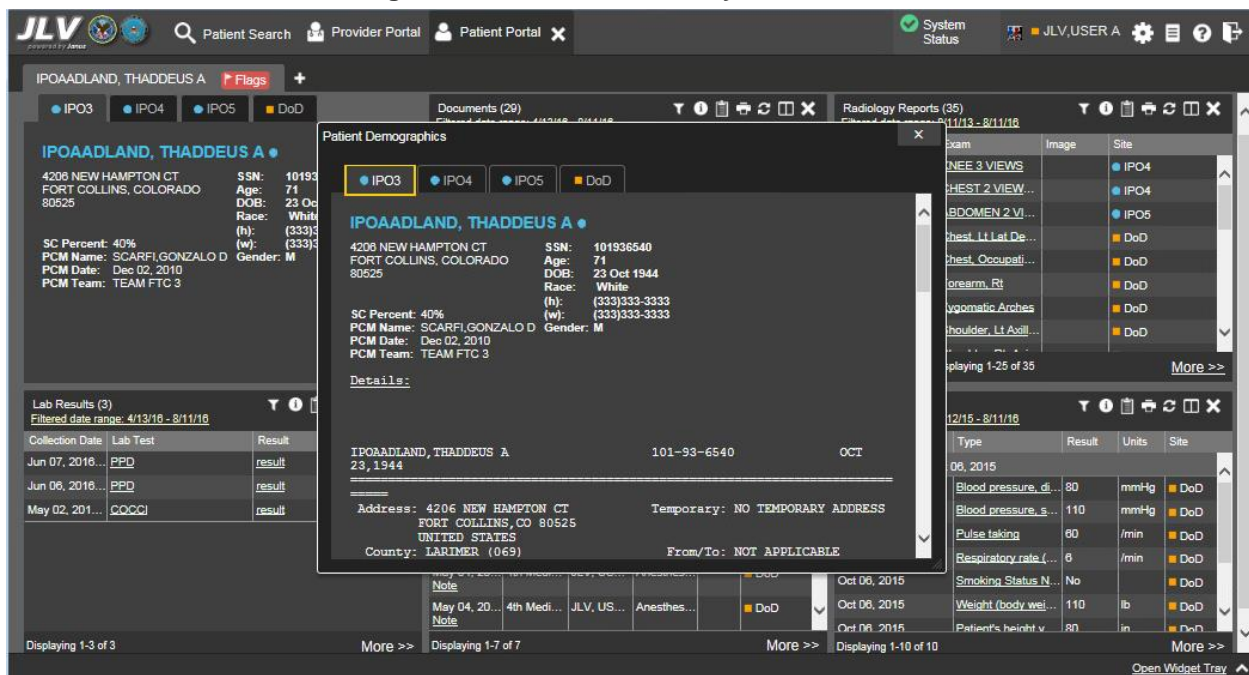

When keyboard focus is on the **Close X** button in a widget or window (Figure 22), press **Enter** to close that widget or window. After closing the window, keyboard focus returns to the last element that had keyboard focus prior to opening the window.

**Figure 22: Close Button with Keyboard Focus**

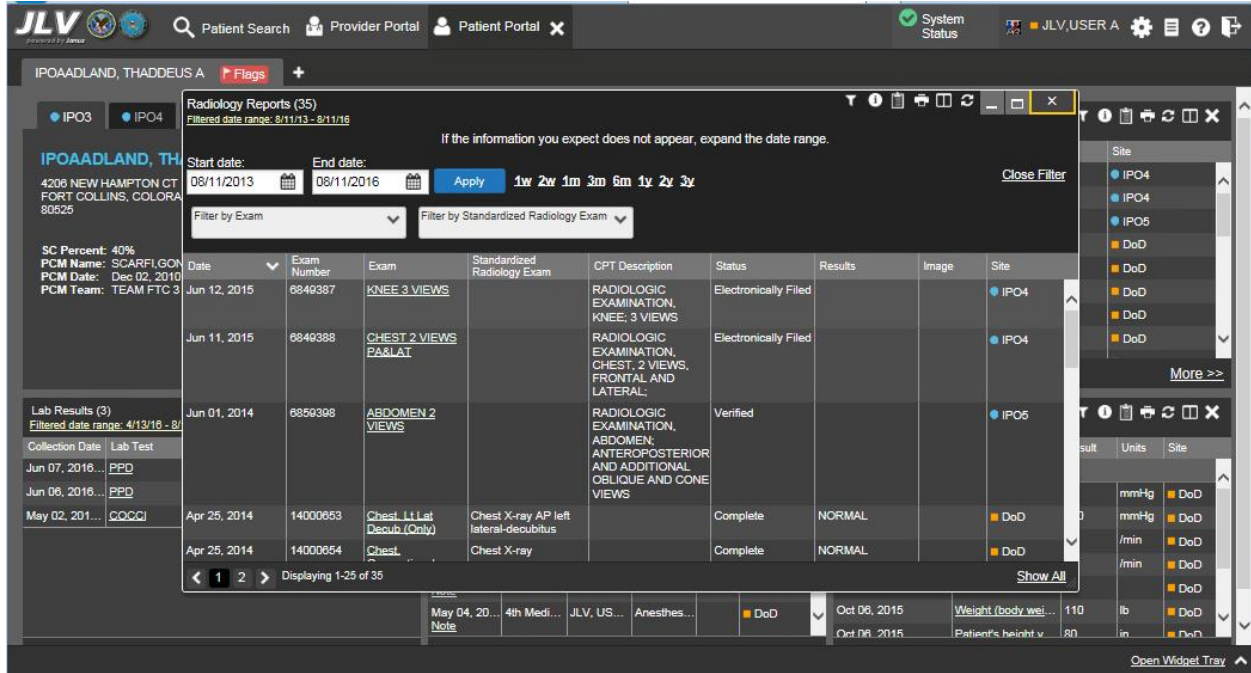

#### 4.2.4. Creating Custom Tabs

For ease of use and quick reference, use the Tabs feature to create custom widget configurations on the portal.

To create a custom tab:

1. Click the plus sign + next to the existing tabs in the upper left corner of the portal page (Figure 23). The **Add Tab** dialog opens
2. Type the name of the new tab in the **Add Tab** dialog and click **OK**

**Figure 23: Add New Tab**

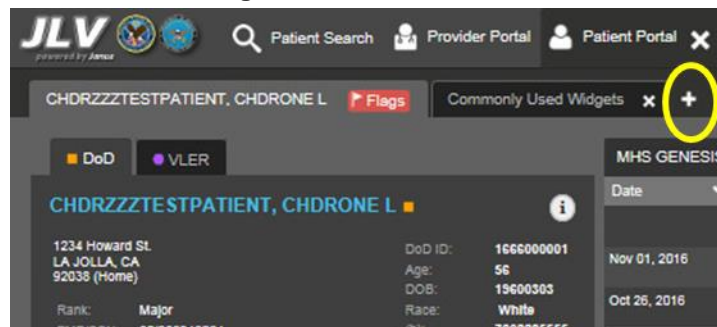

3. Use the **Open Widget Tray** link to display available widgets
4. Click and drag the desired widgets to the portal page

**i** Tab configurations remain as set throughout the current, and subsequent, JLV sessions, until manually changed.

5. To switch between portal tabs, click the name of the tab you want to display

### 4.3. Working with Widgets

Widgets are elements on the JLV portal pages that display data specific to a clinical domain. By default, widgets are displayed in minimized view on the portal pages, but can be expanded to view additional details. The list of available widgets is provided in a horizontal tray at the bottom of the page ([Figure 24](#)).

**i** Widgets may take anywhere between 3 seconds to 10 seconds to load.

**Figure 24: Widgets on the Patient Portal**

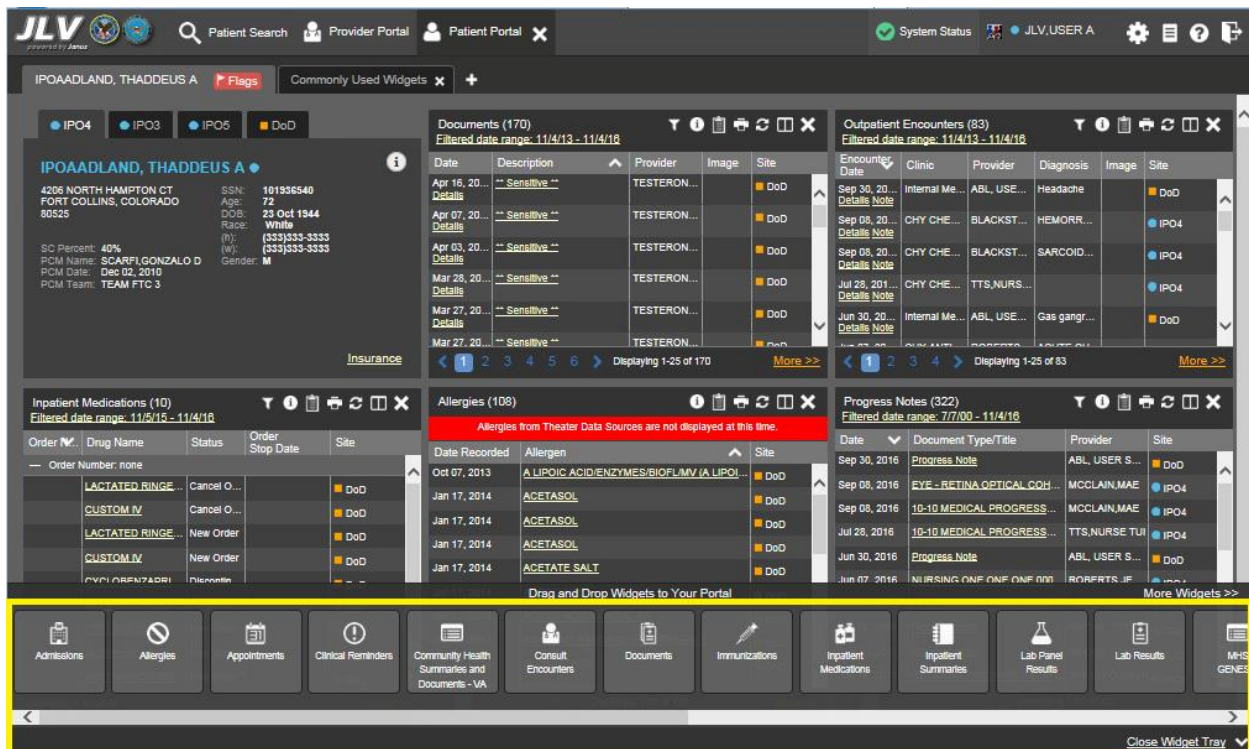

#### 4.3.1. Opening and Closing Widgets

Widgets can be opened, closed, and rearranged on the portal pages. Available widgets are located in the widget tray, at the bottom of the portal pages ([Figure 25](#)).



**Figure 25: Widget Tray on the Patient Portal**

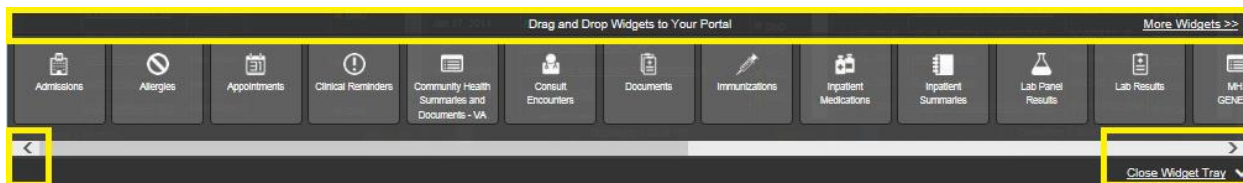

To place a widget on the Patient Portal:

1. Open the widget tray by clicking the **Open Widget Tray** link, or clicking the **Expand** ^ icon
  2. Use the scroll bar arrows < > to see all widget choices
- OR-**
3. Click the **More Widgets** link to scroll through the list of widgets
  4. Drag and drop the widget from the tray onto the portal page
  5. The widget is docked on the portal page, and opens in minimized view
  6. Close the widget tray by clicking the **Close Widget Tray** link

Widgets can be removed by clicking the **Close** icon ✕ in the top right corner, and re-arranged on the portal page, as desired, using drag and drop actions.

### 4.3.2. Minimized and Expanded Views

Each widget can be displayed in either a minimized (default) or an expanded view. Minimized view displays a short list of the available patient data for a clinical domain, arranged in reverse chronological order. Expanded view provides a longer list of similarly arranged patient data. When the expanded view of a widget is launched, it opens in a new, separate window.



The Community Health Summaries and Documents - VA widget does not have an expanded view. Instead, a list of the documents available for viewing is displayed in a new, separate window.

Click the **More >>** link at the bottom of a widget to launch the expanded view, and see additional display and functionality options.

The patient data displayed within a widget can be filtered by date range. If a date range filter is applied, the selected range is indicated in the widget header, below the title. Click the Configure Filter ☂ icon, or the **Filtered Date Range** link on the widget toolbar to change the date range of the data displayed ([Figure 26](#)).

Figure 26: Minimized Widgets with Date Range Filter Applied

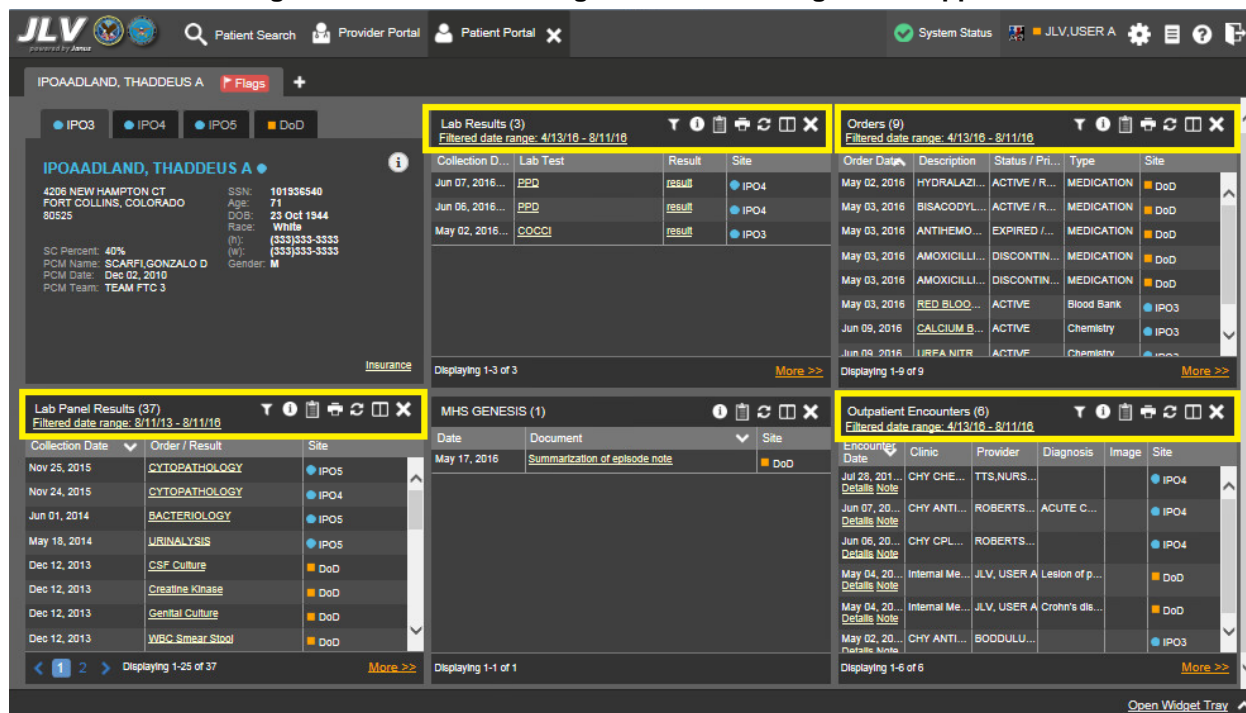









### 4.3.3. Widget Toolbars

Toolbars are provided in the upper right corner of both the minimized and expanded views of each widget, and most dialog boxes. Toolbar icons vary by widget, open dialog box, and window. [Table 6](#) describes the functionality of each toolbar icon.

Table 6: Widget Toolbar Icons

Icon	Name	Function
	Add to Report Builder	Adds the information displayed in the window to the Report Builder. This icon is available for supported domains when a record has a Details or Notes view that displays in a standalone window.
	Close	Removes the widget from the portal screen or closes a dialog box.
	Column Settings	Used to configure the columns within the widget. Turn on or off the columns displayed by checking the column names that appear in the pop-up box and checking <b>Apply</b> .
	Configure Filter	Used to filter on specific record types or other elements within the widget, including a date filter. If a date range filter is applied in an open widget, the date range is displayed in the widget header. <b>Note:</b> After setting a filter, the <b>Close Filter</b> option is enabled in the widget. Clicking <b>Close Filter</b> will restore the full display of records within the widget.
	Copy to Clipboard	Copies the content of the open window to the clipboard for pasting into another application.

Icon	Name	Function
	Interface Status	Both icons provide a status indicator for DoD, VA, and community partner data sources. The circle with the lowercase “i”  indicates all sources are available. The yellow triangle warning  indicates one or more data sources are unavailable. Clicking either status icon will open the interface status details in a separate window. <b>Note:</b> Interface status updates are not available from the <b>Clinical Reminders</b> widget.
	Print	Prints the contents of the open window. Printing is disabled in the widget toolbar after clicking <b>Show All</b> within a widget. <b>Note:</b> It is recommended that JLV users have the latest Adobe Reader installed for the Report Builder and other printing features..
	Refresh	Refreshes the widget or window display. Only the data within that widget’s dataset is updated.
	Rx	Converts the medication data within the widget to text, and opens the text in a pop-up window. Available from the <b>Outpatient Medications</b> widget.
	Site List	Opens a list of community sites where the patient has been seen (only available from the <b>Community Health Summaries and Documents – VA</b> widget).
	VLER Refresh	Refreshes VLER-enabled widgets with the community partner data stored in the VLER cache, in addition to refreshing DoD and VA data. <b>NOTE:</b> The VLER Refresh icon is shown in VLER-enabled widgets <i>only</i> when <b>Include Community Data</b> is enabled.

#### 4.3.4. Refreshing Data in a Widget

Data displayed in a widget can be refreshed by clicking the **Refresh**  icon. This action will refresh the widget’s VA/DoD data display. When the option to **Include Community Data** is enabled, clicking the **Refresh** icon also triggers a refresh of the VA VLER-enabled widgets’ data.

A widget will display the **VLER Refresh** icon  if the widget supports community partner data, and the **Include Community Data** option is enabled. Clicking the **VLER Refresh** icon triggers two refresh actions: JLV sends a new query to VLER sources for community partner data, then refreshes DoD and VA data in open widgets with data JLV has stored in a cache. Clicking **VLER Refresh** in one widget refreshes all other open, VLER-enabled widgets.



If the option to **Include Community Data** is disabled, the **VLER Refresh** icon will not be displayed in any of the widgets that support the display of community data.

#### 4.3.5. Widget Navigation and Display Options

There are tools and display options available within each widget. Their functionality allows the user to navigate through and change the display of data results available in the widget’s minimized and expanded views. A vertical scroll bar allows the user to scroll through, and view,

the data. Options at the bottom of the widget allow for navigation through all records loaded for the widget's clinical domain.

The functionality for the navigation tools shown in the following sample widget is further explained in [Table 7](#).

**Table 7: Navigation Icons and Actions**

Navigation Icon/Action		Description
<	Go to Previous Page	Changes the focus of the widget to the previous group or page of records within the results display.
1	Jump to Page	Changes the focus of the widget to the page number selected.
>	Go to Next Page	Changes the focus of the widget to the next group or page of records within the results display.
More >>	Go to Expanded View	Available in minimized views only. Opens the expanded view of the widget in a secondary window.
1-25 of 55	Record Display Indicator	Indicates the number of records displayed in that widget page out of the total number of results for that widget.
Show All/ Show Paged	Display Setting	Click <b>Show All</b> to open all records for a given widget in a scrollable window. Click <b>Show Paged</b> to return to the display of records grouped by pages.

In [Figure 27](#), there are 55 total records available in the **Lab Panel Results** widget, grouped in the **Show Paged** view. Records 1 through 25 can be viewed by using the widget's vertical scroll bar. Records 26 - 55 can be viewed by using the page navigation options in the lower left corner of the widget, to jump to subsequent pages. A widget open in expanded view contains a **Show All** link, which opens all records for a given widget in a scrollable window. Click **Show Paged** to return to the display of records grouped by pages.

Figure 27: Widget Navigation Tools

The screenshot shows a web interface for 'Lab Panel Results (55)'. At the top, it displays a filtered date range of 8/10/13 - 8/10/16. Below this, there are date selection fields for 'Start date' (08/10/2013) and 'End date' (08/10/2016), with an 'Apply' button and preset filters for 1w, 2w, 1m, 3m, 6m, 1y, 2y, and 3y. A 'Close Filter' link is also present. A dropdown menu allows filtering by 'Order /Results'. The main area is a table with the following data:

Collection Date	Order Number	Order / Results	Ordering HCP	Ordering HCP Specialty	Sample	Status	Site
Jun 16, 2015 19:12		<a href="#">SURGICAL PATHOLOGY</a>	MYERS,ANGELA M	Allopathic and Osteopathic Physicians	RIGH, ARM	Incomplete	IPO4
Jun 16, 2015 18:19		<a href="#">SURGICAL PATHOLOGY</a>	MYERS,ANGELA M	Allopathic and Osteopathic Physicians	LEFT	Incomplete	IPO4
Jun 12, 2015 09:29	5587698	<a href="#">A1C-CHY</a>	MYERS,ANGELA M	Allopathic and Osteopathic Physicians	BLOOD	completed	IPO4
Jun 08, 2015 10:16	5587621	<a href="#">CHEM 7-R</a>	MYERS,ANGELA M	Allopathic and Osteopathic Physicians	SERUM	completed	IPO4
Jun 08, 2015 10:16	5587620	<a href="#">SODIUM</a>	MYERS,ANGELA M	Allopathic and Osteopathic Physicians	SERUM	completed	IPO4
Apr 04, 2014 17:01	140404-00001	<a href="#">Calcium</a>	TESTERONE, IQA		BLOOD	Final	DoD
Apr 02, 2014 21:25	140402-00009	<a href="#">Calcium</a>	TESTERONE, IQA		BLOOD	Final	DoD
Apr 02, 2014 19:46	140402-00007	<a href="#">Calcium</a>	TESTERONE, IQA		BLOOD	Final	DoD
Apr 02, 2014 18:52	140402-00005	<a href="#">Calcium</a>	TESTERONE, IQA		BLOOD	Final	DoD
Apr 02, 2014 18:34	140402-00003	<a href="#">Calcium</a>	TESTERONE, IQA		BLOOD	Final	DoD

At the bottom, there are navigation arrows and a status bar indicating 'Displaying 1-25 of 55' with a 'Show All' link.

### 4.3.6. Date Range Filters

There are two ways to filter the date range of data displayed in JLV; the **Quick Date Range** filter, and the **Start and End Date** filter. If the expected information does not appear in the widget display, use the date filter options to change the date range.



Changes made to the date range in a widget persist from patient to patient, and session to session, until the widget is either removed, or the date range is changed.

#### 4.3.6.1. Quick Date Range Filter

Use the preset, **Quick Date Range** filter to set or limit the display of patient records within a particular widget. This option is available in multiple widgets on the Patient Portal.

Clicking a date range will refresh the display to show only the records for the selected range. The options represent time counting back from the present day (for example, selecting 2y will display only records within the last two years). Examples of preset date ranges include 1w (last 7 days), 6m (last 6 months), and 3y (last 3 years).



The **Quick Date Range** filter is contextual. If today is January 2, 2017, the preset filters will count backwards using that date. If today is April 16, 2017, the preset filter will count backwards using that date.

[Figure 28](#) highlights the Quick Date Range filter options in the expanded view of the **Orders** widget.

**Figure 28: Quick Date Range Filter Options**

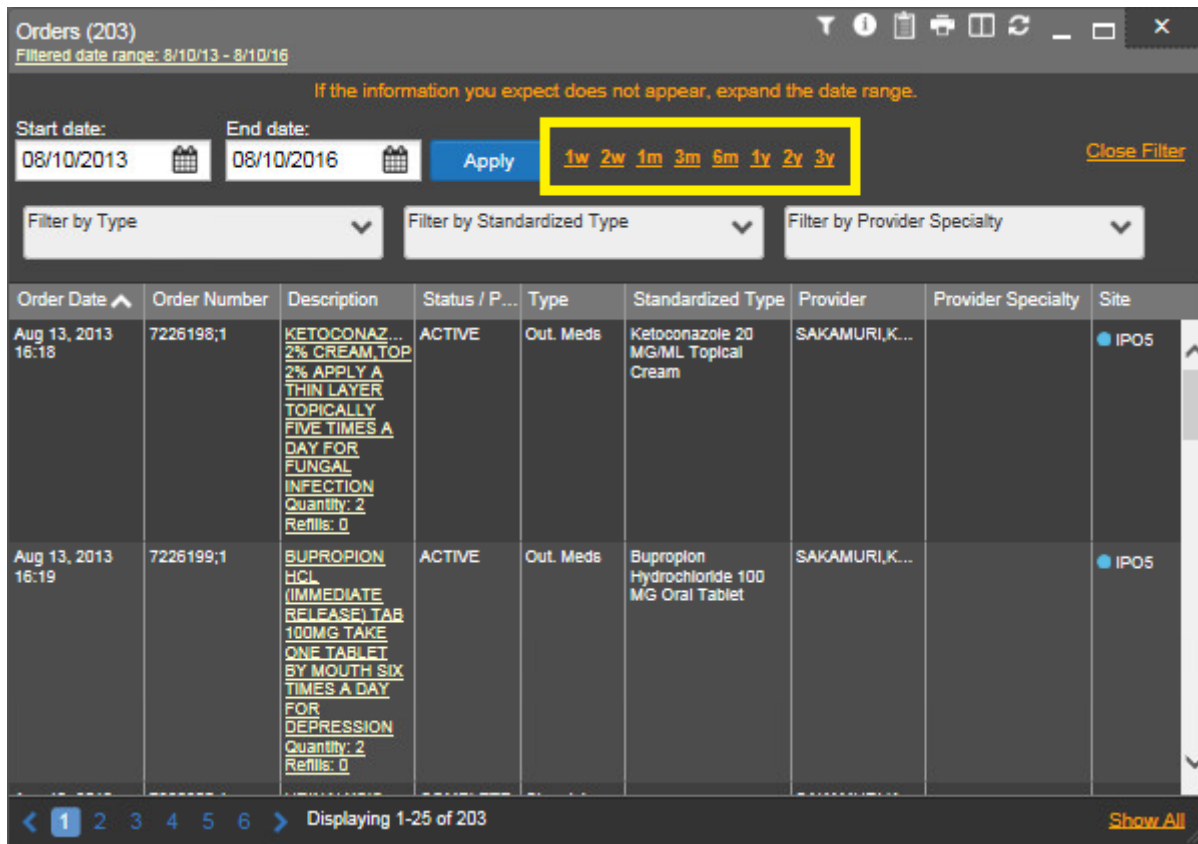

#### 4.3.6.2. Start and End Date Filter

Use the **Start Date and End Date** filter to display data for a specific time range. These start and end date fields are available at the top of multiple widgets in expanded view, or by clicking the **Configure Filter**  icon in minimized view.





The **Start and End Date** filter is static. If the start date is set to June 2, 2016 and the end date is set to June 2, 2017, the data in that date range will display, no matter what today's date is.

[Figure 29](#) provides an example of the start and end date filter fields in the expanded view of the **Radiology Reports** widget.

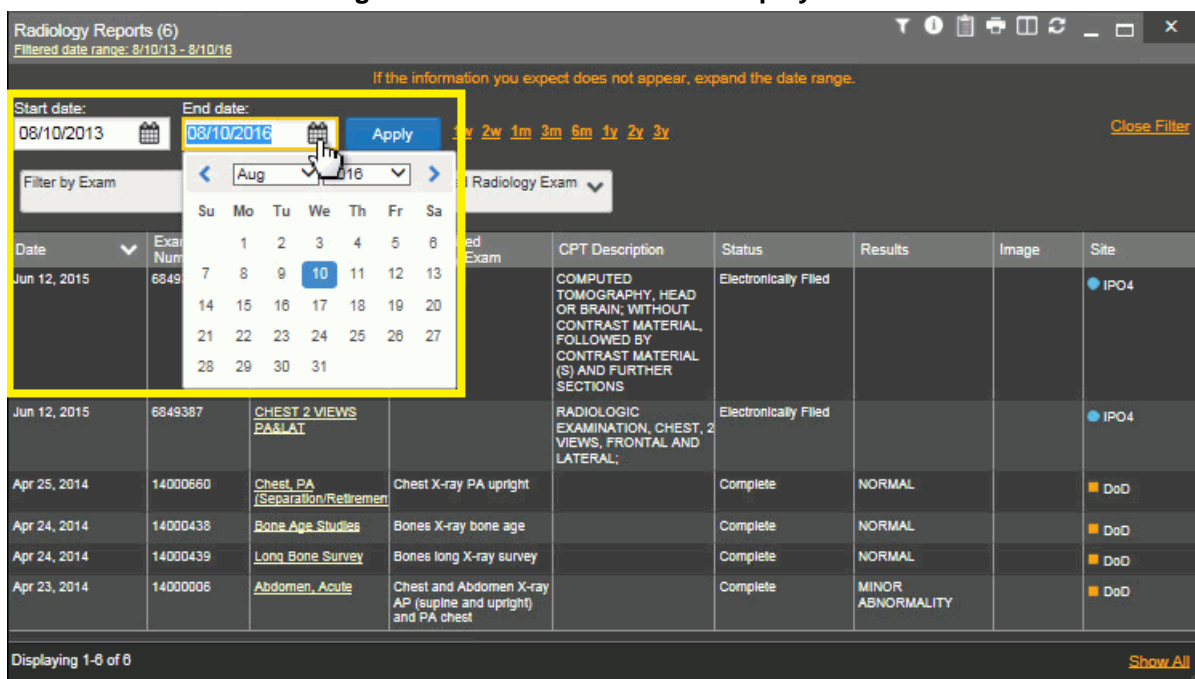
Figure 29: Start and End Date Display Filter



To set a custom date range:



1. Click the **Calendar** icon  next to **Start Date**
2. Choose a start date for the display filter
3. Click the **Calendar** icon  next to **End Date**
4. Select the end date for the display filter
5. When both a start and end date have been chosen, click **Apply**

The widget refreshes and displays only the records that fall within the custom date range. The date range in use is displayed in the widget header.

### 4.3.7. Context Management

Clinical Context Management (also referred to as CCOW) is a way for applications to synchronize the display of clinical context based on the Health Level 7 CCOW standard. If CCOW-compliant applications are sharing context and one of the applications changes the data display to a different patient, the other applications will switch to display that same patient.

JLV is context management-enabled. When context is enabled, a patient change triggered in one context-enabled application (i.e., CPRS) will cause the same change in JLV. The same effect is shown vice versa; that is, when a patient is selected in JLV, it triggers a patient change in other context-enabled applications.

Context management is enabled by default, and JLV will attempt to connect to the context vault upon a valid login. The context status appears in the top right corner of all JLV screens. When context is established, the **Context On** icon  is shown. When context is suspended, the **Context Suspended** icon  is shown.

[Figure 30](#) shows the context indicator location on a JLV portal page. In this example, context is suspended.

**Figure 30: Context Indicator on the JLV Portal Pages**

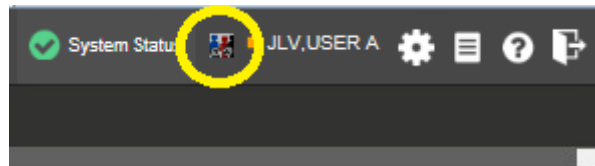

#### 4.3.7.1. Unable to Communicate with Vault

If JLV is unable to initiate context management upon log in, the user will see the CCOW Error message in [Figure 31](#). Click **OK** to continue. The **Context Suspended** icon  is displayed on the JLV portal pages.

**Figure 31: CCOW Error Message**

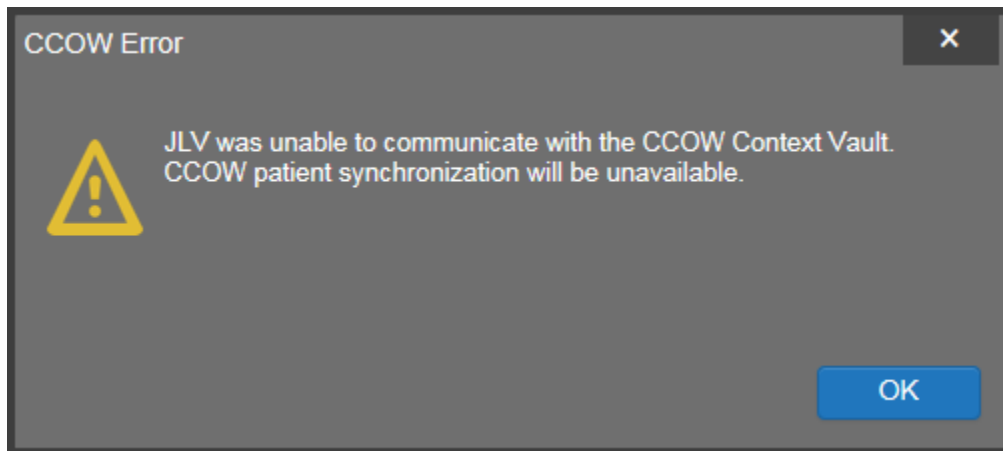

#### 4.3.7.2. Establishing Context

When context is suspended, it can be re-established manually.

To establish or re-establish context:

1. Click the **Context Suspended** icon 
2. The CCOW warning message, *Are you sure you want to rejoin patient link?* appears ([Figure 32](#))
3. Click **Yes**

Once context is established, the **Context On** icon  is displayed on the JLV portal pages.



Figure 32: CCOW Warning Message

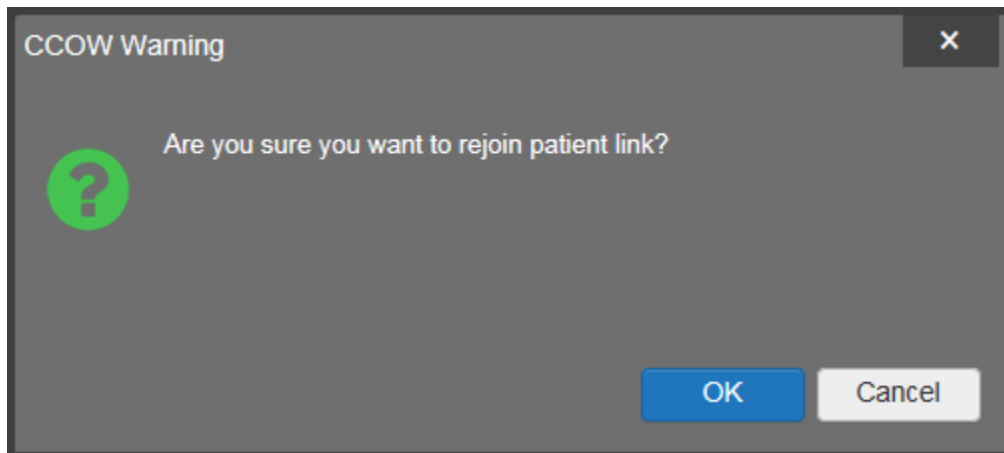

#### 4.3.7.3. Context Synchronization Failure

In the event that JLV is unable to re-establish context, the user is presented with a CCOW Error message seen in [Figure 33](#). This indicates context is suspended. Click **OK** to continue. The **Context Suspended**  icon is displayed on the JLV portal pages.

Figure 33: Context Synchronization Failure



#### 4.3.7.4. Suspending Context

Context can be manually suspended.

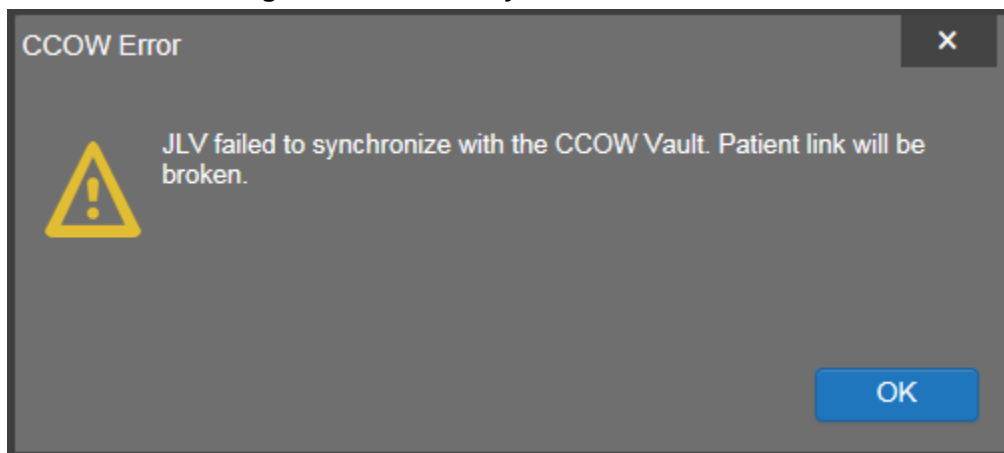
To manually suspend context:

1. Click the **Context On** icon 
2. The CCOW warning message, *Are you sure you want to break patient link?* appears ([Figure 34](#))
3. Click **Yes** to continue

Once context is suspended, the **Context Suspended** icon  is displayed.

Figure 34: Suspending Context

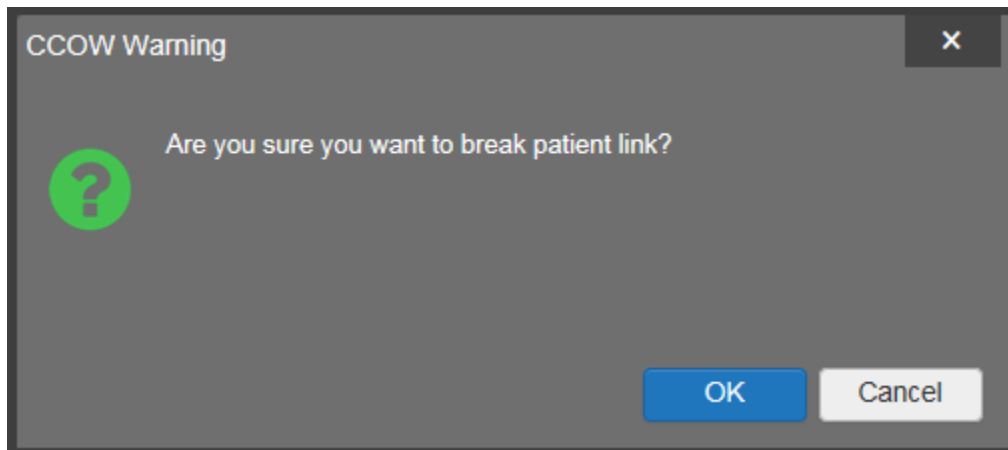

## 4.3.8. User-Restricted Access to Patient Data

### 4.3.8.1. VHA Users Viewing DoD-only Patients

VHA users are permitted to view the records of DoD-only patients (i.e., there are no VA identifiers, or the patient is not registered in MVI), but the VA requires that these actions be audited. If an attempt is made to access DoD-only patient records, the VHA user is asked to specify the purpose for access. The purpose options presented to the user are: Emergent Care, Clinical Care, or Authorized Administrative Use ([Figure 35](#)).

After selecting the purpose for access, and clicking **Agree to be Audited & Access this Patient Record** ([Figure 35](#)), the requested data is displayed, and an audit is performed. The access purpose, organization of the VA provider, date, user name, IP address, user's Internal Entry Number (IEN), host system's ID, and patient's Electronic Data Interchange Personal Identifier (EDIPI) are audited.

Figure 35: VA User Restricted Access Dialog



#### 4.3.8.2. VBA Users Viewing DoD-only Patients

VBA users may see two different dialog boxes, depending on whether or not the patient is registered in MVI.

- **Patient registered in MVI:** VBA users are permitted to view the records of a patient who is registered in MVI, but the VA requires that these actions be audited. After performing a patient search and selecting a patient from the search results, a VBA user will see the audit notification ([Figure 36](#)) if the patient they selected is registered in MVI. After agreeing to the audit, the VBA user can access the patient's record.

**Figure 36: VBA User Audit Notification**



- **Patient not registered in MVI:** VBA users are not permitted to access the records of a patient who is not registered in MVI. After performing a patient search and selecting a patient from the search results, a VBA user will see the restricted access notification ([Figure 37](#)) if the patient selected is not registered in MVI. Clicking **Cancel** returns the user to the previous screen.

**Figure 37: Restricted Access Notification**

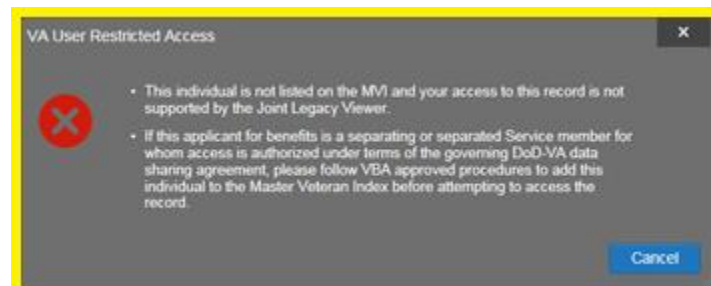

#### 4.3.8.3. Access to DoD Sensitive Records

All JLV users are audited each time a sensitive DoD record is accessed. Auditing applies to sensitive outpatient encounters, progress notes, or labs results records. For each attempt to access

sensitive data, JLV records the user’s organization, user name, user Social Security Number (SSN)/EDIPI (for DoD users), user PIV (for VA users), user location, patient identifiers (patient last name, first name, middle initial (MI), SSN/EDIPI (DoD only), MVI (VA only), and date of birth (DOB)), data accessed, date and time, and reason for access. Information is sent to, and stored in, the JLV database for use by System Administrators to create audit reports.



The audit prompt is seen each time access to a sensitive record is attempted, even if the user has been previously audited for the same record.

JLV notifies users before they are audited. The message is triggered when the user clicks a masked record that is marked **\*\* Sensitive \*\***. An example of a masked record displayed in a widget and the audit notification are depicted in [Figure 38](#).

After the user selects the purpose for viewing the record and agrees to be audited, the sensitive data is displayed in the **Details** view of the widget.

**Figure 38: DoD Sensitive Record and Audit Dialog**

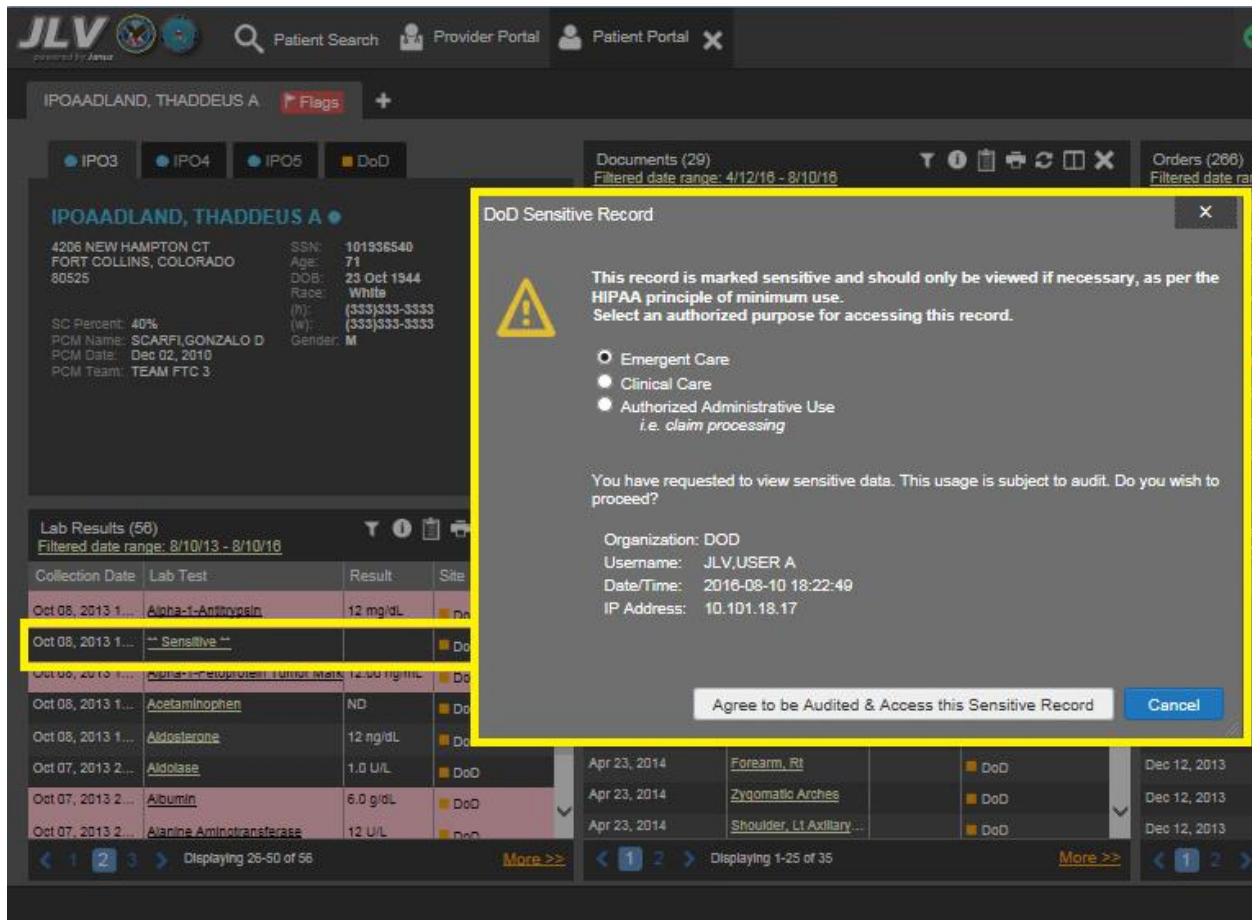

## 4.3.9. Using Report Builder

The Report Builder feature provides the ability to build custom reports by selecting patient records, or combination of supported documents and record details. The information selected for the custom report is exported to a printable file in Portable Document Format (PDF).



As noted in [Section 2, System Summary](#), it is recommended that the latest version of the Adobe Reader be installed on the system used to access JLV.

### 4.3.9.1. Creating Reports

Reports can be built using patient records, and/or documents from the minimized or expanded view of a supported widget. The **Report Builder** feature can be accessed from the toolbar at the top right corner of the Patient Portal.

To create a report:

1. Click the **Report Builder** icon  (Figure 39). The **Report Builder** window opens on the Patient Portal (Figure 40)

Figure 39: Report Builder Icon on the Portal Toolbar



2. Select records to add to the report:
  - Any record or demographics data within a widget can be added by right-clicking the entry in an open widget and selecting **Add Record to Report** (Figure 40)
  - Click **Add to Report** within any **Demographics** tab to add demographics data. Demographics information will appear at the top of the report by default
  - If the desired record has a **Details** or **Notes** view, click the **Add Record** icon  on the toolbar of the open **Details** or **Notes** window to add the additional record information
    - Some DoD notes cannot be added to **Report Builder**. If a note cannot be added, there will not be an option on a right-click to add the record to the report

Figure 40: Report Builder Window & Add Record to Report Option

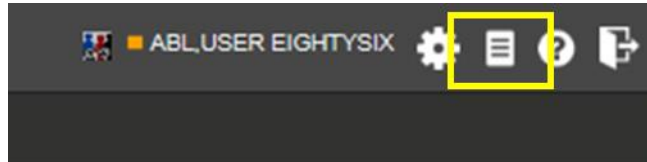

3. The selected records appear in the **Report Builder** window
4. Use the navigation arrows to the right of the listed records ([Figure 41](#)) to arrange the records in the desired order in the generated report. Records can be removed by clicking **Clear Selected Record** or **Clear All**

Figure 41: Report Builder Tools

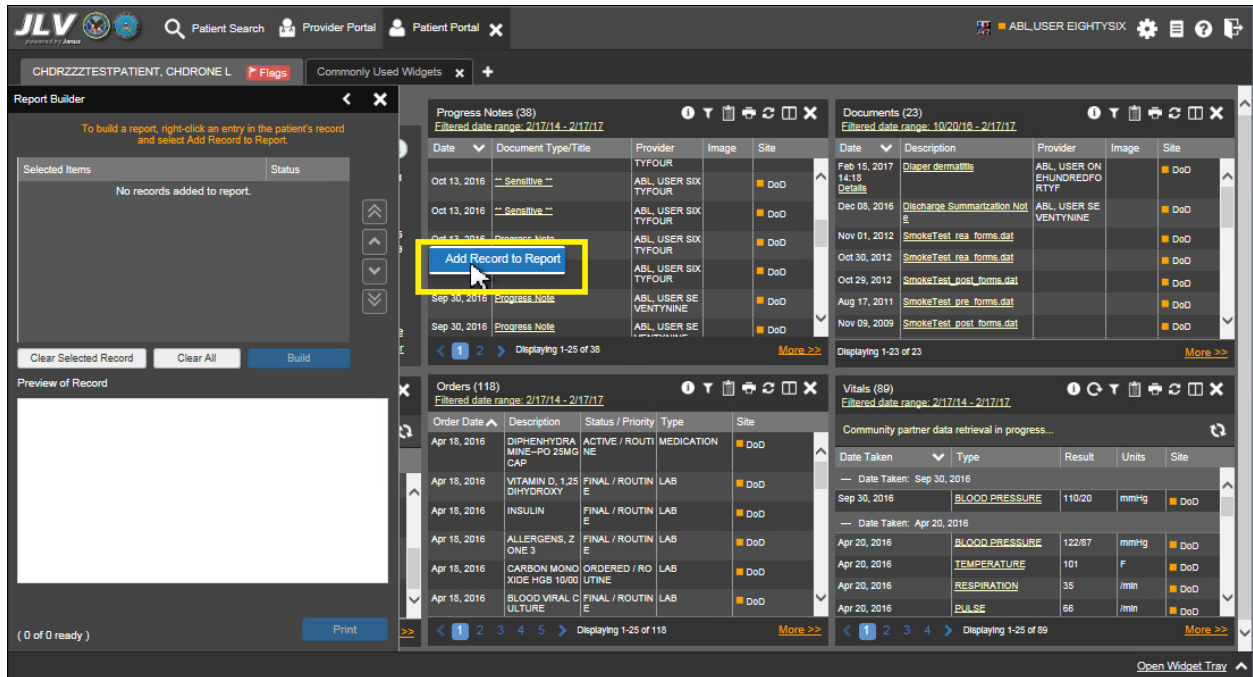
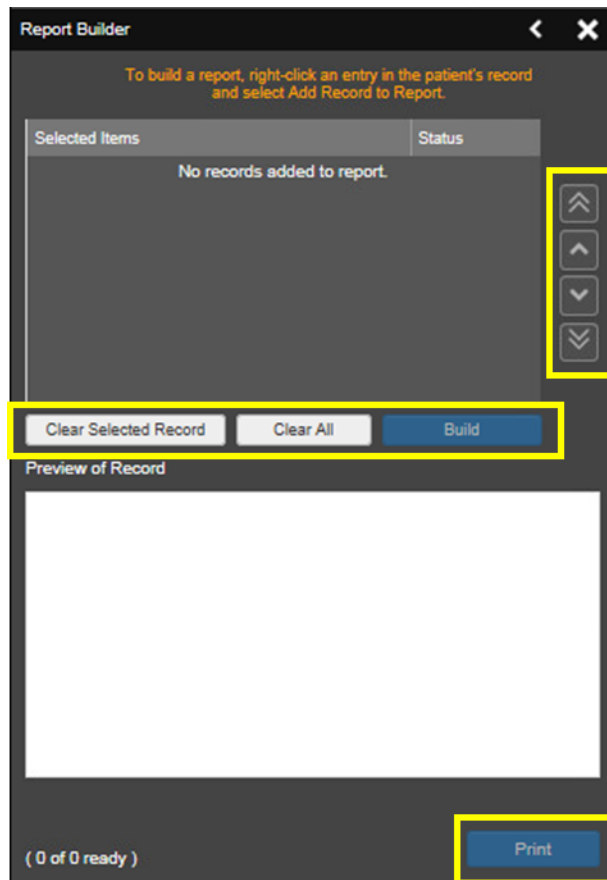

5. When a record is selected for the report, it appears in the **Preview of Record** area of the **Report Builder** window ([Figure 42](#))
6. Click **Build** to validate and prepare the records selected for the report printing. If a record can be added to the report with no errors, there will be a **Ready** notation next to it; if a record cannot be added to the report, there will be an **Error** notation next to it
7. Click **Print** to generate the report, built only with those records that have a **Ready** status

Figure 42 Preview of Record in Report Builder Window

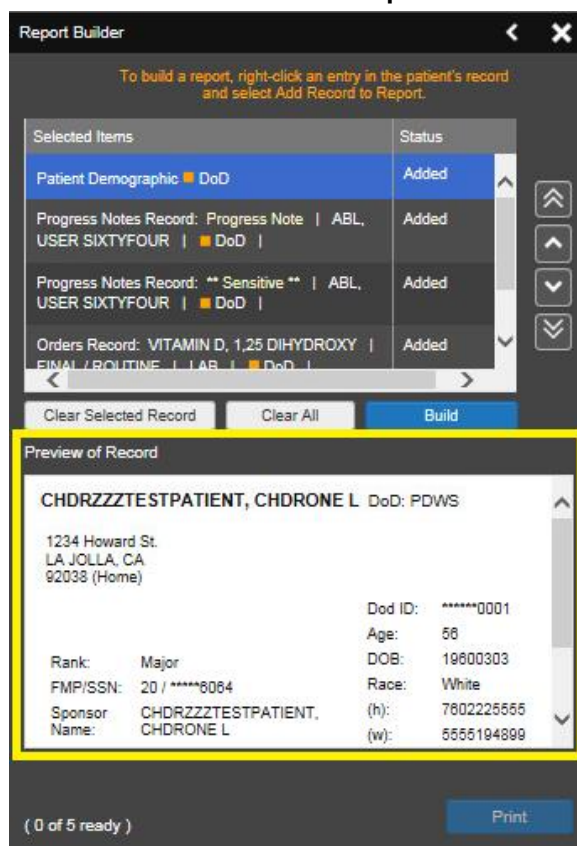

8. The generated report opens in a new tab within the browser window. Save the report to your local system, if desired

Each report generated using the **Report Builder** feature includes this disclaimer:



The information contained in this transmission may contain privileged and confidential information, including patient information protected by federal and state privacy laws. It is intended only for the use of the person(s) named above. If you are not the intended recipient, you are hereby notified that any review, dissemination, distribution, or duplication of this communication is strictly prohibited. If you are not the intended recipient, please contact the sender by reply e-mail, and destroy all copies of the original message.



### 4.3.10. VistA Imaging Viewer

JLV integrates access to the VistA Imaging Viewer (an external application), allowing VA users access to VA imaging artifacts for supported clinical domains (widgets), and DoD radiology exam images. Users can open an instance of the VistA Imaging Viewer through JLV. For more information regarding the VistA Imaging Viewer, please reference the information posted on the [VistA Imaging SharePoint site](#).











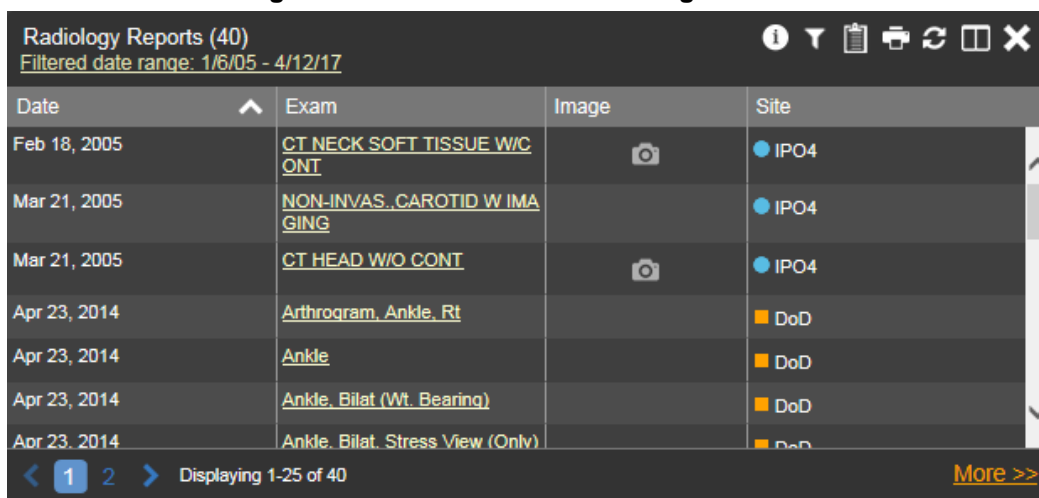

In the **Documents** widget, images not mapped to Text Integration Utility (TIU) documents are displayed as standalone records. Images may be accessed from the **Image** column, but details for the records are not available.

A camera icon  displayed in the **Image** column ([Figure 43](#)) of the **Documents**, **Outpatient Encounters**, **Procedures**, **Progress Notes**, and **Radiology Reports** widgets indicates that one or more images are associated with that record. Clicking the camera icon  within the JLV widget opens the VistA Imaging Viewer in a standalone window, and displays the associated image(s).

**Figure 43: Camera Icon in the Image Column**





Date	Exam	Image	Site
Feb 18, 2005	<a href="#">CT NECK SOFT TISSUE W/CONT</a>		 IPO4
Mar 21, 2005	<a href="#">NON-INVAS. CAROTID W IMAGING</a>		 IPO4
Mar 21, 2005	<a href="#">CT HEAD W/O CONT</a>		 IPO4
Apr 23, 2014	<a href="#">Arthrogram, Ankle, Rt</a>		 DoD
Apr 23, 2014	<a href="#">Ankle</a>		 DoD
Apr 23, 2014	<a href="#">Ankle, Bilat (Wt. Bearing)</a>		 DoD
Apr 23, 2014	<a href="#">Ankle, Bilat. Stress View (Only)</a>		 DoD

If a record has one or more images associated with it, the **Details** view of the widget includes a display of a thumbnail in the top right corner of the window ([Figure 44](#)). Below the thumbnail, a link that reads **Click image to open viewer** is also displayed. Clicking either the thumbnail or the link opens the VistA Imaging Viewer, and display the associated image(s).

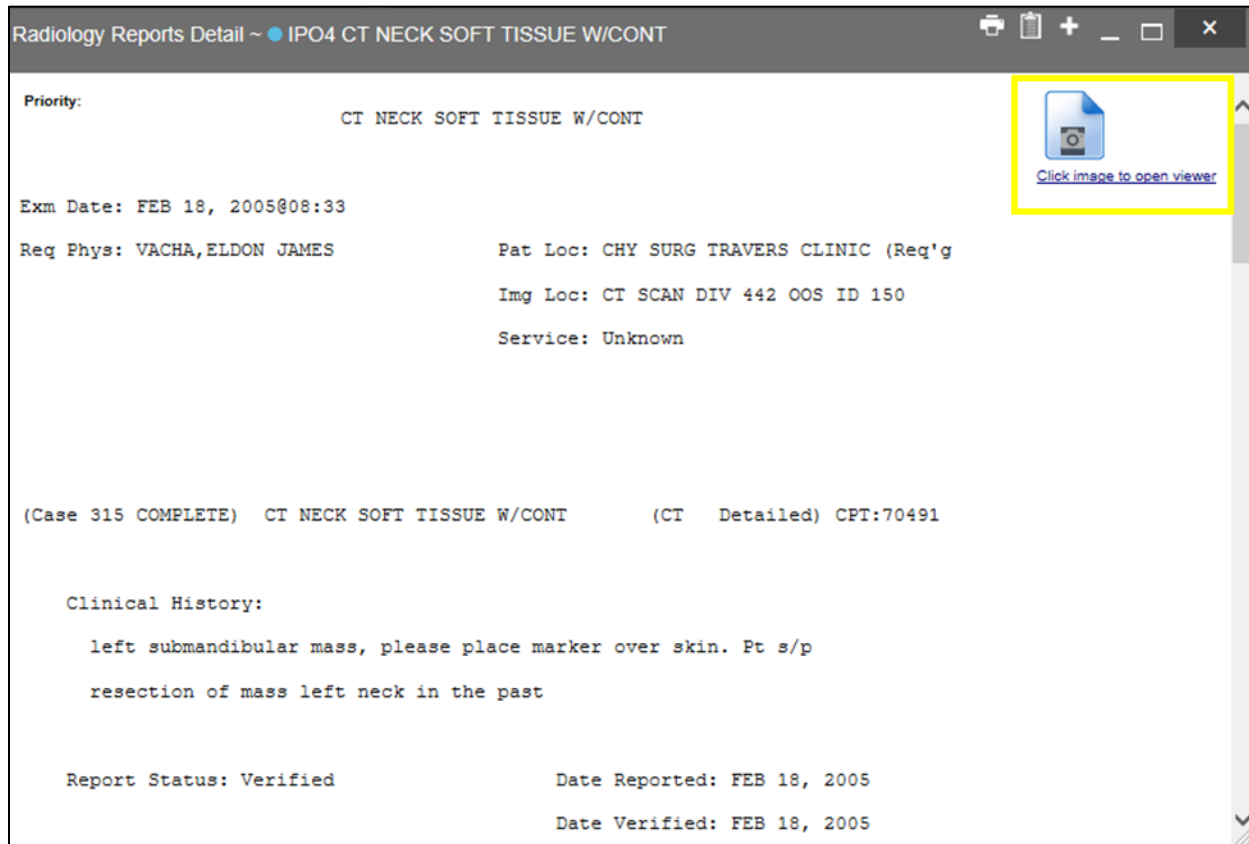
Figure 44: Thumbnail and Link in Details View



## 4.4. Patient Searches

The core function of JLV is to display patient information on the **Patient Portal** . Use the **Patient Search**  feature to search for a patient using DoD ID, SSN, perform a family search, or use advanced search options.



Some users will be restricted to a specific list of patients, and will be unable to use the Search feature. See [Section 4.3.8, User-Restricted Access to Patient Data](#), for more information.

JLV determines which enterprise service to use for a patient search, based upon the search criteria:

- If the EDIPI or Sponsor SSN is entered, JLV utilized PDWS for the search. See [Section 4.4.1, PDWS Search Rules and Supported Searches](#), for details
- If the EDIPI or Sponsor SSN fields are empty, JLV utilizes MVI for the search. See [Section 4.4.2, MVI Search Guidelines](#), for details

#### 4.4.1. PDWS Search Rules and Supported Searches

When PDWS is utilized for patient search, users must adhere to the applicable rules and rule sets required for the PDWS interface:

- Rule Set 1: When searching by SSN, the full nine-digit SSN must be entered, and the Last Name or DOB must also be supplied. This is true for search by patient SSN, as well as Sponsor SSN
- Rule Set 2: If you do not have the SSN, you must supply ALL of the following identifiers: last name, first name, DOB, and gender. Blanks in any of these four required fields will generate an error
- A ten-digit string is required for telephone number

The following search combinations are supported in JLV when PDWS is utilized:

- DoD ID, also referred to as the EDIPI
- Patient SSN and Last Name
- Patient SSN and Date of Birth (DOB)
- Sponsor SSN and Last Name
- Sponsor SSN and DOB
- Last Name, First Name, DOB, and Gender (ALL identifiers must be entered)

#### 4.4.2. MVI Search Guidelines

When a VA user searches for patient records using a patient's SSN and name, JLV utilizes MVI for the search. MVI requires the full last name when the patient's SSN is entered. The MVI may also require entering the patient's first name and DOB to increase the efficiency of the search and the likelihood of locating the patient. An example would be searching for a patient with a common last name, such as Smith or Jones.

#### 4.4.3. Patient Search Using DoD ID

To perform a patient search using the DoD ID ([Figure 45](#)):

1. Click the **Patient Search** icon  at the top of the portal page. The Patient Search dialog opens
2. Enter the eleven-digit patient DoD ID (EDIPI) in the **DoD ID** field

**Figure 45: Patient Search Using DoD ID**

The screenshot shows a 'Patient Search' dialog box with the following fields and options:

- DoD ID:** 1606681433 (highlighted with a yellow border)
- OR**
- SSN:** Please Enter Patient SSN
- OR Sponsor SSN:** Please Enter Sponsor SSN
- \* Last Name:** [Empty field]
- First Name:** [Empty field]
- [<< Show Advanced Search Options](#)
- \* When searching by SSN, Last Name or DOB is required.**
- Search** button

Below the search fields, there are two tabs: 'Recently Viewed Patients' and 'Search Results'. The 'Search Results' tab is active, displaying a table with the following data:

Name	DoD ID	SSN	Date of Birth	Gender
IPOAADLAND, THADDEUS A	1606681433	101936540	19441023	M

3. Click **Search**. The search results are displayed in the lower third of the dialog box, under the **Search Results** tab
4. Click a patient's name in the search results list to open the associated record. The Name, SSN, DOB, and Gender columns in the results list provide information to assist with patient identification
5. After selecting a patient, the **Patient Portal**  displays the selected patient's data

#### 4.4.4. Patient Search Using SSN

To perform a patient search using the patient's SSN:

1. Click the **Patient Search** icon  at the top of the portal page. The Patient Search dialog box opens
2. Enter the patient's full, nine-digit SSN in the **SSN** field ([Figure 46](#))



**NOTE:** When searching by SSN, either the last name or the DOB must be entered to perform the search.

**Figure 46: Patient Search Using Patient's SSN**

The screenshot shows a 'Patient Search' dialog box with the following fields and values:

- DoD ID: Please Enter Patient DoD ID
- OR
- SSN: 101-93-6540
- OR Sponsor SSN: Please Enter Sponsor SSN
- \* Last Name: IPOAADLAND (highlighted with a yellow box)
- First Name: (empty)
- << Show Advanced Search Options
- \* When searching by SSN, Last Name or DOB is required.
- Search button

Below the search fields, there are two tabs: 'Recently Viewed Patients' and 'Search Results'. The 'Search Results' tab is active, displaying a table with the following data:

Name	SSN	Date of Birth	Gender
IPOAADLAND, THADDEUS A	101936540	19441023	M

3. Click **Search**. If the required patient identifiers are not provided, hover text appears indicating the information necessary to complete the patient search. If a match of patient names cannot be made, enter more identifiers to refine the search
4. The search results are displayed in the lower third of the dialog box, under the **Search Results** tab
5. Click a patient's name in the **Search Results** list to open the associated record. The Name, SSN, DOB, and Gender columns in the results list provide information to assist with patient identification
6. After selecting a patient, the **Patient Portal**  displays the selected patient's data

#### **4.4.5. Advanced Patient Search Options**

Advanced patient search options in the **Patient Search** dialog box allow for the use of additional patient identifiers when searching for a patient.

To perform a patient search using advanced options:

1. Click the **Patient Search** icon  at the top of the portal page. The Patient Search dialog box opens
2. Click the <<**Show Advanced Search Options** link under the \***Last Name** field ([Figure 47](#))
3. Enter the patient identifiers in the appropriate search fields, as desired. Advanced search option fields include \***DOB**, **Middle Initial (MI)**, **Gender**, **Address**, **State**, **City**, **Zip**, and **Telephone**

**Figure 47: Advanced Patient Search Options**

The screenshot shows a 'Patient Search' dialog box with the following fields and options:

- DoD ID: [Text Input]
- OR
- SSN: [Text Input: Please Enter Patient SSN] OR Sponsor SSN: [Text Input: Please Enter Sponsor SSN]
- \* Last Name: [Text Input] First Name: [Text Input]
- >> Hide Advanced Search Options
- \* DOB: [Text Input: YYYYMMDD] MI: [Text Input] Gender: [Select]
- Address: [Text Input] State: [Select] Zip: [Text Input]
- City: [Text Input] Telephone: [Text Input]
- \* When searching by SSN, Last Name or DOB is required.
- [Search Button]
- Recently Viewed Patients | Search Results

Name	DoD ID	SSN	Date of Birth	Gender
[Empty Table]				

4. Click **Search**. If the required patient identifiers are not provided, hover text appears indicating the information necessary to complete the patient search
5. The search results are displayed in the lower third of the dialog box, under the **Search Results** tab
6. Click a patient's name in the **Search Results** list to open the associated record. The Name, SSN, DOB, and Gender columns in the results list provide information to assist with patient identification
7. After selecting a patient, the **Patient Portal**  displays the selected patient's data

#### **4.4.6. Family Member Search**

JLV's functionality allows a user to perform a family member search using the **Sponsor SSN** field in the Patient Search dialog box.

To perform a family member search:

1. Click the **Patient Search** icon  at the top of the portal page. The Patient Search dialog box opens
2. Enter the SSN in the **Sponsor SSN** field. The **Last Name** or **DOB** of the patient must also be entered in the appropriate fields ([Figure 48](#))
3. Click **Search**. If the required patient identifiers are not provided, hover text appears indicating the information necessary to complete the patient search

- The search results are displayed in the lower third of the dialog box, under the **Search Results** tab ([Figure 48](#))

**Figure 48: Patient Search Using Sponsor SSN**

The screenshot shows a 'Patient Search' dialog box with the following fields and values:

- DoD ID: Please Enter Patient DoD ID
- OR
- SSN: Please Enter Patient SSN
- OR Sponsor SSN: 666-46-0945
- \* Last Name: Phillips
- First Name: (empty)
- << Show Advanced Search Options
- \* When searching by SSN, Last Name or DOB is required.
- Search button

Below the search fields, there are two tabs: 'Recently Viewed Patients' and 'Search Results'. The 'Search Results' tab is active, displaying a table with the following data:

Name	SSN	Date of Birth	Gender
Pierce, Ruth M	666460945	19880422	F

- Click a name in the **Search Results** list. The **Family Members** dialog opens ([Figure 49](#)). The sponsor's identifiers and a list of dependents are displayed in the dialog
- Click a name in the list of family members to open the associated record
- After selecting a patient, the **Patient Portal**  displays the selected patient's data

**Figure 49: Family Members Dialog**

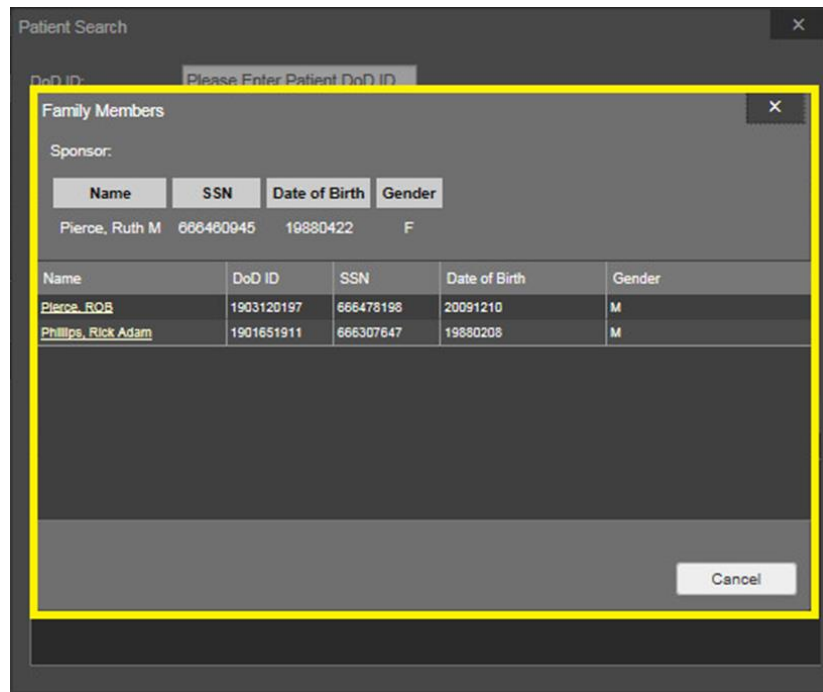



#### 4.4.7. Recently Viewed Patients List

Users who have previously logged into JLV, searched for a patient, and viewed that patient's records, can see and access a list of recently viewed patients. A recent patient is defined as a patient whose record has been viewed (opened) by the user.



**NOTE:** The **Recently Viewed Patients** list does not include search history or recent search results, only a list of patients whose data was accessed/viewed. The list is limited to ten (10) patients.

To open the list of recently viewed patients:

1. Click the **Patient Search** icon  at the top of the portal page. The Patient Search dialog opens
2. Click the **Recently Viewed Patients** tab in the lower third of the Patient Search dialog
3. A list of recently viewed patients is displayed ([Figure 50](#)). The Name, DoD ID, SSN, DOB, and Gender columns in the results list provide information to assist with patient identification
4. Click a patient's name in the **Recently Viewed Patients** list to open the associated record
5. After selecting a patient, the **Patient Portal**  displays the selected patient's data



**Figure 50: Recently Viewed Patients List**

The screenshot shows a 'Patient Search' window with the following search criteria:

- DoD ID: [Empty field]
- OR
- SSN: Please Enter Patient SSN OR Sponsor SSN: Please Enter Sponsor SSN
- \* Last Name: [Empty field] First Name: [Empty field]
- << Show Advanced Search Options
- \* When searching by SSN, Last Name or DOB is required.
- Search button

Below the search criteria is a table titled 'Recently Viewed Patients' with the following data:

Name	DoD ID	SSN	Date of Birth	Gender
<a href="#">IPOAADLAND_THADDEUS A</a>	1606681433	101936540	19441023	M
<a href="#">IPOASIF_DARRIN L</a>	1606681786	101306999	19230918	M
<a href="#">CHDRZZZTESTPATIENT_CHDRONE L</a>	1666000001	666000001	19600303	M
<a href="#">ZZZRETSIXTHIRTYFOUR_PATIENT</a>	1900276273	666555334	20030121	F
<a href="#">EIGHT_PATIENT</a>	1900258226	666000008	20030121	F
<a href="#">ZZZRETIREDZERO_PATIENT</a>	1900241255	666965487	20030121	F
<a href="#">EIGHT_OUTPATIENT</a>	1901053315	666000608	20030121	F
<a href="#">ZZZRETIREDFIFTYSEVEN_PATIENT</a>	1901840626	666693256	20030121	F
<a href="#">EIGHT_INPATIENT</a>	1902242731	666000808	20030121	F

## 4.5. Widget Functionality

The following subsections detail the functionality in a sampling of the widgets available in JLV.



### 4.5.1. Patient Demographics

The **Patient Demographics** widget displays a summary of the patient's non-clinical or personal data. The widget appears in the upper left section of the Patient Portal ([Figure 51](#)). The tabs above the patient's name provide the patient's demographics summary for each site (VA, DoD, or VLER) the patient has visited.

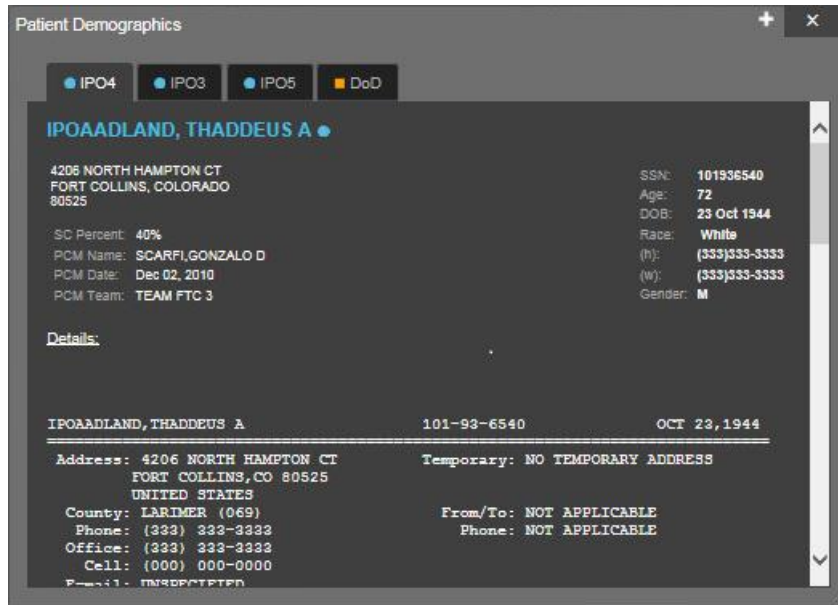
**Figure 51: Patient Demographics on the Patient Portal**



The **Demographics** widget provides additional functionality and displays:

- Clicking the patient's name opens patient demographics details in a separate window
- Clicking an **Interface Status** icon   opens the interface status details in a separate window
- Clicking the **Flags** icon above the tabs in the widget opens clinical flag details in a separate window

#### 4.5.1.1. Race Data Terminology Normalization

Race data from DoD and VA sources appearing in the **Demographics** widget is normalized. Hovering over the **Race** field will display the standardized name and code for the race classification, normalized to the Centers for Disease Control (CDC) standard.

**Figure 52: Standardized Race Data in the Demographics Widget**

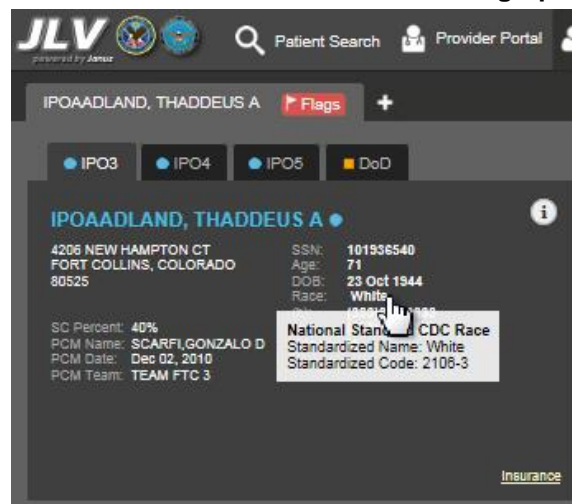

#### 4.5.1.2. Demographics from Community Partners

When users enable the **Include Community Data** setting and VLER patient data is returned to JLV, the **Demographics** widget displays color-coded information.

- The blue circle represents data retrieved from a VA system
- The orange square represents data retrieved from a DoD system
- The purple hexagon represents data retrieved from VLER sources



When insurance data is provided by a community partner, an **Insurance** link for that partner is provided in the patient demographics window. The link opens a new window with insurance information.

#### 4.5.1.3. Viewing Third-Party Insurance Information

Third-party payers and additional insurance information are available from the **Demographics** widget. Click **Insurance** in the **Demographics** widget. A new window ([Figure 53](#)) opens with the following insurance information:

- Health Plan Type
- Health Plan Name
- Standardized Insurance Type
- Plan Effective Date
- Plan Expiration Date
- Site
- Group Number
- Member ID
- Subscriber ID
- Subscriber Date of Birth
- Subscriber's Relationship to Insurer
- Health Plan Mailing Address
- Health Plan Contact Information

**Figure 53: Insurance Information**

Health Plan Type	Health Plan Name	Standardized Insurance Type	Plan Effective Date	Plan Expiration Date	Site	Group Number	Member ID
COMPREHENSIVE MAJOR MEDICAL	UNITED HEALTHCARE	Private Health Insurance - Indemnity	Jan 19, 2015		IPO3	GRP NUM 14533	
MEDICARE (M)	MEDICARE (WNR)	Medicare	Sep 01, 2009		IPO4	GRP NUM 9232	
MEDICARE (M)	MEDICARE (WNR)	Medicare	Sep 01, 2009		IPO4	GRP NUM 9303	
MEDIGAP PLAN C	MUTUAL OF OMAHA	Medicare Supplemental policy (as second payer)	Sep 01, 2009		IPO4	GRP NUM 13129	
MEDICARE (M)	MEDICARE (WNR)	Medicare	Sep 01, 2009		IPO3	GRP NUM 9232	
MEDICARE (M)	MEDICARE (WNR)	Medicare	Sep 01, 2009		IPO3	GRP NUM 9303	
MEDIGAP PLAN C	MUTUAL OF OMAHA	Medicare Supplemental policy (as second payer)	Sep 01, 2009		IPO3	GRP NUM 13129	

Displaying 1-7 of 7

Use the scroll bar in the window to view additional columns not seen within the default window size.

The data in the **Standardized Insurance Type** column is normalized to the X12 Health Insurance Type standard. Hovering over entries in this column display the standardized name and code for the insurance type.

#### 4.5.2. Allergies

The **Allergies**  widget displays a patient's allergy information ([Figure 54](#)). There is no allergy information available from TMDS at this time, as seen in the red banner display across the widget.

**Figure 54: Allergies Widget**

Date Recorded	Allergen	Standardized Allergen	Reaction	Severity	Comments	Site
Oct 07, 2013	ALLIPOIC ACID/ENZYMES/EMULSIFIERS (ALLIPOIC ACID/ENZYMES)		Unknown			DoD
Jan 17, 2014	ACETASOL		Unknown			DoD
Jan 17, 2014	ACETASOL		Unknown			DoD
Jan 17, 2014	ACETASOL		Unknown			DoD
Jan 17, 2014	ACETATE SALT		Unknown			DoD
Jan 17, 2014	ACETIC ACID		Unknown			DoD
Jan 17, 2014	ACETIC ACID GLACIAL AR		Unknown			DoD
Jan 17, 2014	ADHESIVE BANDAGE/TAPE/EMULSIFIERS		Unknown			DoD
Jan 17, 2014	ALPROSTADIL		Unknown			DoD
Jan 17, 2014	ALPROSTADIL		Unknown			DoD
Jan 17, 2014	ALUMINUM		Unknown			DoD
Jan 17, 2014	ALUMINUM		Unknown			DoD
Jan 17, 2014	ALUMINUM		Unknown			DoD
Dec 11, 2013	ALUMINUM (DO NOT USE, NOT SCREENED)		Rash			DoD

#### 4.5.2.1. Allergies Widget Data

Information in the minimized view of the Allergies widget ([Figure 55](#)) includes:

- Date Recorded
- Allergen
- Site

Click a column title to sort records by that column. If sorting is used on a column that appears in both the minimized and expanded views of the widget, the sort will be saved in the user profile and will be seen in the next JLV session. If sorting is used on a column that is only available in the expanded view of the widget, the next JLV session will restore the default widget sort, unless or the last sort saved to the user profile.

**Figure 55: Allergies Widget, Minimized View**

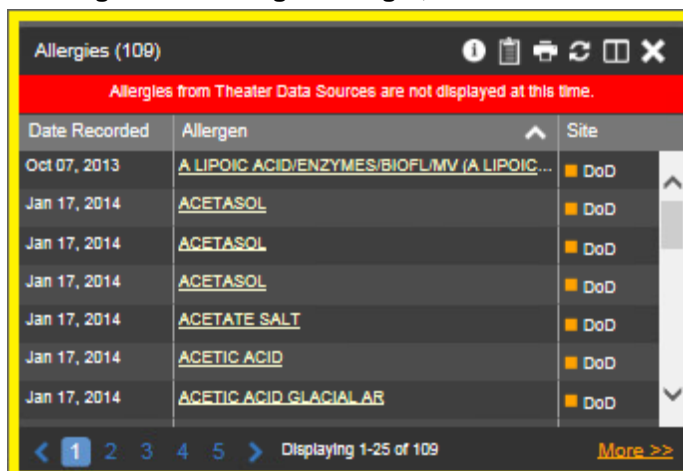

Click **More >>** in the minimized view of the **Allergies** widget to open the expanded view. Information in the expanded view includes:

- Date Recorded
- Allergen
- Standardized Allergen
- Reaction
- Severity
- Comments
- Site

#### 4.5.2.2. Viewing Allergy Details

Clicking a hyperlinked entry in the **Allergen** column in either the minimized or expanded view of the **Allergies** widget opens a separate window that displays the details of the allergy record. The presentation of data within the secondary window differs slightly, depending on whether the record is a VA or DoD record.

[Figure 56](#) presents the details view for a DoD record.

**Figure 56: Allergy Details View**

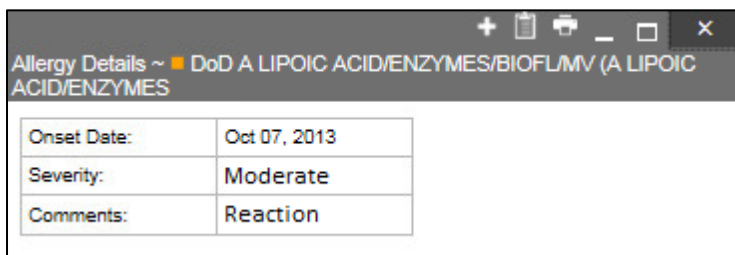



- Date
- Document
- Source

The purple hexagon beside entries in the **Source** column denotes the source of that data is outside the VA.

**Figure 58: Community Health Summaries and Documents – VA, Minimized View**

Date	Document	Source
Nov 04, 2016	<a href="#">Summarization of episod...</a>	MedVirginia
Dec 03, 2014	<a href="#">Continuity of Care CCDA...</a>	Wright State
Dec 04, 2014	<a href="#">C62 Pathology 27898-6</a>	MedVirginia
Mar 03, 2013	<a href="#">C62 Consults 11488-4</a>	Wright State
Jan 01, 2005	<a href="#">C32 Summarization of ep...</a>	MedVirginia

Displaying 1-5 of 5

The **Site List** icon  on the toolbar in the **Community Health Summaries and Documents - VA** widget ([Figure 58](#)) is used to view only the list of community sites where the patient has been seen.

After clicking the **Site List** icon, the widget refreshes and displays the full list of community sites where the patient was seen, gathered from the **Source** column. Community sites listed in the record where the patient was seen, but no document was generated for the visit, will also be displayed. Click **Close Site List** to remove the full site list from the widget display.

#### 4.5.3.2. Viewing VA Community Health Summary Documents

[Figure 58](#) shows health summary records available from the **Document** column in the **Community Health Summaries and Documents - VA** widget. Clicking a hyperlinked entry in the **Document** column opens the document in a separate browser tab ([Figure 59](#)).



Multiple documents can be opened in separate browser tabs for viewing simultaneously.



Figure 59: Community Health Document

JLV - Wright State : C62 Consults 11488-4 - Internet Explorer

**Department of Veterans Affairs**

**Consultation note**

Created On: November 10, 2013

<b>Patient:</b>	VANCE EUGENE IPOABOOD	<b>Patient ID:</b>	1012740031V036697
<b>Birthdate:</b>	November 3, 1948	<b>Sex:</b>	M
<b>Source:</b>	GREELEY CBOC Author: SANFORD C LOCKLIN GEOFFREY C. RYDER, M.D.		

**Table of Contents**

**Attached File**

LOCAL TITLE: PSYCHIATRY CONSULT REPORT  
STANDARD TITLE: PSYCHIATRY CONSULT  
DATE OF NOTE: NOV 03, 2013@14:34      ENTRY DATE: NOV 04, 2013@09:44:45  
AUTHOR: LOCKLIN,SANFORD C      EXP COSIGNER:  
URGENCY:      STATUS: COMPLETED

Maddera, Robert

Date/time: The pt was scheduled for a 1 hour initial consultation at 1300 on 3 November 2005 at CBOC Greeley; was seen from then until 1405.

IDENTIFICATION: This is a 57 y/o divorced NSC white male, retired, referred by Dr. Holland because of transferring from psychiatric care at VAMC Grand Junction. We note that today is the pt's birthday.

CHIEF COMPLAINT: "I have trouble sleeping and I take a drink."

HPI: Reference is made to the entries of Dr. France at VAMC Grand Junction,

75%

#### 4.5.4. Documents

The **Documents**  widget ([Figure 60](#)) includes documents from multiple clinical domains, including radiology reports (exams), progress notes, outpatient encounters, consult encounters, discharge summaries (inpatient notes), questionnaires, and Health Artifact and Image Management Solution (HAIMS) records. HAIMS records retrieved by JLV include scanned paper records, imported paper records, scanned non-radiology images, and imported non-radiology images, displayed in chronological order by the document date.

**Figure 60: Documents Widget, Minimized View**

Date	Description	Provider	Image	Site
Feb 15, 2017 14:18 <a href="#">Details</a>	<a href="#">Diaper dermatitis</a>	ABL, USER ON EHUNDREDFO RTYF		DoD
Dec 08, 2016	<a href="#">Discharge Summarization Note</a>	ABL, USER SE VENTYNINE		DoD
Nov 01, 2012	<a href="#">SmokeTest_rea_forms.dat</a>			DoD
Oct 30, 2012	<a href="#">SmokeTest_rea_forms.dat</a>			DoD
Oct 29, 2012	<a href="#">SmokeTest_post_forms.dat</a>			DoD
Aug 17, 2011	<a href="#">SmokeTest_pre_forms.dat</a>			DoD
Nov 09, 2009	<a href="#">SmokeTest_post_forms.dat</a>			DoD

Displaying 1-23 of 23 [More >>](#)

#### 4.5.4.1. Documents Widget Data

The minimized view of the **Documents** widget provides the following information:

- Date
- Description
- Provider
- Image
- Site

Outpatient encounter records displayed in the **Documents** widget may have a **Details** link enabled in the **Date** column. Where available, click the link to open a **Details** window for records of this type.

The **Description** column displays the document title, where available. Click a hyperlinked entry in the **Description** column in either the minimized or expanded view of the widget to open the document.

A **camera** icon  in the **Image** column of the **Documents** widget indicates that one or more images are associated with that record. Clicking the **camera** icon opens the VistA Imaging Viewer in a standalone window, and displays the associated image(s).

Click **More >>** in the minimized view of the **Documents** widget to open the expanded view ([Figure 61](#)). Information in expanded view includes:

- Date
- Description
- Standardized Description
- Provider
- Provider Specialty
- Location
- Status
- Site

**Figure 61: Documents Widget, Expanded View**

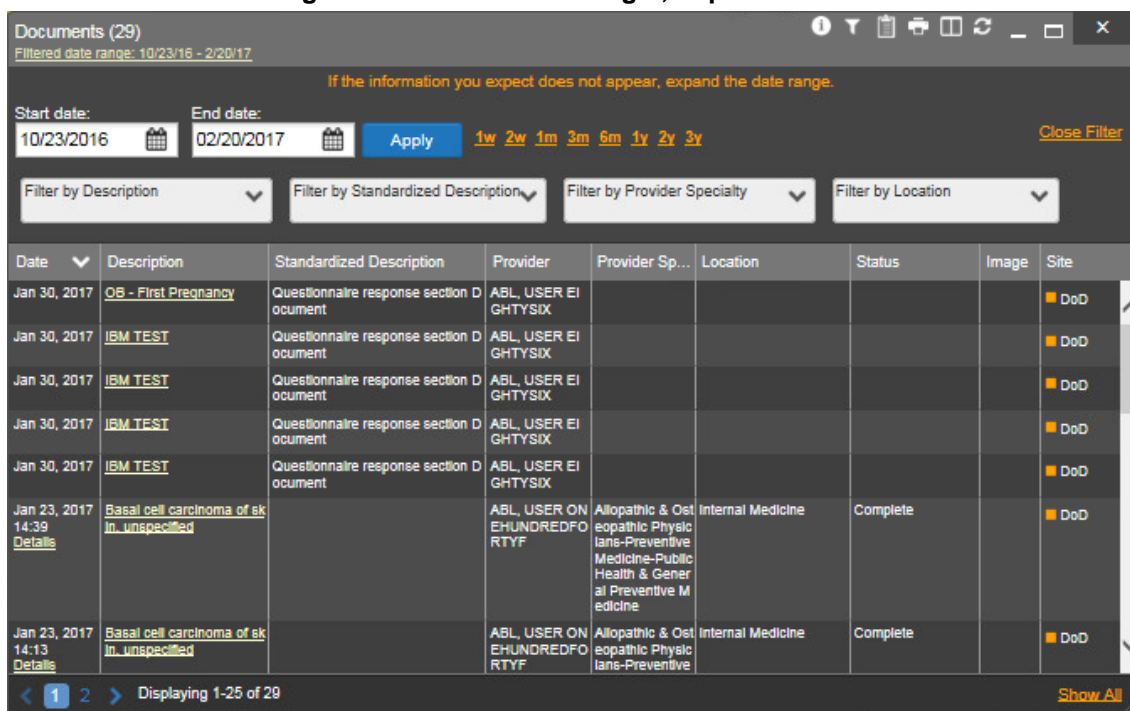

#### 4.5.4.2. Viewing Documents

Click a hyperlinked entry in the **Description** column in either the minimized or expanded views of the **Documents** widget to access additional information for a listed record. Depending on the record type, the additional information may open in either a details window or a separate browser window. [Figure 62](#) displays outpatient encounters details, accessed through the **Documents** widget.

**Figure 62: Details of a Document Record**

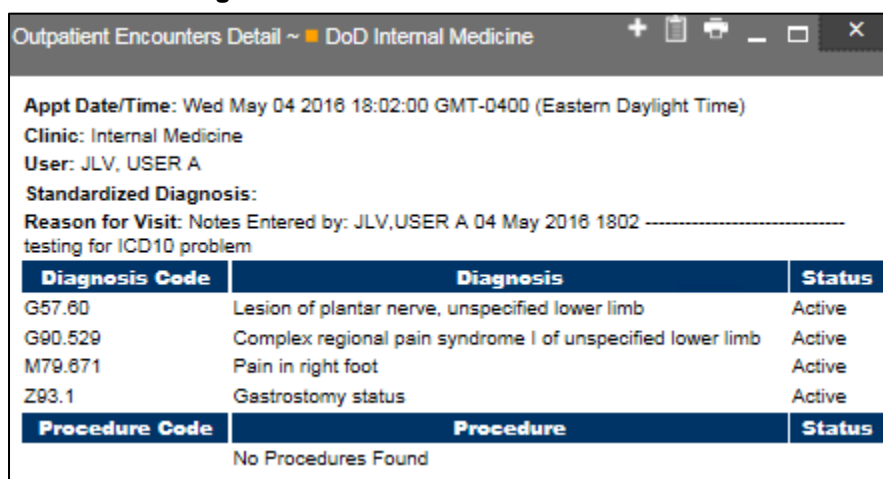

#### 4.5.4.3. Viewing DoD Sensitive Data

JLV masks the display of sensitive records in the **Documents** widget. The record is masked with the tag **\*\* Sensitive\*\***. A user may view the data, but the action is audited (recorded) each time a sensitive DoD record is viewed.

After clicking the hyperlink in the **Description** column for a sensitive record, JLV notifies the user that they will be audited ([Figure 35](#)). This message is triggered each time a user clicks a sensitive record. After the user selects the purpose of viewing the record and agrees to be audited, the sensitive data appears in the **Details** view, but the record remains masked in the minimized and expanded views of the widget.

#### 4.5.4.4. Display and Filter Options

Display and filter options within the **Documents** widget include:

- Click a column title to sort records by that column. If a user sorts on a column that appears in both minimized and expanded views of the widget, the sort will be saved in the user profile and will appear in the next JLV session. If a user sorts on a column that is only in the expanded view of the widget, the next JLV session will restore the default widget sort, or the last sort saved to the user profile.
- Use the **Quick Date Range Selector**, or the **Start Date** and **End Date** calendars to specify the date range of records to be displayed within the widget. If the information you expect does not appear in the widget display, use the **Start Date** and **End Date** filter options to expand the date range. When a date range filter is applied in an open widget, the date range is displayed in the widget header. Open or close the filter options by clicking the date range in the header.
- Click the **Column Settings** icon  in the widget toolbar to show or hide the columns within the widget. Check/uncheck the column names that appear in the pop-up dialog, then click **Apply**.
- Use the **Filter by Description** dropdown to re-draw the widget to show only the records for the selected description(s). Only available in expanded view.
- Use the **Filter by Standardized Description** dropdown to re-draw the widget to show only the records for the selected description(s). Only available in expanded view.
- Use the **Filter by Provider Specialty** dropdown to re-draw the widget to show only the records for the selected provider type(s). Only available in expanded view.
- Use the **Filter by Location** dropdown to re-draw the widget to show only the records for the selected location(s). Only available in expanded view.

#### 4.5.4.5. Terminology Normalization

Terminology normalization is provided in the **Documents** widget through the following GUI elements:

- The **Description** column displays the name of a note or document within the patient's record. Hovering over an entry in this column displays the standard used for terminology normalization for the clinical domain (Logical Observation Identifiers Names and Codes (LOINC)), and the standardized LOINC name and code for that document.

- The **Standardized Description** column displays the standardized name for the corresponding entry in the **Description** column, mapped to the LOINC standard. In addition to the standardized name, hovering over an entry in this column displays the standard used for terminology normalization for the clinical domain (LOINC), and the standardized code for that document.
- The data in the **Provider and Provider Specialty** columns, in both the minimized and expanded views of the widget, are normalized to the National Uniform Claim Committee Taxonomy (NUCC) standard. Hovering over entries in these columns displays the standardized name and code for the provider.

[Figure 63](#) highlights a document mapped to the LOINC standard. The standardized name and code are displayed in the hover text over the record in the **Description** column.

**Figure 63: Terminology Normalization – Documents Widget**

The screenshot shows a web interface for a 'Documents (29)' widget. It includes a date filter (4/13/2016 to 8/11/2016), filter buttons for Description, Standardized Description, Provider Specialty, and Location, and a table of records. A tooltip is shown over the 'Standardized Description' column for the record dated Jun 07, 2016, displaying 'Logical Observation Identifiers Names and Codes (LOINC)' and 'Standardized Name: Restraint note' and 'Standardized Code: 70007-0'.

Date	Description	Standardized Description	Provider	Provider Sp...	Location	Status	Image	Site
Jul 28, 2016 12:58 <a href="#">Details</a>	No diagnosis available.		TTS,NURSE TUI	Nursing Service Providers	CHY CHEYENNE MEDICAL SPEC			• IPO4
Jul 28, 2016	10-10.MEDICAL PROGRESS NOTE		TTS,NURSE TUI	Nursing Service Providers	CHYSQA260			• IPO4
Jun 07, 2016	NURSING ONE ONE ONE 0000-07	Restraint note	ROBERTS,J... M	Allopathic and Osteopathic Physicians	CHYSQA260			• IPO4
Jun 07 13:16 <a href="#">Details</a>	Logical Observation Identifiers Names and Codes (LOINC) Standardized Name: Restraint note Standardized Code: 70007-0		ROBERTS,J... M	Allopathic and Osteopathic Physicians	CHY ANTICOAG			• IPO4
Jun 06			ROBERTS,J... M	Allopathic and Osteopathic Physicians	CHEYENNE VAMC			• IPO4
Jun 06, 2016 12:06 <a href="#">Details</a>	No diagnosis available.		ROBERTS,J... M	Allopathic and Osteopathic Physicians	CHY CPL GENERAL INPATIENT			• IPO4
May 04, 2016 18:02 <a href="#">Details</a>	Lesion of plantar nerve, unspecified lower limb		JLV, USER A	Allopathic & Osteopathic Physicians :	Internal Medicine	Complete		■ DoD

## 4.5.5. Military Health System (MHS) GENESIS

The MHS GENESIS widget displays documents within the patient’s record from MHS GENESIS. The information is displayed in reverse chronological order by date.

### 4.5.5.1. MHS GENESIS Widget Data

In the minimized view of the MHS GENESIS widget, the orders information includes:

- Date
- Document Title

- Document Type
- Site

[Figure 64](#) highlights the MHS GENESIS widget in minimized view.

Medical Continuity of Care documents (CCD), Dental CCD, and Aggregate CCDs with blank entries in the **Date** column for the record appear first in the widget by default.

**Figure 64: MHS GENESIS Widget, Minimized View**

MHS GENESIS (2)			
Date	Document Title	Document...	Site
Sep 13, 2016	<a href="#">Aggregated CCD</a>	Summary of Episode Note	DoD
Aug 31, 2016	<a href="#">- Transition of Care - Referral Summary for JAMES RYAN</a>	Transition of Care - Referral Summary	DoD

Displaying 1-2 of 2

#### 4.5.5.2. Viewing MHS GENESIS Documents

Click a hyperlink in the **Document** column in either view of the MHS GENESIS widget to open a separate window that displays a Consolidated Clinical Document Architecture (CCDA) document ([Figure 65](#)).

Figure 65: CCDA Document Display

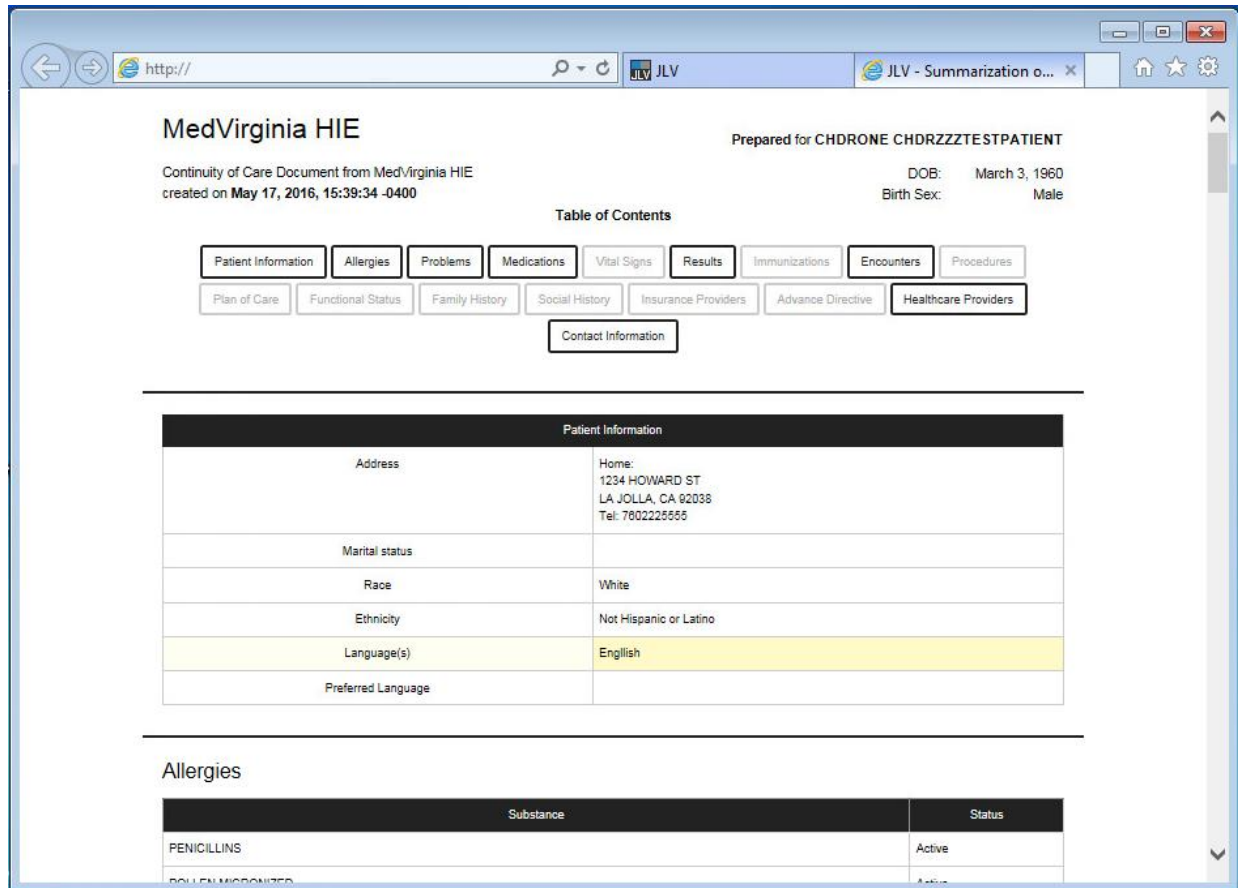

## 4.5.6. Outpatient Encounters

The **Outpatient Encounters**  widget ([Figure 66](#)) includes clinical data for outpatient encounters.

### 4.5.6.1. Outpatient Encounters Widget Data

Information in the minimized view of the Outpatient Encounters widget includes:

- Encounter Date
- Clinic
- Provider
- Diagnosis
- Image
- Site

Click **More >>** in the minimized view of the **Outpatient Encounters** widget to open the expanded view of the widget. In the expanded view, the outpatient encounter information includes:

- Encounter Date
- Clinic
- Status
- Type
- Provider
- Provider Specialty
- Reason
- Diagnosis
- Standardized Diagnosis
- Image
- Site

Figure 66: Outpatient Encounters Widget, Expanded View

Encounter Date	Clinic	Status	Type	Provider	Provider Specialty	Reason	Diagnosis	Standardized Diagnosis	Image	Site
May 04, 2016 2:04 <a href="#">Details</a> <a href="#">Note</a>	CHY PC DE RMATOLOG Y		OFFICE/OUT PATIENT VIS IT EST	BODDULUR I,PADMA	Allopathic and Osteopathic Physicians					IPO 3
Apr 22, 2016 12:36 <a href="#">Details</a> <a href="#">Note</a>	Internal Medi cine	Complete	OUTPATIEN T	ABL, USER ONE	Allopathic & Osteopathic Ph ysicians-Family Medicine-	Notes Entered by: ABL,USER ONE 22 Apr 20 16 1236 ----- smoke with CA C	Gout, unspecif ed			DoD
Apr 11, 2016 16:40 <a href="#">Details</a> <a href="#">Note</a>	Internal Medi cine	Complete	OUTPATIEN T	ABL, USER ONE	Allopathic & Osteopathic Ph ysicians-Family Medicine-	Notes Entered by: ABL,USER ONE 11 Apr 20 16 1640 ----- smoke test - an other patient!	Pain in thoracic spine			DoD
Feb 10, 2016 15:00 <a href="#">Details</a> <a href="#">Note</a>	CHY ANTIC OAG		CHY ANTIC OAG VISIT							IPO 3
Jul 15, 2015 10:50	C MEDICINE		HOSPITALIZ ATION	MYERS,ANG E L A M	Allopathic and Osteopathic Physicians					IPO

#### 4.5.6.2. Viewing Outpatient Encounter Details

Click the **Details** hyperlink, where available, in the **Encounter Date** column of either view of the **Outpatient Encounters** widget. A separate window opens, displaying the details of the encounter ([Figure 67](#)).

When a record contains one or more images, the **Details** view accessed from the widget displays a thumbnail in the top right corner of the window.



Figure 67: Outpatient Encounters, Details View

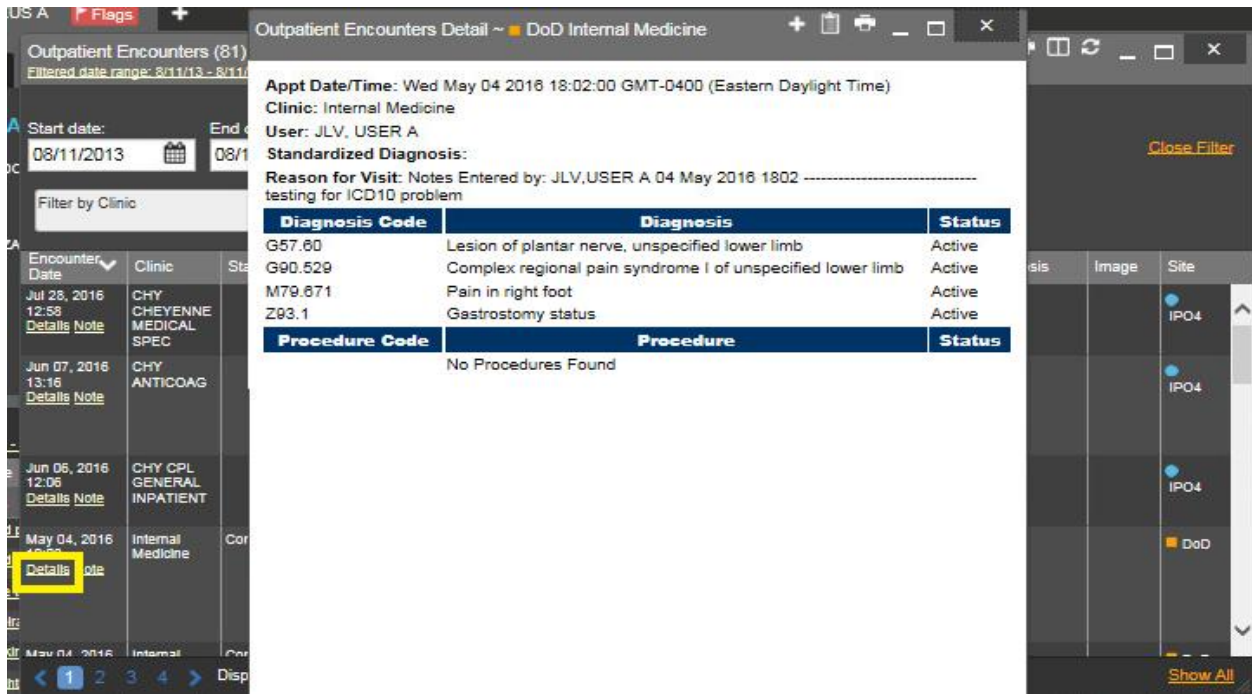

#### 4.5.6.3. Viewing Outpatient Encounter Notes

Where available, click a **Note** hyperlink in the **Encounter Date** column of either view of the **Outpatient Encounters** widget to view the note from the encounter (Figure 68).

Figure 68: Outpatient Encounters, Encounter Note Link

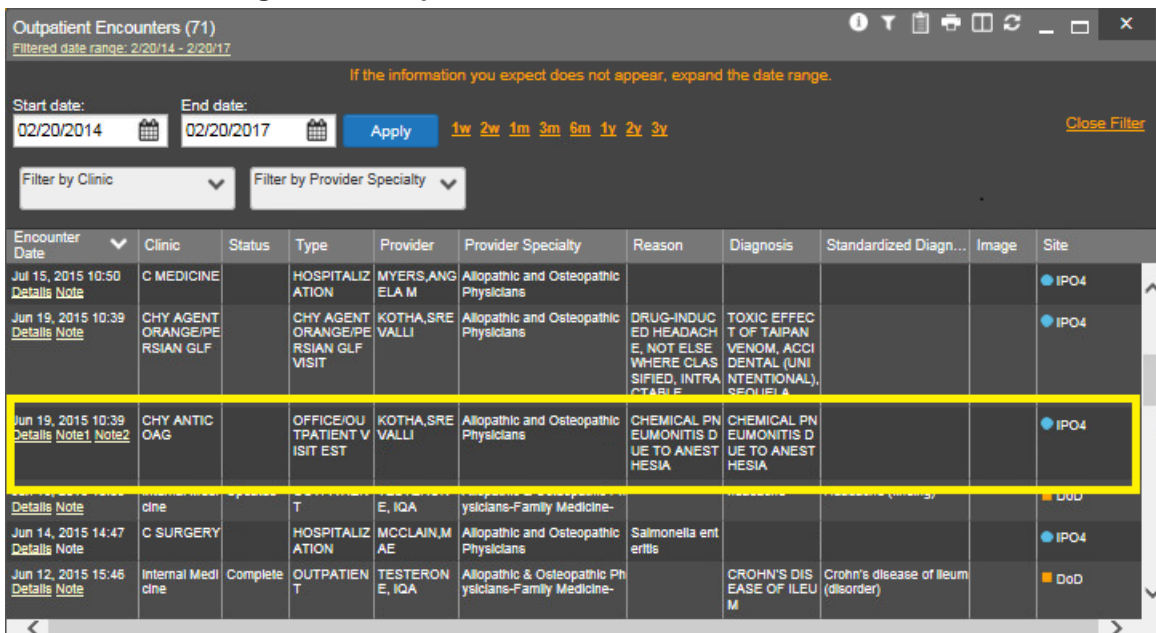

#### 4.5.6.4. Viewing Sensitive Data in the Outpatient Encounters Widget

Records marked **\*\*Sensitive\*\*** in the **Outpatient Encounters** widget ([Figure 69](#)) can be viewed, but the action will be recorded each time the sensitive record is clicked.

After clicking a **Details** or **Note** hyperlink in the **Encounter Date** column for a sensitive record, JLV notifies the user that they will be audited ([Figure 35](#)). This message is triggered each time a user clicks a sensitive record. After the user selects the purpose of viewing the record and agrees to be audited, sensitive data appears in the additional view, but the record remains masked in both the minimized and expanded views of the widget.

Figure 69: Outpatient Encounters Widget, Sensitive Record

Outpatient Encounters (71)  
Filtered date range: 2/20/14 - 2/20/17

If the information you expect does not appear, expand the date range.

Start date: 02/20/2014 End date: 02/20/2017 Apply 1w 2w 1m 3m 6m 1y 2y 3y Close Filter

Filter by Clinic: Filter by Provider Specialty

Encounter Date	Clinic	Status	Type	Provider	Provider Specialty	Reason	Diagnosis	Standardized Diagn...	Image	Site
Apr 24, 2014 16:16 <a href="#">Details</a> <a href="#">Note</a>	** Sensitive *	Complete	OUTPATIENT	TESTERONE, IQ A	Allopathic & Osteopathic Ph ysicians-Family Medicine-	** Sensitive **				Doc
Apr 24, 2014 14:46 <a href="#">Details</a> <a href="#">Note</a>	** Sensitive *	Updated	OUTPATIENT	TESTERONE, IQ A	Allopathic & Osteopathic Ph ysicians-Family Medicine-	** Sensitive **				Doc
Apr 23, 2014 17:12 <a href="#">Details</a> <a href="#">Note</a>	** Sensitive *	Complete	OUTPATIENT	TESTERONE, IQ A	Allopathic & Osteopathic Ph ysicians-Family Medicine-	** Sensitive **				Doc
Apr 23, 2014 16:47 <a href="#">Details</a> <a href="#">Note</a>	** Sensitive *	Complete	OUTPATIENT	TESTERONE, IQ A	Allopathic & Osteopathic Ph ysicians-Family Medicine-	** Sensitive **				Doc
Apr 23, 2014 16:19 <a href="#">Details</a> <a href="#">Note</a>	** Sensitive *	Complete	OUTPATIENT	TESTERONE, IQ A	Allopathic & Osteopathic Ph ysicians-Family Medicine-	** Sensitive **				Doc
Apr 23, 2014 14:56 <a href="#">Details</a> <a href="#">Note</a>	** Sensitive *	Updated	OUTPATIENT	TESTERONE, IQ A	Allopathic & Osteopathic Ph ysicians-Family Medicine-	** Sensitive **				Doc
Apr 23, 2014 14:32 <a href="#">Details</a> <a href="#">Note</a>	** Sensitive *	Complete	OUTPATIENT	TESTERONE, IQ A	Allopathic & Osteopathic Ph ysicians-Family Medicine-	** Sensitive **				Doc
Apr 23, 2014 13:34 <a href="#">Details</a> <a href="#">Note</a>	** Sensitive *	Updated	OUTPATIENT	TESTERONE, IQ A	Allopathic & Osteopathic Ph ysicians-Family Medicine-	** Sensitive **				Doc
Apr 23, 2014 13:18 <a href="#">Details</a> <a href="#">Note</a>	** Sensitive *	Complete	OUTPATIENT	TESTERONE, IQ A	Allopathic & Osteopathic Ph ysicians-Family Medicine-	** Sensitive **				Doc

Displaying 26-50 of 71 Show All

#### 4.5.6.5. Display and Filter Options

Display and filter options within the **Outpatient Encounters** widget include:

- Click a column title to sort records by that column. If a user sorts by a column that appears in both the minimized and expanded views of the widget, the sort will be saved in the user profile, and will appear in the next JLV session. If a user sorts on a column that is only in the expanded view of the widget, the next JLV session will restore the default widget sort, or the last sort saved to the user profile.
- Click the **Column Settings** icon  on the widget toolbar to show or hide the columns within the widget. Check/uncheck the column names that appear in the pop-up box, then click **Apply**.
- Specify the date range of the displayed records by using the **Quick Date Range Selector** or the **Start Date** and **End Date** calendars. If the expected information does not appear, use the **Start Date** and **End Date** filter options to expand the date range. When a date

range filter is applied, the date range is displayed in the widget header. Open or close the filter options by clicking the date range in the header.

- Use the **Filter by Clinic** dropdown to re-draw the widget to show only the records for the selected clinic(s). Only available in expanded view.
- Use the **Filter by Provider Specialty** dropdown box to re-draw the widget to show only the records for the selected provider type(s). Only available in expanded view.

#### 4.5.6.6. Terminology Normalization

Terminology normalization is provided in the **Outpatient Encounters** widget through the following GUI elements:

- The data in the **Provider** and **Provider Specialty** columns, in both the minimized and expanded views of the widget, are normalized to the NUCC standard. Hovering over entries in these columns displays the standardized name and code for the provider.
- The data in the **Diagnosis** and **Standardized Diagnosis** columns, in both the minimized and expanded views of the widget, are normalized to the Systematized Nomenclature of Medicine – Clinical Terms (SNOMED CT) standard. Hovering over entries in these columns displays the standardized name and code for the diagnosis.

[Figure 70](#) highlights a diagnosis mapped to the SNOMED CT standard. The standardized name and code are displayed in the hover text over the record in the **Diagnosis** column.

**Figure 70: Terminology Normalization – Outpatient Encounters**

Encounter Date	Clinic	Status	Type	Provider	Provider Specialty	Reason	Diagnosis	Standardized Diagnosis	Image	Site
Aug 11, 2014 14:54 <a href="#">Details</a> <a href="#">Note</a>	NHM/PTSD PROLONGED EXPOSURE		IN HOSPITAL	FOSTER,...	Allopathic and Osteopathic Physicians	DIAGNOSTIC SKIN AND SENSITIZATIC TESTS	DIAGNOSTIC SKIN AND SENSITIZATIC TESTS			IPO5
Jun 05, 2014 09:30 <a href="#">Details</a> <a href="#">Note</a>	W4U		HOSPITA...	MYERS,A...M	Allopathic and Osteopathic Physicians	PAIN IN THORACIC SPIINE				IPO5
Jun 03, 2014 14:03 <a href="#">Details</a> <a href="#">Note</a>	Internal Medicine	Compl...	OUTPATI...	TESTER... IQA	Allopathic & Osteopathic Physicians : Family Medicine		headache	Headache (finding)		DoD
Jun 03, 2014 13:41 <a href="#">Details</a> <a href="#">Note</a>	Internal Medicine	Compl...	OUTPATI...	TESTER... IQA	Allopathic & Osteopathic Physicians : Family Medicine			ding)		DoD
May 31, 2014 12:01 <a href="#">Details</a> <a href="#">Note</a>	NHM INPT REC THERAPY PM		NHM INPT REC THERAPY PM VISIT	PRATTEL... A MD	Allopathic and Osteopathic Physicians			Systematized Nomenclature of Medicine - Clinical Terms (SNOMED CT) Standardized Name: Headache (finding) Standardized Code: 25084002		IPO5
Apr 16, 2014 16:44 <a href="#">Details</a> <a href="#">Note</a>	** Sensitive **	Compl...	OUTPATI...	TESTER... IQA	Allopathic & Osteopathic Physicians : Family Medicine	** Sensitive **				DoD

## 5. Troubleshooting

The following subsections provide information about troubleshooting the JLV system.

### 5.1. Special Instructions for Error Correction

JLV utilizes access control and authentication services to limit access to registered, authorized users. When enabled, JLV validates a user against information retrieved from that user's SmartCard. If you are experiencing trouble logging in to JLV, and have used the correct URL for your agency, please review the following before contacting the ESD:

VHA users:

- Have accessed JLV using the VHA URL
- Have entered their existing CPRS access and verify codes correctly in the fields on the JLV Log in page
- Have selected a site from the **Site** dropdown list on the JLV Log in page. Most users must specify the individual facility name, or their parent healthcare system name

VBA users:

- Have accessed JLV using the VBA URL
- Have entered their existing CAPRI access and verify codes correctly in the fields on the JLV Log in page
- Have selected VBA from the Site dropdown list

#### 5.1.1. Log In Page Error Messages

Additional troubleshooting is provided in [Table 8](#).

**Table 8: Error Messages and Resolution Steps**

Error Message	Resolution Steps
Access denied. You are not an authorized user	<p><b>WHAT?</b> Error message indicating <i>Access Denied. You are not an authorized User.</i></p> <p><b>WHY?</b> PIV card processing problem or invalid security certificate chosen; no access to JLV because user is not authorized.</p> <p><b>FIX IT:</b></p> <ol style="list-style-type: none"> <li>1) Close browser window.</li> <li>2) Re-insert PIV card and re-launch JLV link.</li> <li>3) Select a certificate that is not expired and specifies <i>Issued by: Veterans Affairs CA B1.</i></li> </ol> <p>If this is unsuccessful, contact the ESD.</p>
Could not save User Profile	<p><b>WHAT?</b> Error message indicating <i>Could not save User Profile.</i></p> <p><b>WHY?</b> Error occurred during PIV authentication for VA users - typically a PIV card processing problem or an invalid security certificate chosen.</p> <p><b>FIX IT:</b></p> <ol style="list-style-type: none"> <li>(1) Close your browser window.</li> <li>(2) Re-insert PIV card and re-launch the JLV link.</li> </ol>

Error Message	Resolution Steps
	<p>(3) Select a certificate that is not expired and specifies <i>Issued by: Veterans Affairs CA B1</i>.</p> <p>If this is unsuccessful, close all open IE windows/tabs. Open IE and try JLV again.</p>
<p>Not a valid ACCESS/VERIFY CODE pair</p>	<p><b>WHAT?</b> <i>Not a valid ACCESS CODE/VERIFY CODE pair</i> error at login screen.</p> <p><b>WHY?</b> 1) JLV could not match your access and verify codes to the Site selected in the dropdown, or 2) Username and password were entered instead of access/verify codes.</p> <p><b>FIX IT:</b></p> <p>1) VHA users must select the parent VistA host site for their facility (e.g., Wichita uses <i>Kansas City, MO</i>).</p> <p>2) Re-enter correct Access and Verify codes (CAPRI codes for VBA users, CPRS codes for VHA users).</p>
<p>Page cannot be displayed</p>	<p><b>WHAT?</b> You receive a <i>Page cannot be displayed</i> error when launching JLV.</p> <p><b>WHY?</b> The JLV URL requires certain internet explorer settings</p> <p><b>FIX IT:</b></p> <p>1) With Internet Explorer open, click the Tools menu or press ALT-X.</p> <p>2) Select Internet Options.</p> <p>3) When the dialog opens, select the <b>Advanced</b> tab.</p> <p>4) Scroll down in the list until you see SSL 2.0 setting and ensure is NOT checked, and that Transport Layer Security (TLS) 1.0, 1.1 and 1.2 are checked.</p> <p>5) Click <b>OK</b>, then relaunch JLV and the page should load.</p>
<p>SmartCard required</p>	<p><b>WHAT?</b> Error Message <i>Smart Card Required</i>.</p> <p><b>WHY?</b> Smart card not read by Windows Security and JLV before launching JLV link.</p> <p><b>FIX IT:</b></p> <p>1) Close all browser sessions/browser-based applications.</p> <p>2) Re-insert PIV card and re-launch JLV link.</p> <p>If this is unsuccessful, close all open IE windows/tabs. Open IE and try JLV again.</p>
<p>VERIFY CODE must be changed before continued use</p>	<p><b>WHAT?</b> Receive <i>VERIFY CODE must be changed before continued use</i> error at login screen.</p> <p><b>WHY?</b> CPRS or CAPRI VERIFY CODE has expired.</p> <p><b>FIX IT:</b></p> <p>1) Open CPRS, VistA, or CAPRI (VBA users).</p> <p>2) Select the <b>Change Verify Code</b> checkbox on the sign-on dialog before clicking <b>OK</b>.</p> <p>3) You will be prompted to create a new verify code.</p> <p>4) Once your verify code is changed for CPRS or CAPRI, relaunch JLV and the new code will be recognized immediately.</p>

### 5.1.2. VistA Imaging Viewer Integration Error

When VistA Data Service or VistA Imaging Exchange interfaces are stopped or offline, JLV is unable to retrieve a context URL, and displays the following message: *Warning: An error occurred while attempting to retrieve VistA Imaging Viewer URL.*

When this message appears, JLV is unable to retrieve the necessary data object to launch a VistA Imaging Viewer instance from within JLV. This could indicate that either VistA Data Service or VistA Imaging Exchange is offline.

### 5.1.3. ‘Cannot View Patients’ Error

When access to patients is restricted for a VHA VA user, JLV will display a list of restricted patients in the **Patient List** window, immediately upon login. VHA users will only be able to select a patient from the list of pre-populated patients in the **Patient List** window. The pre-populated list represents the only patients the user is authorized to view. JLV will also replace the **Patient Search** link on the portal with a link to the restricted patient list.

### 5.1.4. System Error Messages

[Table 9](#) summarizes system messages that may be presented to JLV users.

**Table 9: System Error Messages**

Message	Description
Warning: An error occurred while attempting to retrieve VistA Imaging Viewer URL.	JLV will display this message when either VistA Data Service or VistA Imaging Exchange is offline and JLV is unable to retrieve the necessary data object to launch a VistA Imaging Viewer instance from within JLV.
MVI Message: There are no patients found using the current parameters.	No patient records were found using the information entered in the Patient Search dialog box. Re-enter patient identifiers in the Patient Search dialog box fields.
MVI Error: Patient not found with search elements entered, please provide additional patient identifying information and search again.	This message is presented to the user when a patient search is performed and the patient is not found with the identifiers used. Click <b>OK</b> in the dialog box presented to return to the Patient Search window and search for the patient again using additional search criteria or other patient identifiers.
MVI Error: Your query yields too many results. Please modify your search parameters to narrow the search.	JLV adheres to VA guidelines and blocks the search results when the search request yields more than 10 patients. Modify the information entered into the Patient Search dialog box to reduce the number of results by using additional search criteria, or other patient identifiers.
MVI Error: Application Reject. There was an error attempting to process your query. Please modify your search parameters and try again.	There may be one or more errors in the information entered into the Patient Search dialog fields. Please validate your patient identifiers and try the search again. If problems persist, there may be an error in the query from MVI to DEERS (external process to JLV) or an error occurred between MVI and DEERS.
You do not have authorization to view this record. Security regulations prohibit computer access to your own medical record.	Following VA security regulations, JLV does not allow access to a user’s own medical records.

Message	Description
You do not have authorization to view this record. Your SSN is missing from the NEW PERSON file. Contact your ACP Coordinator.	Following VA policy, JLV does not allow access to patient records if the JLV user's SSN is not in the user's VistA profile.

### 5.1.5. VA VLER Server Error Message

[Table 10](#) summarizes an error that may be presented to JLV users, related to the display of VA VLER data.

**Table 10: Community Health Summaries and Documents – VA Widget Error Message**

Message	Description
Error displayed in widget: <i>Something went wrong: Internal Server Error (500)</i>	This message will appear in the <b>Community Health Summaries and Documents – VA</b> widget when the VA VLER service is not available. If this message persists after 5 minutes, contact the ESD to report the connection error.

### 5.1.6. eHX Error Message

[Figure 71](#) will appear in a new browser tab when eHX does not return a document to JLV when a user tries to access/print a VLER record through the Report Builder, or tries to access a document in the Community Health Summaries – VA widget.

**Figure 71: eHX Error Message**

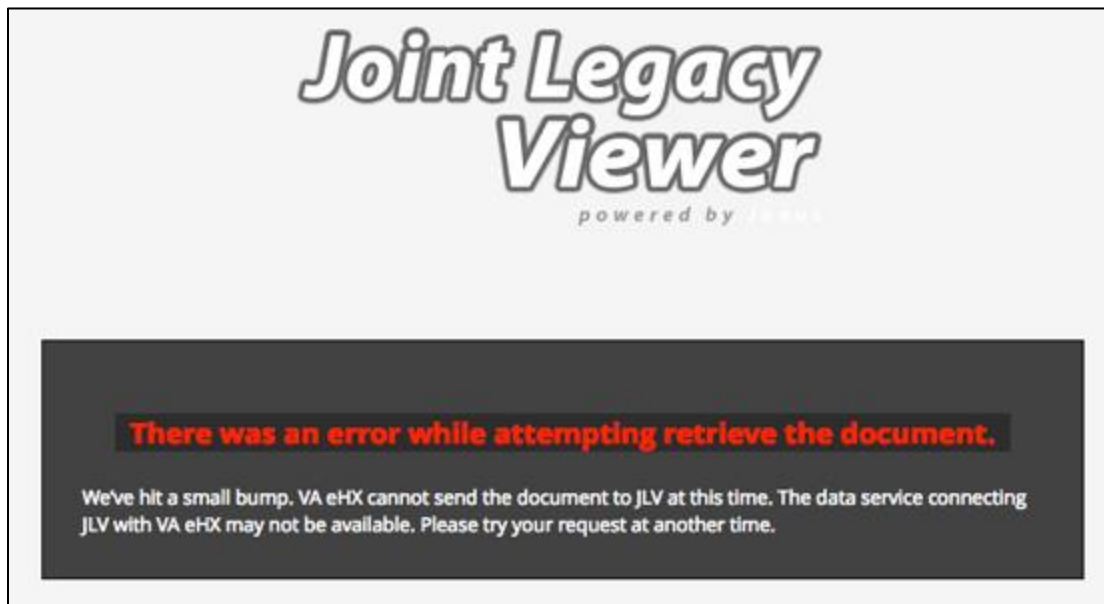

## 6. Acronyms and Abbreviations

[Table 11](#) lists the acronyms and abbreviations used throughout this document, and their descriptions.

**Table 11: Acronyms and Abbreviations**

<b>Acronym</b>	<b>Description</b>
AITC	Austin Information Technology Center
CAPRI	Compensation and Pension Record Interchange
CCD	Continuity of Care Document
CCDA	Consolidated Clinical Document Architecture
CCOW	Clinical Context Object Workgroup
CDC	Centers for Disease Control
COOP	Continuity of Operations
CPRS	Computerized Patient Record System
DES	Data Exchange Services
DIBR	Deployment, Installation, Backout and Rollback
DOB	Date of Birth
DoD	Department of Defense
EDIPI	Electronic Data Interchange Personal Identifier
EHR	Electronic Health Records
eHX	eHealth Exchange
ESD	Enterprise Service Desk
GUI	Graphical User Interface
HAIMS	Healthcare Artifact and Image Management Solution
HL7	Health Level 7
ID	Identification
IE	Internet Explorer
IEN	Internal Entry Number
IP	Internet Protocol
JLV	Joint Legacy Viewer
LOINC	Logical Observation Identifiers Names and Codes
MHS	Military Health System
MI	Middle Initial
MVI	Master Veteran Index
NUCC	National Uniform Claim Committee
OI&T	Office of Information and Technology
PDF	Portable Document Format
PDWS	Patient Discovery Web Service
PITC	Philadelphia Information Technology Center
PIV	Personal Identity Verification



<b>Acronym</b>	<b>Description</b>
POM	Production Operations Manual
QoS	Quality of Service
SDD	System Design Document
SNOMED CT	Systematized Nomenclature of Medicine - Clinical Terms
SSL	Secure Socket Layer
SSN	Social Security Number
TIU	Text Integration Utility
TLS	Transport Layer Security
TSPR	Technical Services Project Repository
UI	User Interface
URL	Uniform Resource Locator
VA	Department of Veterans Affairs
VBA	Veterans Benefits Administration
VDS	VistA Data Service
VHA	Veterans Health Administration
VistA	Veterans Health Information Systems and Technology Architecture
VLER	Virtual Lifetime Electronic Record