



VistA Imaging System

Technical Manual

July 2019 – Revision 46
MAG*3.0*204

Department of Veterans Affairs
Product Development
Health Provider Systems

**VistA Imaging Technical Manual
VistA Imaging MAG*3.0*204,
July 2019**

Property of the US Government

This is a controlled document. No changes to this document may be made without the express written consent of the VistA Imaging Product Development group.

While every effort has been made to assure the accuracy of the information provided, this document may include technical inaccuracies and/or typographical errors. Changes are periodically made to the information herein and incorporated into new editions of this document.

Product names mentioned in this document may be trademarks or registered trademarks of their respective companies, and are hereby acknowledged.

VistA Imaging Product Development
Department of Veterans Affairs

Internet: <http://www.va.gov/imaging>

SharePoint: <http://go.va.gov/VistAImaging>

Preface

The purpose of this manual is to provide information about the structure and function of the logical components of the Veterans Health Information Systems and Technology Architecture (VistA) Imaging V. 3.0 package (i.e., files, routines, and configuration that comprise the VistA Imaging System). Although this document describes some security functions, sensitive information regarding the VistA Imaging System can only be found in the Security Guide.

This document describes...

- How to implement and maintain the VistA Imaging System, its routines and files, options, and cross-references among files.
- How files are archived and purged.
- The established relations among the VistA Imaging System components and other components inside and outside of the Imaging software.

The VistA Imaging System Technical Manual is part of a suite of manuals that includes a release notes document, security guide, user manuals and installation guides. Information about various VistA Imaging System components (i.e., servers, workstations, and background processors) can be found in the Installation Guide.

The Food and Drug Administration classifies this software as a medical device. As such, it may not be changed in any way. Modifications to this software may result in an adulterated medical device under 21CFR820, the use of which is considered to be a violation of US Federal Statutes.

VA Policy states the following:

Those components of a national package (routines, data dictionaries, options, protocols, GUI components, etc.) that implement a controlled procedure, contain a controlled or strictly defined interface or report data to a database external to the local facility, must not be altered except by the Office of Information (OI) Technical Services (TS) staff. A controlled procedure is one that implements requirements that are mandated or governed by law or VA (Department of Veterans Affairs) directive or is subject to governing financial management standards of the Federal Government and VA or that is regulated by oversight groups such as the JCAHO or FDA. A controlled or strictly defined interface is one that adheres to a specific industry standard, will adversely affect a package and/or render the package inoperable if modified or deleted. For national software that is subject to FDA oversight, only the holder of the premarketing clearance (510(k)) is allowed to modify code for the medical device. The holder of a premarketing clearance is restricted to specifically designated TS staff that are located at the registered manufacturing site and operating in the designated production environment. Modifying FDA regulated software under any other conditions is a severe violation of the Code of Federal Regulations. Local, that is field-based, developers are prohibited from modifying national software that is certified by the FDA.

Revision History	
16 July 2019	MAG*3.0*204 --- E. Smith Update title page, footers, and TOC
2 November 2018	MAG*3.0*222 --- C. Andersen Updated section 9.4.2
1 November 2018	MAG*3.0*218 updates --- C.Andersen Updated section 6.2.1
4 October 2018	MAG*3.0*178,181,182,184,206 updates --- C. Andersen, L. Shope Added chapter 19, sections 19.1, 19.1.1, 19.2
1 October 2018	MAG*3.0*204 updates --- C.Andersen Updated sections 5.1, 6.3.5, 7.2.1
24 September 2018	MAG*3.0*162,166,174,180 --- C. Andersen Updated section 6.2.1
08 February 2018	MAG*3.0*188 , updates(rev 42) ---G. Kirin, K.Powell Updated section 7.2.1, Chapter 7 VistA Imaging System M Files VA FileMan Files - Added two rows to table : (MUSE TEST TYPES & MUSE FORMAT TABLE
2 Oct 2013	MAG*3.0*130, 131, 133, 135, 140 updates (rev 41)—C. Gilbert, L. Scorza, R. Price Updated for MAG*3.0*130, 131, 133, 135, 140 applying the changes to the proper base document Updated sections 3.5.2, 6.3.1, 6.3.5, 8.7, Chapter 9 (numerous changes throughout the chapter) 12.5, 12.7, 12.9.2, 12.9.2.2, Index - Deleted section A.2 BP Error Messages - Added section A.2, BP Troubleshooting
10 Sep 2013	MAG*3.0*130, 131, 133, 135, 140 updates (rev 41)—C. Gilbert, R. Price, C. Huth - Updated sections 3.6.2, 6.31 6.3.5, 8.7, 12.15, Index - Deleted section A.2 BP Error Messages - Added section A.2, BP Troubleshooting
26 August 2013	MAG*3.0*127 updates (rev. 40)—P. Yeager, A. Foster, C. Huth - Updated sections 3.3, 6.3.1, 6.3.3, 8.1, A.1 MAG*3.0*34/1116/118 updates (rev. 40)—P. Yeager, L. Scorza - Updated sections 1.4, 1.5, 1.7, 3.3, 3.6., 3.6.1, 3.6.5, 3.9, 4.1, 5.1.1, 5.2.1, 5.3.1.8, 5.3.1.9,5.3.1.10, 6.1, 6.1.1, 6.2.1,6.2.2, 6.3.4, 6.3.9, 7.2.1, 7.7, 7.8, 8.2, 8.5, 8.6, 8.9.1, 8.10.1, 9.1,12.4,12.5, 12.6,15.1, A.3, - Added sections 7.5, 7.6, 8.3, 8.4, 11.4, 11.4.1, 11.4.2.2,11.4.2.3 MAG*3.0*129 updates (rev. 40)—C. Gilbert, L. Scorza - Updated section 6.3.1
15 Mar 2013	MAG*3.0*124 updates (rev 39)—P. Yeager, H. Suri, C. Huth - Updated sections 1.7, 3.1, 8.3: changed title to MAG Reason Edit [Mag Sys Menu]; Index - Added section 3.6.5, Security Keys for AWIV Web Application
01 Dec 2012	MAG*3.0*122 and MAG*3.0*123 updates (rev 38) – C. Gilbert, P. Yeager, K. Bahr, L. Scorza. - Updated sections 3.6.1, 3.11, 6.1.2, 6.3.1, 7.2.1, 7.3.1.
01 Aug 2012	MAG*3.0*120 updates (rev 37) – N. Topalov, V. McDonald. - Added section 1.2, VistARad Product Perspective and Features. - Added section 1.8, Windows 7 Considerations. - Revised sections 2.1; 2.2; 2.3; 3.1.1; 3.2; 3.3; 6.3.1; and 8.12. - Replaced section 12.7, CCOW Communication, and retitled it as Context Management; added four new subsections. - Added new section 12.8, CPRS Tools Menu Option for VistARad.
25 Jan 2012	MAG*3.0*121 updates (rev 36) C.Gilbert, H. Suri, L. Scorza - Updated sections 6.3.2, 10.1 and 18.1.5 A.2.2. - Added new section 12.8.3.
09 Nov 2011	MAG*3.0*104 updates (rev 35) R. Coney, A. Sunbear. - Updated sections 1.6, 3.5 and 12.10 - Added new sections 6.3.8 and 9.9.
01 Sep 2011	MAG*3.0*49,99,117 updates (rev 34) L. Jenkins, M. Kaji, H. Suri, L. Scorza MAG*3.0*49 – Updated sections 6.3.4, 8.2, 8.3, 8.4, 8.7, 12.1, 12.4.2. Added new sections: 8.2.1, 8.2.1.1, 8.2.1.2, 12.2 12.3, 13.1.3, 13.1.4, 13.1.5. MAG*3.0*99 – Updated sections 6.2.1, 6.3.4. MAG*3.0*117 – Updated sections 3.6.2, 6.3.1, 7.2.1.

Revision History	
31 May 2011	MAG*3.0*39 updates (rev 33) C. Gilbert, D. White <ul style="list-style-type: none"> - Updated sections 1.3, 5.1.1, 5.1.2, 5.3.1.5, 5.4, 5.5, 6.3.2, 6.3.3, 7.2.1, 8.2, 8.4, 9.3.2, 9.3.3, 9.3.3.1.1 to 9.3.3.1.8, and modified Chapter 9 name - Added new sections 9.5.5 and 9.5.6 and renumbered existing subheadings affected -- Re-organized subheadings in Chapter 9 - Made global corrections listed on page 1 of the Change Pages document
10 May 2011	MAG*3.0*106 updates (rev 32) C. Gilbert, D. White <ul style="list-style-type: none"> - Updated sections 3.6.3, 6.3.1, and 7.2. Added new section 3.11.
21 Mar 2011	MAG*3.0*115 updates (rev 31) M. Kaji, M. Turian, J. Kennedy <ul style="list-style-type: none"> - Updated sections 6.3.5 and Appendix A.5 for Patch 115. - Added sections 12.9 and 13.2 for Patch 115.
01 Feb 2011	MAG*3.0*105 and 98 updates (rev 30) R. Coney, C. Gilbert, H. Suri, D. White <ul style="list-style-type: none"> - Updated section 1.6 for Patch 105 - Updated sections 5.6, 6.3.7, 9.5.2.2, 9.5.2.3.1 for Patch 98
01 Dec 2010	MAG*3.0*53 and 66 updates (rev 29). L. Jenkins, L. Scorza <ul style="list-style-type: none"> - Updated sections 3.3, 6.2.1, 6.3.4, 7.2.1, 8.7.1, 8.8.1, and 12.2.2 for Patch 53. - Updated sections 1. 4, 6.2.1, and 12.2.2 for Patch 66.
05 Oct 2010	MAG*3.0*108, 90, 94 and 114 updates (rev 28). M. Kaji, D. White, J. Kennedy <ul style="list-style-type: none"> - Updated sections 3.6.4, 6.3.5, and Appendix 5 for Patch 90. - Updated sections 3.6.2, 10, and 18.1 for Patches 94 and 108. - Updated sections 6.3.3 and 15.1 for Patch 114.
09 Jul 2010	MAG*3.0*83 updates, minor corrections (rev 27). R. Coney, A. McFarren <ul style="list-style-type: none"> - Updated sections: 1.4, 3.6.1, and 5.1.1; new sections 1.6, 3.5, and 12.8 for MAG*3.0*83. - General corrections: 6.1.2, 12.4, 18.1.1, and 18.1.2.
10 Feb 2010	Patch 93 and Patch 101 updates, general cleanup (rev 26). M. Kaji, D. White, J. Kennedy <ul style="list-style-type: none"> - Updated sections 3.6.2, 6.3.1, 7.2.1, 7.2.3, 8.2, 11.1.2 for Patch 93. - New sections: 8.2 subsections, 11.1.3.4, 11.1.3.5, 11.1.3.6 for Patch 93. - Updated Sections 3.6.4, 6.3.5, 7.2.1, and Appendix A.5 for Patch 101.
20 Oct 2009	Patch 72 and Patch 54 updates; general cleanup (rev 25). A. McFarren, S. Littles <ul style="list-style-type: none"> - Updated sections 3.6.1 and 6.3.1 for Patch 72. - Revised content in section 6.2.3 (detail moved to Security Guide); removed outdated information from 15.1, 18.1.1, and 18.1.2.
19 Aug 2008	Patch 95 updates and misc. cleanup (rev 24) A. McFarren, D. Carozza <ul style="list-style-type: none"> - Updated and formatted patch list in section 3.1 - Updated section 6.3.1 for Patch 95 - Remove obsolete section related to test images and demo mode (6.3.1.1, 6.3.1.2, and 11.3.4.); remove redundant screen shots from Chapter 7; correct outdated content in section 9.5.2.1 (JL)
29 Feb 2008	Patch 59 updates (rev 23) - S. Davis, C. Huesman <ul style="list-style-type: none"> - Updated sections 6.3.1 and 6.3.3 for Patch 59. - New section Appendix B and B.1 for Means Tests Patch 59.
14 Jan 2008	Patch 76 updates and misc. corrections (rev 22). –A. McFarren, C. Huesman <ul style="list-style-type: none"> - Clarify MAG_DECOMPRESSOR content in section 6.3.6. - Updated sections 3.6.4 and 3.6.5 for p76
15 Nov 2007	Patch 81 and 69 updates (rev 21) - S. Davis, A. McFarren, R. Coney. <ul style="list-style-type: none"> - Removed old info from chapter 17, added pointer to new info for p81 - Updated sections 6.2.1, 6.2.2, and 12.2.2; removed section 6.2.4 for p69
04 May 2007	Patch 77, 46 and 65 updates (rev 20) – S. Davis, A. McFarren, C. Huesman <ul style="list-style-type: none"> - Added revision # to revision table, title page, and footer, corrected typo in section 9.5.4.4. - Updated sections 8.2 and 12.5.2 for Patch 77. - New section 12.6 for Imaging site reports Patch 77. - Updated sections 3.1, 3.3, 6.4.1, 6.4.3, 7.2.1, 8.2, 12.3, and 15.1 for Patch 46. - New section 12.5 for CCOW communication Imaging site reports for Patch 46. - Updates sections 3.3, 7.2.1, and 8.7 for Patch 65.

Revision History	
21 Jul 2006	Patch 50 and 20 updates (rev 19) - S. Davis, A. McFarren, R. Coney. <ul style="list-style-type: none"> - Updated section 12.5.2 for patch 78. - Updated the following sections for patch 20: 1.3, 5.1.1, 5.3.1.5, 6.4.2-3, 9.3.2, 9.3.3.1.1-8, 11.1.1 and 12.5.2. - Updated section 7.2.1 for patch 50.
30 Jun 2006	Patch 51 and 18 updates (rev 18) – A. McFarren, C. Huesman. <ul style="list-style-type: none"> - Added new section 6.4.6 and updated section 7.2.1 for patch 51. - Updated sections 3.3, 3.6, 5.1.2, 6.4.5, 7.2.1, 8.3, and A.5 for patch 18. - Updated obsolete information in sections 1.4 and 7.2.3
12 Dec 2005	Patch 57 updates (rev 17) - A. McFarren, C. Huesman. <ul style="list-style-type: none"> - General typo corrections and formatting cleanup throughout document. - Removed old operating system references throughout document - Corrected/updated outdated content in sections 3.1, 3.6, 6.1.1, 6.3, 7.2.1, 8.2, 8.7, 9.5.4.4, and 12.5.2.1 - Removed outdated content from sections: 1.5.3, 3.3, 3.4, 5.2.1, 5.3.2, 5.5, 6.4.4.4.2, 6.4.5, 7.4, 9.5.4.4, 13.1.2, and A.3 - Incorporated p45 change page: new chapter 18 - New section 3.10 covering Microsoft patch installation.
5 April 2005	Additional Updates (rev 16): <ul style="list-style-type: none"> - Section 6.1.1 Checksums
28 Mar 2005	Additional Updates (rev 15): <ul style="list-style-type: none"> - Sections 6.4.1, 7.2.4, 10.2.3.1, 10.2.3.3, and 11.1.2, 16.1.2
9 Mar 2005	Patch 48 Updates (rev 14): <ul style="list-style-type: none"> - Sections 3.6 Security Keys, 6.1.1 Checksums, 6.4.1 Clinical Workstation Files, 6.4.2 Background Processor Files, 7.2.4 Further Information, 10.2.3.1 Input Array Sent to Import API, 10.2.3.3 Results Array Returned to Status Handler, 11.1.2 Delete Images and Pointers
30 Sept 2004	Patch 8 Updates (rev 13): <ul style="list-style-type: none"> - Section 3.3 Site Parameters - Section 3.6 Security Keys - Chapter 6 – Section 6.1.1 Routine Descriptions - Section 6.4.1 Clinical Workstation Files - Section 7.2.1 VA FileMan Files - Section 8.2 Imaging System Manager Menu - Section 10.2.3.1 Input Array Sent to Import API - Section 11.3.4 VistA Imaging Display, Demo Mode - Section 11.3.5 VistA Imaging Capture, Test Mode
23 June 2004	Patch 33 Updates (rev 12): <ul style="list-style-type: none"> - Section 6.4.1 Clinical Workstation Files - Appendix A.1 Clinical Workstation Error Messages - Appendix A.4 Setup Error Messages
30 April 2004	Patch 11 Updates (rev 11): <ul style="list-style-type: none"> - Chapter 6 Routine Descriptions - Section 7.2.1 VA FileMan Files - Section 8.9 Access to DICOM Gateway RPCs - Section 12.2.2 DICOM RPC Broker Calls
6 April 2004	Patch 3 Updates (rev 10): <ul style="list-style-type: none"> - Revised sections 8.2, 11.1.1, and 12.5.2.1 to reflect the removal of Edit Image Write Location - Removed redundant sections 8.2.1-8.2.1.2 (i.e.,MAG ENTERPRISE information already exists in section 12.5). - Documented revisions for patches 7, 17, 23, 27, 25, 22, and 10.
9 Dec 2003	Patch 10 Updates (rev 9): <ul style="list-style-type: none"> - Section 7.2.1 VA FileMan Files
5 Nov 2003	Patch 22 Updates (rev 7): <ul style="list-style-type: none"> - Appendix A.6 VistARad Error Messages
30 Sept 2003	Patch 25 Updates (rev 8): <ul style="list-style-type: none"> - Section 7.2.1 VA FileMan Files

Revision History	
23 July 2003	Patch 23 Updates (rev 6): - Section 8.2 Imaging System Manager Menu - Section 12.5 MailMan Messaging Patch 27 Updates: - Section 8.2 Imaging System Manager Menu - Section 12.5 MailMan Messaging
7 May 2003	Patch 17 Updates (rev 5): - Section 7.2.1 VA FileMan Files - Section 7.5 Imaging Entity Relationship Diagram and Detailed Information
30 April 2003	Patch 19 Updates (rev 4) to section 8.2 Imaging System Manager Menu
30 Mar 2003	Patch 16 Updates (rev 3): to Appendix A.5 VistARad Installation Error Messages
10 Dec 2002	Patch 9 Updates (rev 2): - Addition of files 2006.035, 2006.036, 2006.59, 2006.5906, 2006.596 - Additional fields for file 2005.2 - Additional security key MAGJ DEMAND ROUTE - Modification to table 3.3 (collapse line-items for DICOM Gateway)
6 Sept 2002	Patch 7 Updates (rev 1): - Created changes pages for Sections 3.6, and 7.2.1. - Chapter 10 – revised

Table of Contents

Chapter 1 Introduction.....	1
1.1 Multimedia Patient Record	1
1.2 VistARad Product Perspective and Features	2
1.3 Automated DICOM Image Acquisition.....	2
1.4 The VistA Imaging DICOM Gateway.....	2
1.5 The Hybrid DICOM Image Gateway	3
1.6 Background Processor	5
1.6.1 Queue Processor	5
1.6.2 Purge.....	5
1.6.3 Verifier	5
1.7 Typical Configuration.....	6
1.8 DICOM Gateway Networking Topology Options.....	6
1.8.1 Commercial DICOM Devices Connected to Main Network Backbone	6
1.8.2 Commercial DICOM Devices on Separate Physical Networks	7
1.9 Cross-Enterprise Image Sharing	7
1.10 Windows 7 Considerations	8
Chapter 2 Orientation.....	9
2.1 Documentation Conventions.....	9
2.2 Special Workstation Procedures	9
2.3 Mouse/Windows Controls	10
Chapter 3 Implementation and Maintenance.....	13
3.1 VistA Package Requirements	13
3.1.1 Packages Used in Conjunction with VistARad.....	13
3.2 Hardware and Software Requirements	14
3.3 Maintenance of Software on DICOM Gateway Workstations	14
3.4 Changes to IP Addresses or Ports	14
3.5 Security Keys.....	15
3.5.1 General Security Keys.....	15
3.5.2 Security Keys for Clinical Display.....	16
3.5.3 Security Keys for Clinical Capture	17
3.5.4 Security Keys for VistARad.....	18
3.5.5 Security Keys for AWIV Web Application	19
3.5.6 Security Keys for the DICOM Importer II.....	20
3.6 Workstation Hardware.....	21
3.7 Changes to DICOM Modalities	21
3.8 Changes to Windows Servers and Security	21
3.9 Microsoft Patch Installation Guidelines.....	21
3.10 Parameter Definitions	22
Chapter 4 Security Software Maintenance.....	25
4.1 Security and Anti-virus Considerations	25

Chapter 5	Space, Staffing, and Standard Operating Procedures for VistA Imaging	27
5.1	Infrastructure Resources	27
5.1.1	Networking	27
5.1.2	Space	27
5.1.3	Power	28
5.1.4	Remote Access	28
5.1.5	Security	28
5.2	Support	28
5.2.1	IRM Support Staff Requirements	28
5.2.2	Biomedical Engineering Support Staff Requirements	29
5.2.3	ADPAC Staff Requirements for Support for All Medical Services	29
5.3	Daily Activities	29
5.3.1	IRM Morning Routine	29
5.4	Maintenance	32
5.5	Weekly Activities	32
5.6	Other Periodic Activities	32
5.7	Scheduled Down Time for VistA Servers	33
Chapter 6	Routine Descriptions.....	35
6.1	VistA Imaging Routines on the VistA Hospital Information System.....	36
6.1.1	Build Checksums	36
6.1.2	Package Checksums	36
6.1.3	Routine Descriptions	37
6.2	DICOM Gateway Routines.....	38
6.2.1	Checksums of VistA Imaging DICOM Gateway Routines.....	38
6.2.2	DICOM Gateway Routine Descriptions.....	41
6.2.3	Kernel RPC Broker Routines	41
6.3	Non-M Routines Distributed as Executable Files.....	41
6.3.1	Clinical Workstation Files	42
6.3.2	Background Processor Files	50
6.3.3	Online Help Files.....	51
6.3.4	DICOM Gateway Files.....	51
6.3.5	VistARad Workstation Files	59
6.3.6	MAG_Decompressor Files.....	61
6.3.7	Storage Site Utilities.....	61
6.3.8	VIX Files	62
6.3.9	DICOM Importer II Client Files	62
Chapter 7	VistA Imaging System M Files.....	63
7.1	Introduction.....	63
7.2	VA FileMan Files that are Part of the VistA Imaging System	63
7.2.1	VA FileMan Files	63
7.2.2	More Detailed Information.....	72
7.3	Input Templates	72
7.3.1	Further Information	72
7.4	File List	73

Table of Contents

7.5	Files Introduced in MAG*3.0*34	74
7.6	Sort and Print Templates.....	77
7.7	File List	79
7.8	File Security	79
7.9	Global Journaling.....	83
7.10	VistA System Outages	83
Chapter 8 Exported Options.....		85
8.1	Introduction: INI File Setup and Configuration of Workstations.....	85
8.2	Imaging System Manager Menu [MAG SYS MENU].....	85
8.2.1	Imaging HI7 Messaging Maintenance [Mag HI7 Maint]	85
8.3	Configure AE Security Matrix Settings [MAGV AE SEC MX SETTINGS]	88
8.4	Delete Study by Accession Number [MAG SYS-DELETE STUDY]	89
8.5	Enter/Edit Reason [MAG REASON EDIT]	90
8.6	MAG Client Version Report [MAG CLIENT VERSION REPORT]	92
8.7	Imaging VistARad System Options.....	93
8.8	Imaging MAG WINDOWS Menu Option.....	93
8.9	Imaging VistaRad MAGJ VISTARAD WINDOWS	93
8.10	Imaging MAG JB OFFLINE Menu option.....	94
8.11	Imaging DICOM Menu.....	94
8.12	Imaging Menu Options Documentation.....	94
8.13	Access to DICOM Gateway RPCs	94
8.14	Imaging Menu Options Documentation.....	95
Chapter 9 Archiving, Purging, Verifying, and Backup.....		97
9.1	Introduction.....	97
9.2	Archiving and Purging of Image FileMan Entries.....	97
9.3	Archiving and Purging of Image Files.....	97
9.3.1	Automatic Image File Migration.....	97
9.3.2	Purging Tier 1 Shares	98
9.4	Queue Management	98
9.4.1	Server Size.....	99
9.4.2	Background Processor: Open Log Functions	100
9.4.3	Check Status of the JBTOHD Report.....	104
9.5	Background Processor Configuration Tools.....	104
9.5.1	Configuring BP Servers.....	104
9.5.2	Background Processor Purge Configuration	108
9.5.3	Network Location Manager: Adding a New Tier 1 or Tier 2 Storage Location and other Storage Types	113
9.5.4	Background Processor Imaging Site Parameters Edit Functions	115
9.5.5	Scheduled BP Verifier.....	121
9.5.6	Scheduled RAID Group Advance	123
9.6	Background Processor Image and File Entry Verifier.....	125
9.7	Imaging Server and Jukebox Backup Information	125
9.8	DICOM-related Backup and Purge.....	125
9.8.1	Growing entities	126

9.8.2	Tier 2 Archive	126
9.8.3	Purge Image Files from VistA Magnetic Cache Manually	128
9.8.4	Entities That Are Purged at the Discretion of the Site Supervisor	130
9.9	VIX-related Backups	131
Chapter 10 Callable Routines/Application Programmer Interfaces (APIs).....		133
10.1	Import API	133
10.1.1	VA Policy	133
10.1.2	FDA Policy.....	134
10.2	VistA Imaging Import API	134
10.2.1	Terms of Use	134
Chapter 11 Error Recovery, Troubleshooting, and Testing		135
11.1	Error Recovery.....	135
11.1.1	Server or Disk Drive Failure	135
11.1.2	Delete Image and Pointers.....	135
11.1.3	Correcting Image Capture Errors	136
11.2	Troubleshooting / Error Messages.....	137
11.3	Test Software Available for Troubleshooting.....	137
11.3.1	Introduction	137
11.3.2	PING, TRACERT	137
11.3.3	RPCTEST.EXE	138
11.3.4	VistA Imaging Capture, Test Mode	138
11.4	Handling Processing and Storage Errors in the New Data Structures	138
11.4.1	How the HDIG and the Archiver Handle Processing and Storage Errors.....	138
11.4.2	Getting Information About Processing and Storage Errors.....	139
11.4.2.2	Using Hybrid DICOM Gateway [MAGV HDIG MENU] Options to Get	140
Chapter 12 External Relations.....		143
12.1	HL7 Messages.....	143
12.2	HL7 Application Parameters.....	143
12.3	HL7 Logical Link	143
12.4	Imaging Broker Calls.....	144
12.5	Windows Messaging	144
12.6	Integration Agreements.....	144
12.7	Select the Context Management	145
12.7.1	Context Management	145
12.7.2	The Clinical Context Object Workgroup Protocol.....	145
12.7.3	The Context Management Settings Tab	146
12.7.4	Context Changes.....	146
12.8	CPRS Tools Menu Option for VistARad.....	147
12.9	Mailman Messaging.....	147
12.9.1	“Image Cache Critically Low” Messages	147
12.9.2	“Image Site Usage” Messages.....	148
12.9.3	Watermarking Messages	159
12.10	Imaging Site Reports.....	160
12.10.1	Document Counts Report	160

12.10.2	Image Count by User Report.....	161
12.10.3	Means Test Report.....	164
12.10.4	Package Index Contains ‘Note’ Report.....	165
12.11	VistA Site Service.....	169
12.12	VistARad External Relations.....	169
12.12.1	Voice Dictation Software	169
12.12.2	Medical Visualization/3D Reconstruction Software.....	169
12.12.3	Medical Imaging Resource Center (MIRC) “Teaching File” server.....	170
Chapter 13	Internal Relations.....	171
13.1	Dependencies	171
13.1.1	Entry/Exit Logic	171
13.1.2	Synchronization.....	171
13.1.3	Radiology HL7 v2.1 Protocols.....	171
13.1.4	Radiology HL7 v2.4 Protocols.....	172
13.1.5	VistA Imaging ADT Protocols.....	173
13.1.6	Radiology Protocols (VistARad).....	175
13.1.7	Patient Movement Protocol (DICOM).....	175
13.2	VistARad Internal Relations.....	177
13.2.1	VistA Site Service	177
13.2.2	VistA Imaging Exchange (VIX) servers	177
Chapter 14	Package-Wide Variables	179
Chapter 15	Online Documentation.....	181
15.1	Online Help.....	181
Chapter 16	Site-Specific Implementation	183
16.1	Site-Specific Implementation.....	183
16.1.1	Radiology Report Transcription Service.....	183
16.1.2	HL7 MESSAGE TEXT File (#772).....	183
16.1.3	Incomplete DICOM Files Received on the DICOM Image Gateway.....	183
Chapter 17	Database Integrity Checking	185
17.1	VistA Imaging MAG SYS MENU	185
17.2	Clinical Display Application.....	185
17.3	VistARad Application.....	186
17.4	Verifier Application in the Background Processor	186
Chapter 18	Remote Image Views.....	187
18.1	Configuration for Remote Image Views.....	187
18.1.1	Enabling/Disabling Remote Image Views for Site	187
18.1.2	Updating VistA Site Service URL	188

Appendix A Error Messages	191
A.1 Clinical Workstation Error Messages	191
A.2.2 Queue Processor Application Error Messages	211
A.2.3 Verifier Application Error Messages	217
A.2.4 Purge Application Error Messages	223
A.3 DICOM Gateway Error Messages	225
A.4 Clinical Display/Capture Setup Error Messages.....	225
A.5 VistARad Error Messages.....	225
Appendix B: Means Tests.....	234
B.1 Sending Means Tests to the HEC.....	235
Glossary	238
Index	240

Chapter 1 Introduction

1.1 Multimedia Patient Record

The VistA Imaging System is an extension to the Veterans Health Information System Technology Architecture (VistA) hospital information system that captures clinical images, scanned documents, motion images, and other non-textual data files and makes them part of the patient's electronic medical record. Electrocardiogram (EKG) waveforms can be displayed as part of the electronic medical record. Image and text data are provided in an integrated manner that facilitates the clinician's task of correlating the data and making patient care decisions in a timely, accurate way.

The system is designed to provide the treating physician with a complete view of patient data and, at the same time, allow consulting physicians to have access to the image and text data. It serves as a tool to aid communication and consultation among physicians -- whether in the same department, in different medical services, or at different sites.

The VistA Imaging System is unique in that management of the medical images is handled by the hospital information system, allowing very close integration of multimedia data with traditional patient chart information.

Clinical users can capture images during procedures or images can be added at a later time, for example during the creation of a report or progress note. Automatic image acquisition can be performed by DICOM gateways. Images can be acquired from commercial radiology Picture Archiving and Communications Systems (PACS) or directly from radiology devices. The transfer of patient demographic and order information to the commercial PACS or radiology device plays a key role in the ability to add these images to the patient's online medical record.

VistA Imaging workstations located throughout the hospital capture and display a wide variety of medical images including:

- Cardiology
- Endoscopy (GI, pulmonary, cystoscopy, arthroscopy, bronchoscopy, etc)
- Ultrasound (vascular, echo cardiology)
- Microscopic (Surgical Pathology, Cytology, Autopsy, Hematology)
- Surgery
- Ophthalmology
- Dental
- Dermatology
- Radiology images
- Nursing
- Podiatry
- Scanned advanced directives, consent forms, and other documents

VistA Imaging VistARad diagnostic workstations are generally located in the Radiology Reading room and are used for softcopy reading of Radiology images. These workstations provide functions for the Radiologist to retrieve and display full-resolution images, associated Radiology reports, and update the Radiology exam status.

1.2 VistARad Product Perspective and Features

VistARad is a VistA Imaging software component that provides filmless radiology functionality for radiologists and non-radiology clinicians. This maintenance patch (Maintenance VII) addresses various user needs including routine maintenance items, as well as two items described in this document that affect low-level design of certain features already implemented. In addition, support for patient context management is added to the design to eliminate potential safety concerns for those clinicians that require access to VistARad functionality and concurrent use of the VA Computerized Patient Record System (CPRS) and other CCOW-enabled applications.

The following product features and/or design modifications are included in Patch 120 and described in this document:

- Patch 120 provides support for the Windows 7™ operating system. The client installation file included with this patch will execute on either Windows XP™ or Windows 7. Certain installation details differ according to the target installation environment. These differences are noted elsewhere in this document.

Note: Some legacy display adapters for high-resolution screens may no longer be supported under Windows 7.

- Changes to the dictation system integration feature reduce potential mismatches between displayed exams and the accession number provided to the dictation system under certain usage scenarios.
- An added feature to the Teaching File interface allows the user to remove Personally Identifiable Information (PII) from images that have PII burned into the image pixel data. Previously, such “burned in” data could not be removed from images used for teaching purposes, raising a patient confidentiality issue. See the *VistARad User Guide, Teaching Files*.
- Patient Context Management Support is discussed. See section 0.

1.3 Automated DICOM Image Acquisition

DICOM is the abbreviation for the **D**igital **I**maging and **C**ommunications in **M**edicine standard. DICOM brings open systems technology to the medical imaging marketplace and enables VistA to communicate directly with commercial medical imaging equipment.

DICOM is a set of networked client/server applications that are implemented on top of TCP/IP. DICOM is part of the VistA networked application suite, along with CPRS, Kernel Broker, MS Exchange, and Windows-based file servers. Similar networking techniques are used for installing and maintaining all of these applications.

1.4 The VistA Imaging DICOM Gateway

The VistA Imaging DICOM Gateway, referred to as the DICOM Gateway for short, is a suite of VA-developed software that facilitates the transmission of DICOM images between the

image acquisition modalities¹ and the equipment on which these images are permanently stored. The images and information about them are stored in the VistA database as a part of the patient record. Once images have been stored in the system, they are available for viewing from any VistA clinical or diagnostic workstation.

The VistA Imaging DICOM Gateway can have these functions, depending on its configuration:

- Text Gateway – A gateway that distributes event data from the VistA Hospital Information System to image acquisition modalities and Picture Archiving and Communication Systems (PACS). For more information, see the *VistA Imaging DICOM Gateway User Guide*.
- Image Gateway – A gateway that transfers image files from an acquisition modality or a commercial PACS to VistA, or from VistA to workstations or commercial PACS. For more information, see the *VistA Imaging DICOM Gateway User Guide*.
- Routing Gateway – A gateway that transmits studies acquired at one VistA site to a storage location at another VistA site. For more information, see the *VistA Imaging DICOM Gateway Routing Setup and User Guide*.

1.5 The Hybrid DICOM Image Gateway

The Hybrid DICOM Image Gateway (HDIG) is a component of the DICOM Image Gateway, introduced in MAG*3.0*34 to enable the storage of the SOP classes for which support was introduced in MAG*3.0*34.

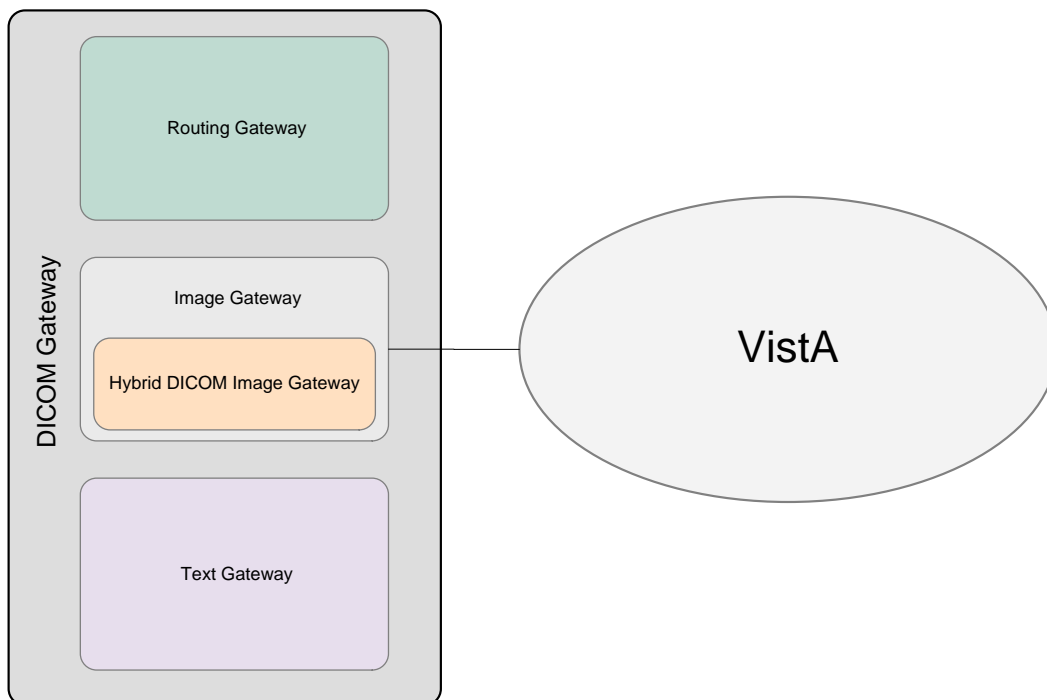

¹ The term “modality” is from the DICOM standard and denotes any equipment that produces images.

The HDIG includes these components:

- **DICOM Listener.** The DICOM Listener listens on a specific port for incoming DICOM objects from DICOM devices (Application Entities, or AEs) that are pre-defined in the DICOM AE SECURITY MATRIX. It validates all Service Object Pair (SOP) classes for which support was introduced in MAG*3.0*34 and stores the DICOM objects that pass the various validation checks in the new database structures. It forwards the SOP classes that were supported before MAG*3.0*34 for storage in the old database structures. The DICOM Listener includes:
 - The server side of the Query/Retrieve application (Query/Retrieve for short). Query/Retrieve is an application that allows pre-defined application entities to query the VistA database. For more information about Query/Retrieve, see the *VistA Imaging DICOM Gateway User Manual*.
 - The server side of the DICOM Importer II. The DICOM Importer II application provides the ability to import studies acquired at external facilities into the VistA database. It also provides a user-friendly graphical user interface for using DICOM Correct to correct errors in the processing flow. For more information about the DICOM Importer II, see the *DICOM Importer II User Manual*.
- **Archiver.** The Archiver archives the SOP classes for which support was introduced in MAG*3.0*34.
- **New Abstract Maker.** The new Abstract Maker creates abstracts (thumbnail icons) for the SOP classes for which support was introduced in MAG*3.0*34.

The following figure shows the HDIG components. You can select all components during installation, except the server side of the Query/Retrieve application (implemented in MAG*3.0*116) and the server side of the DICOM Importer II application (implemented in MAG*3.0*118), which are installed with the DICOM Listener.

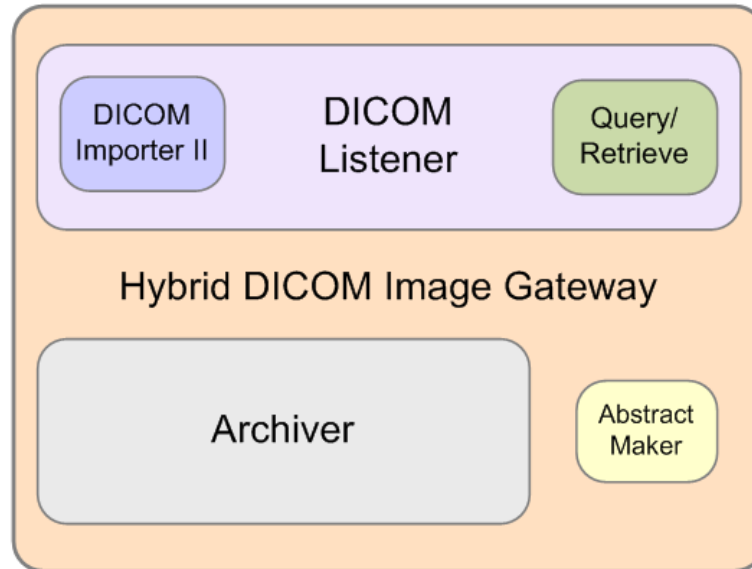

For more information about installing the HDIG and its components, see the *VistA Imaging DICOM Gateway Installation Guide*.

From Patch 204 onward, the HDIG application will only run on 64-bit operating systems (Windows 2008 64-bit, Windows 2012, etc.) This software has not been tested on Windows 2016.

1.6 Background Processor

The VistA Imaging Background Processor is a component in the VistA Imaging System and runs on a Windows file server. The Background Processor ensures the archiving of DICOM and clinical images from short-term storage (RAID groups) onto Tier 2 for long-term storage. These images are stored indefinitely on the archive device.

1.6.1 Queue Processor

The Queue Processor moves image data between Tier 1 and either remote or local Tier 2 storage. This activity is in response to activity from Capture and Display application requests.

1.6.2 Purge

The Purge removes image files from the Tier 1 based on file dates. An automatic purge process can be configured when Tier 1 storage becomes low and a regularly scheduled purge can be configured to operate during off-peak hours.

1.6.3 Verifier

The Verifier maintains and checks data integrity between the VistA Imaging database and the storage network location.

1.7 Typical Configuration

The diagram below shows a typical configuration of a VistA Imaging system.

VistA Imaging Network Topology

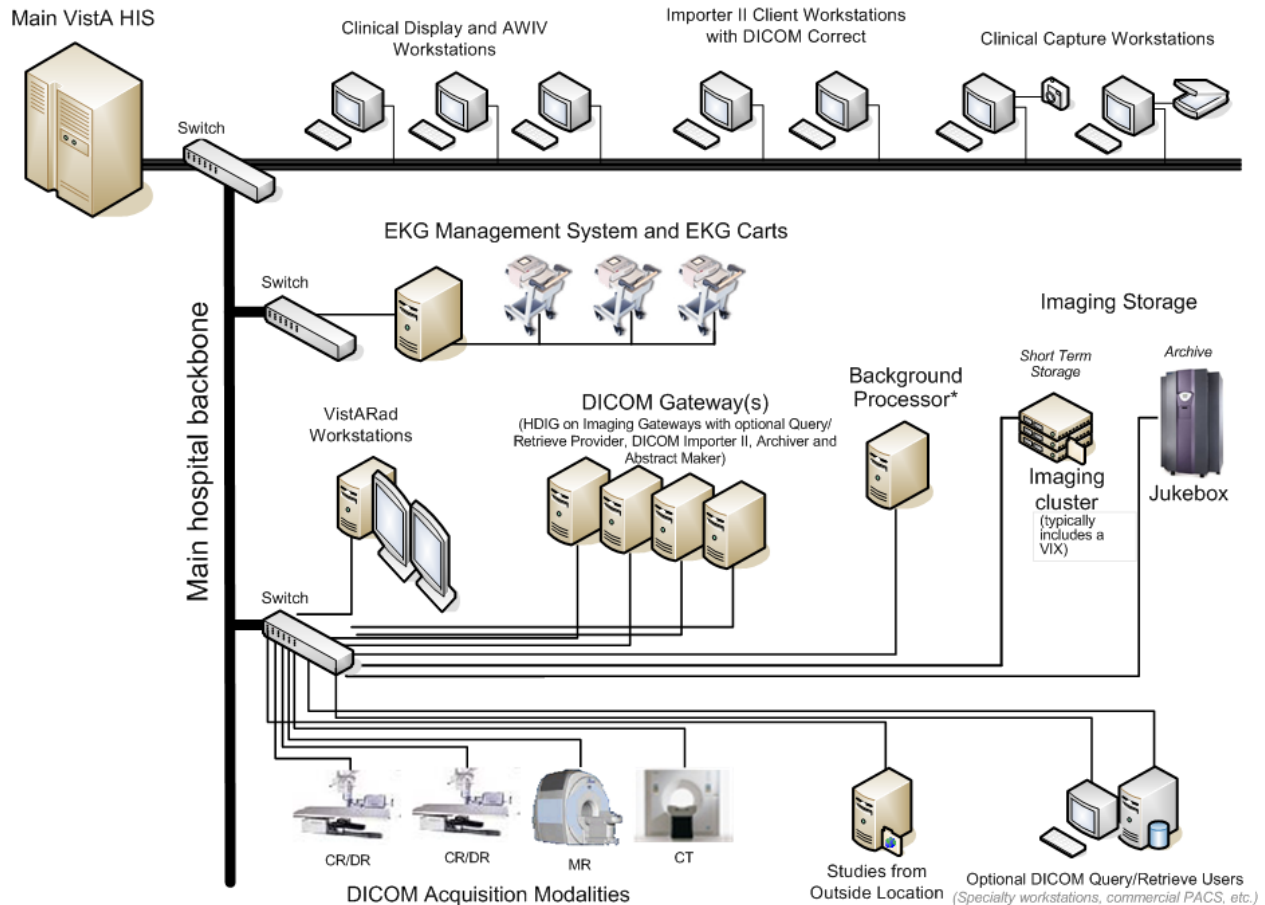

1.8 DICOM Gateway Networking Topology Options

The VistA DICOM Gateways may use either one or two networking interfaces depending upon whether the commercial DICOM devices are directly connected to the main network backbone or are located on separate physical networks.

1.8.1 Commercial DICOM Devices Connected to Main Network Backbone

Some sites may choose to have all devices (workstations, main hospital computer, DICOM imaging producing equipment, etc.) connected to a single high-speed switched network backbone. In this case, the VistA Image Servers, VistA DICOM Gateways, and Background Processor will all connect to the same switch on the high-speed backbone. Clinical and capture workstations will be connected to segments that feed into the backbone.

Single High-Speed Switched Network

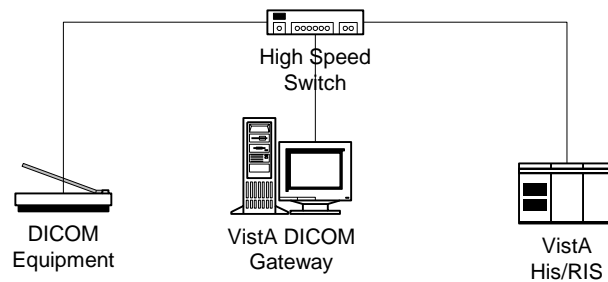

1.8.2 Commercial DICOM Devices on Separate Physical Networks

Other sites may choose to have a separate dedicated network for the commercial DICOM devices and DICOM gateways. In this case, the VistA DICOM Gateway must have two network interfaces, one to connect to the main hospital network backbone, and the second to connect to the dedicated network for the commercial DICOM devices. This keeps the traffic on the two networks separate.

Separate Dedicated DICOM Network

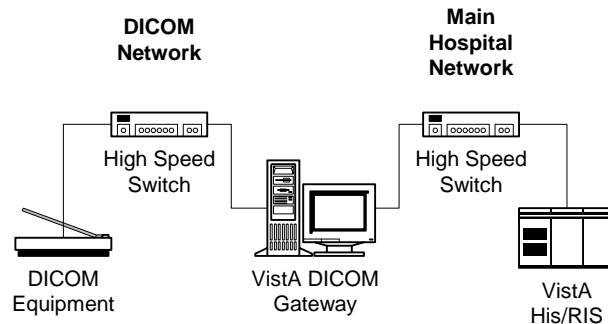

1.9 Cross-Enterprise Image Sharing

Sites that implement the VistA Imaging Exchange (VIX) service get:

- More efficient access to all types of remotely stored images and image-like artifacts (such as scanned documents) from other VA sites that also have a VIX.
- Remote radiology worklist monitoring and access to remotely stored radiology exams, using VistARad, without the need for routing.
- Access to DoD images for shared VA/DoD patients.

For more information about the VIX, see the *VistA Imaging VIX Administrator's Guide*.

Sites that implement the Advanced Web Image Viewer (AWIV) get:

- The ability for users to view images, progress notes, radiology reports, and other artifacts from within VistAWeb.
- User access to images from any VA site via the Centralized VistA Imaging Exchange (CVIX) service, which is an extension of the VIX service.

For information about using the AWIV, see the *VistA Imaging AWIV User Manual*.

Sites that implement the Advanced Web Image Viewer (AWIV) Web Application get:

- The ability for users to access images using the AWIV through Microsoft Internet Explorer.
- User access to all patient images from all sites at which a patient has been seen, not just the images associated with progress notes or radiology reports.
- User access to DoD artifacts, radiology images, and NCAT reports.
NOTE: The NCAT system must be online and available in order for AWIV users to view NCAT reports.
- User access to images via the AWIV using a thin client.

For information about using the AWIV WA, see the *VistA Imaging AWIV Web Application User Guide*.

1.10 Windows 7 Considerations

VistARad runs successfully under Windows 7. The documentation will point out any differences when necessary, using notes such as the following:





Note: Restrictions on access to root directories (including C:\) mean that ordinary users cannot create files in the root directory C:\.

Some “system” file pathnames (including those for the VistARad application itself) are different on Windows 7 systems. See section 6.3.1 for details.

Chapter 2 Orientation

2.1 Documentation Conventions

The following conventions are used in this manual.

Convention	Description
Regular Type	System-generated menu, dialog, output, etc. (in VistA screenprints)
Bold Type	User Keyboard Entry (in VistA screenprints)
[XTSUMBLD-CHECK	Routines, VistA Menu options
<Enter>	 Enter (Return) key
<Shift>	 Shift key
<A>, <2>, <F2>	Alpha, numeric or function key
<Esc>	 Escape key
<Num Lock>	 <p>Top left key on the numeric keypad (above the 7); may also be labeled <Numeric Lock>. It is equivalent to the <Caps Lock> used for alphabetic keys.</p> <p>If <Num Lock> is on, the keypad key will produce the number shown on its surface.</p> <p>If <Num Lock> is off, the keypad key moves the cursor as indicated by the label or symbol on the key; for example, the keypad <6> key will move the cursor to the right.</p>



2.2 Special Workstation Procedures

Command	Action
Reboot	<ul style="list-style-type: none"> • Push the RESET button on the front of the workstation. • If there is no RESET button, power the workstation off and then on; the workstation will reboot. • The workstation will perform a virus check and load all required software; this takes about 30-60 seconds. • When the reboot process is complete, you should be able to sign

Command	Action
	back into the workstation.

2.3 Mouse/Windows Controls

Control	Description
Mouse button click	<ul style="list-style-type: none"> • The mouse is a device used to point at positions on the screen. • The mouse may have one, two, or three buttons. • The mouse should be held at the end opposite the cord so the fingers can press the buttons. • The buttons are referred to as the "Right Mouse Button," the "Left Mouse Button", and the "Center Mouse Button." One kind of mouse, known as a "wheel mouse," has a wheel in the center instead of a button. The wheel is normally used for scrolling up and or left to right on a screen. When the mouse is rolled around on a flat surface, the arrow cursor on the screen will move correspondingly. • Pressing and releasing a button is called "clicking". You may position the arrow over a portion of the window, such as a button or scroll bar, and then click. This will cause the computer to do something such as display an image, depending on the window. • When the instructions tell you to "press the mouse button," you can assume that you are to press the left mouse button. • When it's necessary to use the right mouse button, you will be told to "right click." This is used, for example, to select items from a drop-down list or menu.
Select	<ul style="list-style-type: none"> • You may also select a rectangular area on the window, by following these steps: • Position the arrow cursor so it is over the left upper corner of the area to be selected. • Press the left mouse button down and hold it down while you move the mouse to the right lower corner of the rectangle to be selected. • Release the mouse button. You will see a dotted rectangle on the window around the area selected.

Control	Description
Drag	<ul style="list-style-type: none"> • If you want to move a window to another area of the window (e.g., to see something on a window that is underneath), follow these steps: • Position the cursor over the top colored title area of the window to be moved. • Press the left mouse button down, hold the mouse button down, and move the mouse until the window is where you want it. • Release the left mouse button. • This is called "clicking and dragging" a window.
	<ul style="list-style-type: none"> • You may adjust the size of the window by following these steps: • Place your mouse at the edge of the window that you would like to move. • When you see the cursor turn into a double headed arrow () , hold the left mouse button down, and move the mouse until the image is the width and/or height that you would like. • Release the left mouse button.

This page is intentionally left blank.

Chapter 3 Implementation and Maintenance

3.1 VistA Package Requirements

The VistA Imaging System is designed to be used in conjunction with the following VistA packages: Kernel, FileMan and RPC Broker are required packages; other packages depend on the site's implementation requirements.

3.1.1 Packages Used in Conjunction with VistARad

The VistA Imaging System is designed to be used in conjunction with the following VistA packages. Kernel, FileMan and RPC Broker are required packages. Other packages will depend on the site's implementation requirements.

Package Name and Version	Required For
kernel v. 8.0	Kernel is a vendor-independent applications development environment, as well as a run-time environment providing standard vendor-independent services to applications software. It is not an operating system, but a set of utilities and associated files that are executed in an M environment.
FileMan v. 22	<p>VA FileMan creates and maintains a database management system that includes features such as:</p> <ul style="list-style-type: none"> • A report writer • A data dictionary manager • Scrolling and screen-oriented data entry • Text editors • Programming utilities • Tools for sending data to other systems • File archiving <p>VA FileMan can be used as a standalone database, as a set of interactive or "silent" routines, or as a set of application utilities; in all modes, it is used to define, enter, and retrieve information from a set of computer-stored files, each of which is described by a data dictionary.</p>
RPC Broker 1.1	Interfacing with the hospital database
Consult/Request Tracking v. 3.0	Capturing images to the Consult/Request Tracking package
Medicine v. 2.3	Capturing images to the Medicine package

Package Name and Version	Required For
Laboratory v. 5.2	Capturing images to the Laboratory package
Radiology v. 5.0	Capturing images to the Radiology package
Surgery v. 3.0	Capturing images to the Surgery package
TIU v. 1.0	Capturing images to the Text Integration Utility package
PIMS v 5.3	Displaying Patient Profile report and patient security lookup
Health Summary 2.7	Displaying Health Summary report

3.2 Hardware and Software Requirements

Contact your Implementation Manager for information about VistA Imaging equipment.

The VistA Imaging software requires that a network be present with sufficient capacity to transport image files in a reasonable amount of time. All network set-ups must be completed **before** VistA Imaging workstations can be installed.

3.3 Maintenance of Software on DICOM Gateway Workstations

This section is obsolete as of the release of Patch 11. Refer to the Imaging DICOM Gateway Installation Guide for information about software installation and maintenance.

3.4 Changes to IP Addresses or Ports

Any changes to the IP addresses for the VistA servers or changes to the Kernel RPC Broker Listening port(s) will require updating on the VistA Imaging workstations (refer to the Broker Technical and User Manuals).

The VistA Site Service will also need to be updated with the changes. (If the site service is not updated, remote VA sites will not be able to access locally stored images.) For information about the VistA Site Service, see section 12.11.

Sites that have implemented a VIX will need to update their VIX's configuration to use the new site service values. This is done by re-running the VIX installer. Contact VHAVIVIXSETUP@va.gov for guidance.

Sites that have implemented a VIX will also need to update their VIX's configuration after the site service has been updated. This is done by re-running the VIX Installation wizard which will detect the new connection information and reconfigure the VIX accordingly. See the *VIX Installation Guide* for more information.

3.5 Security Keys

There are a number of security keys associated with the VistA Imaging system. The following tables summarize security keys and their function.

3.5.1 General Security Keys

Note: Please be cautious when assigning the following keys; the keys are intended for Imaging Support personnel. Review the descriptions before assigning these keys.

General Security Keys	
MAG ANNOTATE MGR	This key gives the holder full annotation access at the local site. The holder can add, edit, and delete annotations. Permissions provided by this key apply only to images at the site where the user has the key. This key also allows users to create annotations regardless of the settings of the user's account in the PARAMETER DEFINITION (MAG IMAGE ALLOW ANNOTATE) specified at a given site.
MAGDFIX ALL	Allows the holder to perform DICOM CORRECT functions on any entry in the DICOM FAILED IMAGES file (#2006.575). Users who do not hold this key will only be able to correct entries that were captured on their own site's gateway.
MAG DELETE	This key allows the holder to delete images from the IMAGE file (#2005) and from the new data structures. Pointers in parent packages such as Medicine, Surgery, Lab, Radiology, and TIU will also be deleted for images in file (#2005).
MAG PREFETCH	This key allows a user to 'PreFetch' or Queue all images for a patient. This means that all images for a patient that are on the jukebox will be copied from the jukebox to the magnetic server cache.
MAG SYSTEM	Given to person(s) managing VistA Imaging Systems. Required to modify site parameters via the Background Processor or to modify workstation parameters via the MAGSYS application. Also enables the display of DICOM header data for radiology images on Clinical Display workstations.
MAG VIX ADMIN	This key grants access to the VIX transaction log and to update HDIG administration parameters (HDIG service accounts access/verify code and email addresses). This key should be assigned to VIX administrators, to the DICOM service account, and the Imaging System Manager account. For more information, see the <i>VIX Administrator's Guide</i> .

3.5.2 Security Keys for Clinical Display

The following keys are used for display of images and should be limited to appropriate personnel:

Display-related Security Keys	
MAG RAD SETTINGS	User can edit the CT Presets in the Clinical Imaging Display Radiology Viewer window.
MAG ROI	User can print, copy images, or make release of information (ROI) requests without having to enter an electronic signature. This key should be assigned only to the HIMS Release of Information Officer.
MAGDISP ADMIN	User can display administrative images/documents.
MAGDISP CLIN	User can display clinical images/documents.
MAG EDIT	The MAG EDIT key is used to correct an image field when an index field is incorrect or incomplete, such as correcting a wrong specialty that was selected. Only users assigned the MAG EDIT key can edit an image. The MAG EDIT key is also required to access the QA Review Utility when performing quality assurance reviews of the scanned images. Only the Chief, HIM or authorized designated personnel (e.g., VistA Imaging Coordinator, Scanning Supervisor) should be assigned this key.
MAG PAT PHOTO ONLY	User can view only the patient photo.
MAG QA REVIEW	User can access QA Review and QA Review Report from Clinical Display Utilities Menu.
MAG REVIEW NCAT	User can view NCAT reports.
MAG VIEW DOD IMAGES	In Patch 72 and 93 versions of Clinical Display, users must have this key to display DoD images. In newer versions of Clinical Display, this key is not checked.

3.5.3 Security Keys for Clinical Capture

Note: If the 'CAPTURE KEYS' site parameter has been initialized, the following keys will need to be assigned appropriately.

Capture-related Security Keys	
MAG CAPTURE	Allow capture of images without an associated specialty (i.e. 'NONE' on the Imaging Capture configuration window).
MAG NOTE EFILE	User can electronically file notes without an electronic signature from the Imaging Capture workstation.
MAGCAP ADMIN	Allow capture of images associated with the 'Admin Document' specialty.
MAGCAP CP	Allow capture of Clinical Procedure images.
MAGCAP LAB	User can capture Laboratory images from the Imaging Capture workstation.
MAGCAP MED C	User can capture Cardiology images from the Imaging Capture workstation.
MAGCAP MED G	User can capture GI images from the Imaging Capture workstation.
MAGCAP MED GEN	User can capture Generic Medicine images from the Imaging Capture workstation.
MAGCAP MED H	User can capture Hematology images from the Imaging Capture workstation.
MAGCAP MED HI	User can capture Internal Medicine / Hematology images from the Imaging Capture workstation.
MAGCAP MED I	User can capture Internal Medicine images from the Imaging Capture workstation.
MAGCAP MED N	User can capture Neurology images from the Imaging Capture workstation.
MAGCAP MED P	User can capture Pulmonary / Endoscopy images from the Imaging Capture workstation.
MAGCAP MED PF	User can capture Pulmonary Function Test images from the Imaging Capture workstation.
MAGCAP MED R	User can capture Rheumatology images from the Imaging Capture workstation.
MAGCAP MED Z	User can capture Consult images from the Imaging Capture workstation.
MAGCAP PHOTOID	User can capture Photo ID images from the Imaging Capture workstation.

Capture-related Security Keys	
MAGCAP RAD	User can capture Radiology images from the Imaging Capture workstation.
MAGCAP SUR	User can capture Surgery images from the Imaging Capture workstation.
MAGCAP TIU	User can capture TIU images from the Imaging Capture workstation.
MAGCAP TRC	User can capture images associated with a "TeleReader Consult" from the Imaging Capture workstation.

3.5.4 Security Keys for VistARad

The following keys are related to VistARad and should be limited to appropriate personnel:

VistARad-related Security Keys	
MAGJ DEMAND ROUTE	User can access VistARad's on-demand routing capability. On-demand routing can be used to manually send exams to remote sites. For more information, refer to the <i>VistA Imaging Routing User Guide</i> .
MAGJ DEMAND ROUTE DICOM	Allows the user to use the on-demand routing function to queue exam images to be routed to selected remote DICOM destinations. This function only works for sites that have been configured for routing of images. An updated Routing agreement needs to be submitted and approved by the VistA Imaging Group before this function can be used.
MAGJ OVERRIDE ANNOTATIONS	Grants to a radiologist user of VistARad access to the menu option 'Override Annotations' when viewing an exam whose status is 'Complete.' This functionality is detailed in the <i>VistARad User Guide</i> .
MAGJ REMOTE ACCESS CONTROL	Allows a VistARad user to access the Monitored Sites configuration subset of the VIX Configuration settings tab, and to view exam list data in the Monitored Sites tab of the Manager.
MAGJ SEE BAD IMAGES	User can view images in VistARad that are associated with an exam that has failed the "Patient Safety" database checks.
MAGJ STORE IMAGES	Allows VistARad users to save Voxar images as secondary captures to VistA.

VistARad-related Security Keys	
MAGJ SYSTEM MANAGER	Allows access to Voxar-related settings in the VistARad Settings dialog. Grants access to additional data in the Imaging Internal Data display window. This functionality is detailed in the VistARad User Guide and Imaging System Installation Guide. Should only be assigned to VistARad administrators. Assigned only to VistARad administrators. Grants access to the Local Site VIX configuration subset of the VIX Configuration tab.
MAGJ SYSTEM USER	Allows a user to create and delete site-level hanging protocols, templates, and image presets associated with the VistARad 'sysAdmin' user.
MAGJ VOXAR COPYIMAGE	Allows VistARad users to copy images using Voxar (Enables the Copy to Clipboard button in the Voxar Reading manager window; refer to Voxar documentation for more information.)
MAGJ VOXAR EXPORTCAPTURE	Allows VistARad users to export images using Voxar (Enables the three Export -related buttons in the Voxar Reading manager window; refer to Voxar documentation for more information.)
MAGJ VOXAR PRINTCOMPOSER	Allows VistARad users to print images using Voxar (Enables the Print Composer button in the Voxar Reading manager window; refer to Voxar documentation for more information.)

3.5.5 Security Keys for AWIV Web Application

Users at the medical centers are allowed to view images based on their levels of access and/or user rights. Users must have at least one of the following keys to access images using the AWIV Web Application.

AWIV-Related Security Keys	
MAG REVIEW NCAT	User can view NCAT reports.
MAGDISP ADMIN	User can display administrative images/documents.
MAGDISP CLIN	User can display clinical images/documents.
MAG PAT PHOTO ONLY	User can view only the patient photo.
MAG ROI	User can print or copy images without entering an electronic signature; granted only to HIMS Release of Information officer.

NOTE: The NCAT system must be online and available in order for AWIV users to view NCAT reports.

Veterans Benefit Administration (VBA) users can view images without security keys, with the exception of NCAT reports.

3.5.6 Security Keys for the DICOM Importer II

The following keys are related to the DICOM Importer II and should be limited to appropriate personnel:

Security Keys for the DICOM Importer II	
MAGV IMPORT MEDIA STAGER	Allows DICOM Importer II users to stage (copy) from media to staging persistent storage, where it waits for reconciliation processing.
MAGV IMPORT STAGE MEDIA ADV	Allows DICOM Importer II users to: <ul style="list-style-type: none"> • Stage (copy) study level artifacts from media to staging persistent storage and • View images on the media.
MAGV IMPORT RECON CONTRACT	Allows DICOM Importer II users to: <ul style="list-style-type: none"> • Stage media at the study level • View images on the media • Associate study DICOM objects with an existing Radiology or Consult order for reconciliation.
MAGV IMPORT RECON ARTIFACT	Allows DICOM Importer II users to: <ul style="list-style-type: none"> • Stage media at the study level • View images on the media • Associate study DICOM objects with an existing Radiology or Consult order for reconciliation. • Place new Radiology orders using the Importer II user interface. • Use DICOM Correct to fix errors in studies in the DICOM Correct queue. • Manage the DICOM Importer II queue • Run, view, print and save DICOM Importer II reports
MAGV IMPORT REPORTS	Allows DICOM Importer II users to view, print, and save reports to a text file.

3.6 Workstation Hardware

Workstations tend to collect dust inside of the chassis. They should be periodically opened and cleaned. The accumulation of dust can lead to heat damage of workstation components. Only a qualified individual should do further hardware maintenance.

The monitors used with the VistARad diagnostic workstations require periodic calibration to maintain the proper grayscale luminance display characteristics necessary for accurate image quality. A program of maintenance for these monitors should be established and administered by the Biomedical Engineering staff. A calibration/maintenance log should be kept, as such documentation may be required for review by regulatory bodies.

3.7 Changes to DICOM Modalities

When DICOM Modalities are added, or operational parameters are to be modified, see the *VistA Imaging DICOM Gateway User Manual* for the procedures to record the appropriate new values for the various parameters.

3.8 Changes to Windows Servers and Security

Any changes to Image server shares or server security require updates to VistA files. See the *VistA Imaging System Installation Guide* for details.

3.9 Microsoft Patch Installation Guidelines

Sites should use the following guidelines for installing Microsoft patches on VistA Imaging Clinical workstations, DICOM gateways, VistARad workstations, DICOM Importer II workstations, and Imaging file servers.

The nature of the Microsoft patch dictates if it should be installed immediately, after validation, or not at all. For any patch that is installed, use steps detailed in “Procedures for Updates” below.

- **Critical security updates** - Install immediately after they are released from Microsoft.
- **Service Packs** - VistA Imaging will verify with solution vendors that there are no known issues and then will field test the service packs at 4 test sites with monitoring. The field test will last approximately 2 weeks. If no issues arise, all sites will be instructed to install the service pack.
- **Internet Explorer major version upgrades** – Are to be handled the same as service pack updates.
Note: IE-related critical security updates should be installed immediately after they are released from Microsoft.
- **Minor software updates** (media player, etc.) – Do not install unless validated by the VistA Imaging team.

Procedure for updates (critical components)

All updates should be applied methodically to critical Imaging components (file servers, gateways, VistARad Workstations).

1. Ensure that all VistA Imaging components are working properly before installing any updates.
2. Ensure that service packs, non-critical Internet Explorer upgrades, and minor software updates are validated by VistA Imaging (see above).
3. Schedule the installation for a time when system usage is low (in case a reboot is required).
4. Apply each update one at a time.
5. Apply each update to one critical system. Monitor that system for at least 1 day before updating other systems.
6. Do not load updates on all critical systems without first testing on a single system of each type.
7. Report any problems to the National Help Desk immediately.

Notes for Clinical Workstations

For clinical (non-diagnostic) workstations, the following is recommended:

- Microsoft patches should be loaded one at a time, and onto a single workstation only.
- After verifying that the workstation works properly, and that no unexpected issues arise, the patch can be installed on all workstations.

Any problems should be reported to the National Help Desk.

3.10 Parameter Definitions

MAG TR ALLOW THIN CLIENT

Sites will be able to configure whether or not TeleReader will be able to access and read images on a workstation that accesses VistA Imaging through a Thin Client.

MAG IMAGE ALLOW ANNOTATE

This parameter definition controls the ability of users at a specific site to create annotations based on the following hierarchical levels:

- User
- Service
- Division
- System

The VistA administrator or Information Resources Management (IRM) personnel can allow users to create annotations by changing the value of the parameter MAG IMAGE ALLOW ANNOTATE for an individual user account, for the users of a specific service at the site, for the user accounts that are part of a division, or for the entire site.

Authorized users can access the MAG IMAGE ALLOW ANNOTATE parameter through the VistA menu option [XPAR EDIT PARAMETER].

This page is intentionally left blank.

Chapter 4 Security Software Maintenance

4.1 Security and Anti-virus Considerations

VistA workstations are multi-purpose, multi-function medical systems. These workstations usually enable the users to run all of the VA's application software (including VistA Imaging), the Microsoft Office Suite, e-mail, Internet and other commercial products, as needed by the hospital staff. The workstations should be configured to provide medical information security (as specified by the VA's security staff), and they must have the latest version of anti-virus software protecting them.

Additionally, if these workstations will be used to stage or import images from media (CD/DVDs), the media drives must be enabled. Ensure that the anti-virus software is configured to scan all files being staged, imported or copied from media.

Windows security features should be used to restrict user access and protect system and other areas that should not be accessed by users. For additional information, see the *VistA Imaging Installation Guide* and the *VistA Imaging DICOM Gateway Installation Manual*.

VistARad Diagnostic workstations must be excluded from automatic software update/inventory tracking packages, and any client software supporting these cannot be installed. For information about removing System Center Configuration Manager (SCCM), please review the *VistA Imaging Installation Guide*.

This page is intentionally left blank.

Chapter 5 Space, Staffing, and Standard Operating Procedures for VistA Imaging

5.1 Infrastructure Resources

5.1.1 Networking

VistA Imaging Clinical Workstations run best with at least a 100 mb/s network, however they can be run over a 10 mb/s network.

The Background Processor (BP) application operates on a Windows-based PC. It is recommended that it operate on a file server that has a minimum of two gigabytes of RAM.

The VistA Imaging DICOM Gateway requires a hospital network infrastructure having a backbone that will support Ethernet segments with at least 100 megabits per second throughput. It is best to place the servers and Background Processor on the same switch with the gateways. The HDIG runs several services that use several ports to communicate. These ports must be open. It is recommended the HDIG operates on a file server with eight gigabytes of RAM, the minimum is four gigabytes of RAM.

VistA Imaging VistARad workstations should be on their own separate 1Gb/s network connection to the file servers whenever possible. This is especially important when more than two diagnostic workstations are in use in the radiology department. The VistARad workstations can run acceptably on a 100Mb/s network, but speed of image retrieval and display may be compromised.

The VistA Imaging Exchange (VIX) service can be set up on the clustered server used for Imaging shares (recommended) or on a dedicated standalone server. If the VIX is set up on a standalone server, the server should have a 4Gb/s network connection to the Imaging cluster. For more information about the VIX, see the *VistA Imaging VIX Administrator's Guide*.

5.1.2 Space

Each VistA Imaging DICOM Gateway runs on a Windows-based workstation with a monitor having a resolution of 1280x1024 pixels or better. Space is required for the system, its monitor, keyboard and mouse.

The Background Processor runs on a Windows-based file server and requires similar physical space.

The VistARad software runs on a Windows-based workstation using one to four monitors having a resolution sufficient for diagnostic reading. An additional workstation running voice dictation software may be present as well. Allow adequate space for the workstation(s), all monitors, keyboards, pointing devices, and dictation devices. In addition, plan for adequate room cooling and for room lighting that is suitable for diagnostic reading requirements.

5.1.3 Power

It is strongly recommended that the power supply to each VistA Imaging server, jukebox, DICOM Gateway, and Background Processor be safeguarded by means of an Uninterruptible Power Supply (UPS). This will reduce line voltage problems as well as protect against power outages.

5.1.4 Remote Access

In order to allow the VistA Imaging Project Support Staff to gain access to the servers and workstations that are running the VistA Imaging, a copy of either PC-Anywhere (preferred) or Remotely Possible (servers) must be installed on each server or workstation. These should be configured as a *host*. These systems should never be hooked up to a modem.

5.1.5 Security

Remote access must be password protected. Be sure to keep the VistA Imaging Project Support Staff updated when any such passwords are changed.

5.2 Support

5.2.1 IRM Support Staff Requirements

IRM support for VistA Imaging may require one or more staff members, depending on the size of the installation. These staff members must possess knowledge of VistA, Microsoft Windows, networking, and troubleshooting problems with Windows and TCP/IP. These staff members will need administrator privileges and should have a good foundation in Windows to cover troubleshooting, permissions and set-up. Network support will be needed to troubleshoot and maintain routing, wiring and configurations where packet filtering is in use.

Team members should be comfortable with the following areas:

- *User Manager* for Domains
- Setting permissions
- Shares
- *Server Manager* for setting up shares
- *Event Viewer*
- *Ping, TraceRT, NetStat, and DICOM_Echo*
- *TCP/IP troubleshooting techniques*

These staff members will be responsible for supporting Windows-based magnetic and jukebox servers, installing VistA Imaging patches, correcting information in VistA relating to the relationships between patients and images, installing workstations and workstation capture devices, and managing the Background Processor and DICOM gateways. This staff member is responsible for assigning Imaging security keys and menus to the users.

VistA package support staff should cover the installation of Imaging KIDS patches and issues like translation tables and journaling. In addition, a staff member with experience in M should be

available to assist in editing global variables and using FileMan to make corrections as necessary to correct situations such as the incorrect assignment of an image to a patient.

5.2.2 Biomedical Engineering Support Staff Requirements

Someone experienced in Biomedical Engineering and/or network support will be needed to install and troubleshoot modalities, display and capture workstations, capture devices, network and server systems, and to calibrate diagnostic workstation monitors. The amount of time required for these duties will vary with the size and specifics of the installation.

This staff will be responsible for ensuring that the modalities maintain their connections to the network and are able to communicate with the gateway systems. These staff members should be able to monitor modality traffic and to distribute modality traffic over different gateway processors, depending upon local traffic conditions and circumstances.

5.2.3 ADPAC Staff Requirements for Support for All Medical Services

These staff members will need to know how to use, teach, and support the VistA Imaging system. They should have a close relationship with the IRM staff so that problems may be reported and so that they may be of assistance in the resolution of these problems. The ADPACs will need to assist in implementing and customizing the VistA Imaging System for various specialties. They will need to trouble-shoot issues related to how VistA Imaging System fits into the practice of medicine. They will be the first line of support in the use of the VistA Imaging package and will need to assist the end-users. ADPACs should be able to train key users who can then, in turn, train other users on the VistA Imaging System.

The ADPACs will be responsible for being key advocates of the VistA Imaging system. It is essential that the ADPACs be proactive people. They will need to “walk the hospital” in the morning to be sure that users are not having problems. They will need to check on the modalities to ensure that they are working properly. These staff members may also be called upon to assist in correcting image header information, so that images are properly assigned to the right patients. The correcting of image headers is an event that does not happen often but one that may occur when the modality does not have an automatic worklist capability but requires end-user interaction to provide the patient name, social security number, and radiology accession number.

5.3 Daily Activities

Standard practices should be followed, including doing complete backups prior to installation of any new software or patches. For every processor in the suite of equipment for the VistA Imaging system, documentation should be maintained indicating what versions of which software are running and when new versions or patches are installed. In addition, this documentation should include information on the dates of installation, and who participated in the installation of software, patches or updates, and any unusual occurrences at the time of installation. Records should be kept of any problems that occur at the site, their cause and resolution.

5.3.1 IRM Morning Routine

Each morning the standard operating procedure should be to perform the tasks listed below in order to ensure the normal daily operation of the system.

5.3.1.1 Check the Imaging Network

Use Ping and other utilities, such as browsing, to ensure that all servers, gateways and modalities are reachable through the network.

5.3.1.2 Check Tier 2 for Sufficient Platters in the Write Path

Physically check Tier 2 and its console to see which platters are currently loaded. Ensure that there are sufficient disks loaded to cover the day's operations and that there are new ones available to be used when needed.

5.3.1.3 Check Current Write Locations for Sufficient Disk Space

Check the disk space on the servers and gateways. If images are accumulating on the Image Gateway and are not being passed to the VistA Imaging Servers, check for gateway problems. Correct any header information to associate images with the correct patient and allow the gateway to get the images in question moved to the VistA Imaging Servers.

5.3.1.4 Check the Event Viewer Trap on Imaging Network

Use the *Event Viewer* (under Administrative Tools) to display alerts. These logs may be filtered to show only warnings and alerts. It is a good practice to periodically save these logs to removable media and flush the logs. This will keep disk space usage to a minimum and still allow for old logs to be viewed.

5.3.1.5 Check the Imaging Background Processor

Failed queues can be noted in the Queue Activity window in the BP Queue Processor window. Active and failed queue status, system wide, can be accessed from the menu option: View|Purge Re-queue by type.

Use the Queue Manager on the Background Processor to check for details about failed queues. The Queue Manager should be invoked by using the menu on the BP Queue Processor window.

To check the failed queues, select **Edit | QueueManager| All or Edit | QueueManager| {queue}** and browse by queue type. The failed queues are sorted by error status.

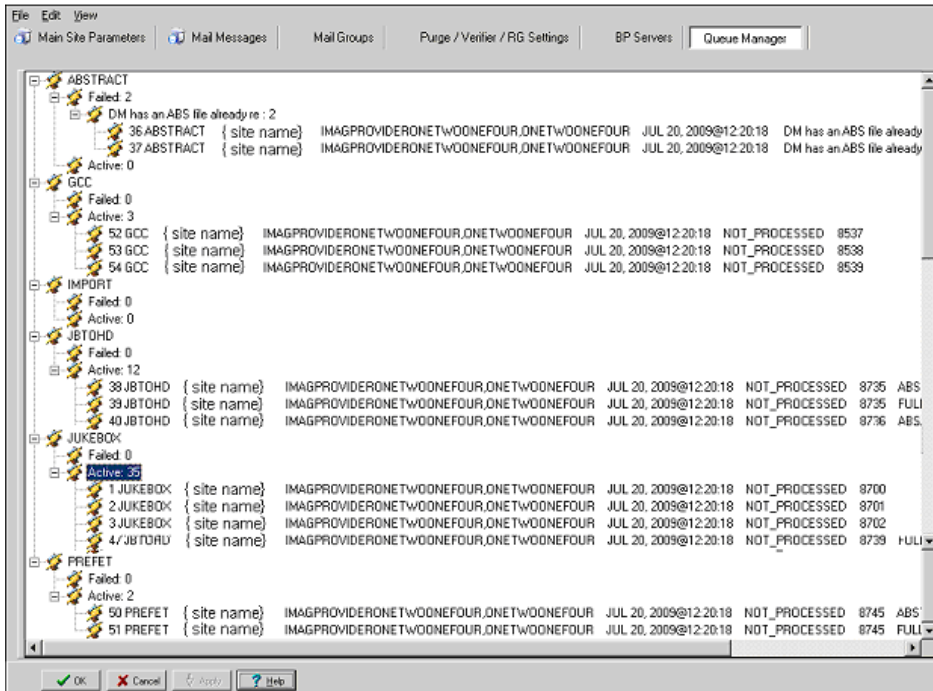

Alternately select Edit|QueueManager | *Queue Type*

This information will provide some insight as to what processes are failing and why. Right-clicking in the message or group level provides a menu to Re-Queue or Purge Queue.

5.3.1.6 Check that the DICOM Image and Text Gateways are Up and Functioning

Look for any error messages in the open windows. For each processor, make sure that there are windows open for listening and accepting images from those modalities that are assigned to that processor. MSM must be up and running on all gateways, as well as the display windows for the various monitoring sessions. If any of these are not running, restart them. Be sure that the Vista HIS is running.

5.3.1.7 Check that the DICOM Image Gateway Modalities are Sending Images

The ADPACs and end-users will generally let the IRM know if the modalities are not able to send or store images, however, it is good practice to check on this at the beginning of the day. Check the queue lengths.

5.3.1.8 Review the Image_In Directory for Incomplete DCM Files

Review the entries in the Dicom\Image_In directory for any files with “_incomplete” appended to the file name. These are incomplete files received by a modality or a PACS interface that the DICOM image gateway could not process. Research the files to see if the entity resent them at a later time or the images were never received. These files will automatically be purged after one hour.

On the main hospital system, check to see if the DICOM FAILED IMAGES file (#2006.575) has entries that need correcting. If there are “failed image files”, work with the ADPACs and end-

users to correct the information in the image headers and to associate these image files with the correct patients.

5.3.1.9 Review the M Error Traps

Review the M error traps on all of the DICOM Gateways and the main hospital system. Look for error messages related to the imaging routines (MAG*). If there are any errors that cannot be resolved by the local IRM staff, log a Remedy call so the VistA Imaging support staff may assist in their resolution. However, local IRM staff can easily address most error conditions.

5.3.1.10 Check the Hybrid Image DICOM Gateway (HDIG) Statistics and Log Files

For information about accessing the HDIG statistics and logs, see the *VistA Imaging DICOM Gateway User Manual*.

5.4 Maintenance

Do an incremental tape backup of all active Imaging Tier 1 shares (for new images captured) or update copy media if doing media copies on the Tier 2 shares. Active Tier 1 shares can be isolated by RAID group configuration.

5.5 Weekly Activities

A RAID Group is a group of one-to-many shares that will be recognized as a unit within the Imaging storage network. Its purpose is to reduce the number of active storage shares in order to facilitate quicker tape backups (both incremental and full). Newly acquired images are distributed evenly among all the shares within a RAID Group.

Do a full backup of active Imaging Tier 1 shares using the procedures in place at your site. For additional information, refer to Appendixes B and C in the *VistA Imaging Installation Guide*.

5.6 Other Periodic Activities

Support for the VistA Imaging systems includes activities for support of Windows-based servers and the VistA System. Backups should be made for all systems. Current patches should be loaded for VistA. Service Packs for Windows and updates to the VistA Imaging software should be installed as they are released.

- Use the BP Queue Manager to re-queue failed entries and to purge the queues.
- Use the MagUtility program to maintain Tier 1 and Tier 2 storage resources. For details, see the *Storage Utilities User Manual*.
- Review the monthly Image Site Usage mail message to ensure all workstations have latest software installed.
- Before installing any new software or patches, first do a full backup, including the Registry files.
- For the VistARad diagnostic workstation monitors, calibration should be checked on a scheduled basis, at least monthly—more frequently is preferred. Consult the recommendations of the monitor manufacturer. Re-calibration should be performed whenever the calibration check reveals a need to do so. Also, whenever any part of the

monitor/video driver hardware configuration is altered, a new calibration must be performed. Examples of configuration changes include: re-setting brightness or contrast controls; removing or replacing a monitor; removing or replacing a video board; replacing the system PC; etc.

5.7 Scheduled Down Time for VistA Servers

During a VistA System outage, DICOM Gateways will continue to provide modality worklist functionality and to capture images that are temporarily stored on the gateway. This is important to allow the radiology department to continue to perform studies. If you anticipate that the VistA System must be down, it is best to take the following steps:

- Perform all DICOM fixes before the VistA System goes down. This will free the maximum space for temporary image storage.

During the outage, watch the gateways to be sure they still have adequate space to store images.

This page is intentionally left blank.

Chapter 6 Routine Descriptions

The Food and Drug Administration classifies this software as a medical device. As such, it may not be changed in any way. Modifications to this software may result in an adulterated medical device under 21CFR820, the use of which is considered to be a violation of US Federal Statutes.

VA Policy states the following:

Those components of a national package (routines, data dictionaries, options, protocols, GUI components, etc.) that implement a controlled procedure, contain a controlled or strictly defined interface or report data to a database external to the local facility, must not be altered except by the Office of Information (OI) Technical Services (TS) staff. A controlled procedure is one that implements requirements that are mandated or governed by law or VA (Department of Veterans Affairs) directive or is subject to governing financial management standards of the Federal Government and VA or that is regulated by oversight groups such as the JCAHO or FDA. A controlled or strictly defined interface is one that adheres to a specific industry standard, will adversely affect a package and/or render the package inoperable if modified or deleted. For national software that is subject to FDA oversight, only the holder of the premarketing clearance (510(k)) is allowed to modify code for the medical device. The holder of a premarketing clearance is restricted to specifically designated TS staff that are located at the registered manufacturing site and operating in the designated production environment.

All routines, files and fields of the VistA Imaging package may not be altered except by the OI Technical Services (TS) staff. This software is regulated by the FDA and implements controlled procedures.

6.1 VistA Imaging Routines on the VistA Hospital Information System

6.1.1 Build Checksums

The Calculate and Show Checksum Values [XTSUMBLD-CHECK] menu option can be used as shown below to display a list of checksums for a specified build (KIDS file).

```
Select Programmer Options Option: CALculate and Show Checksum Values

This option determines the current Old (CHECK^XTSUMBLD) or New (CHECK1^XTSUMBLD)
logic checksum of selected routine(s).

    Select one of the following:

        1      Old
        2      New

New or Old Checksums: New// New CheckSum CHECK1^XTSUMBLD:

This option determines the current checksum of selected routine(s).
The Checksum of the routine is determined as follows:

1. Any comment line with a single semi-colon is presumed to be
   followed by comments and only the line tag will be included.

2. Line 2 will be excluded from the count.

3. The total value of the routine is determined (excluding
   exceptions noted above) by multiplying the ASCII value of each
   character by its position on the line being checked.

    Select one of the following:

        P      Package
        B      Build

Build from: Build

This will check the routines from a BUILD file.

Select BUILD NAME: MAG*3.0*118 IMAGING
MAGDCCS value = 66427733
MAGDGMRC value = 36374245
MAGDLB1 value = 55692202
MAGDLB6 value = 5964230
MAGDMEDJ value = 30422298
MAGDQR01 value = 42410638
[... intervening routines omitted.]
MAGVSTDY value = 5088717
MAGVUID value = 62918469
MAGVUID1 value = 4997448
done
```

6.1.2 Package Checksums

The Calculate and Show Checksum Values [XTSUMBLD-CHECK] menu option can be used as shown below to display a list of checksums for all routines in the Imaging Package. Imaging routines are under the MAG namespace.

```
Select Programmer Options Option: CALculate and Show Checksum Values
```

```
This option determines the current Old (CHECK^XTSUMBLD) or New (CHECK1^XTSUMBLD)
logic checksum of selected routine(s).
```

```
Select one of the following:
```

```
1      Old
2      New
```

```
New or Old Checksums: New// 2 New
New CheckSum CHECK1^XTSUMBLD:
```

```
This option determines the current checksum of selected routine(s).
The Checksum of the routine is determined as follows:
```

1. Any comment line with a single semi-colon is presumed to be followed by comments and only the line tag will be included.
2. Line 2 will be excluded from the count.
3. The total value of the routine is determined (excluding exceptions noted above) by multiplying the ASCII value of each character by its position on the line and position of the line in the routine being checked.

```
Select one of the following:
```

```
P      Package
B      Build
```

```
Build from: Package
```

```
All Routines? No => No
```

```
Routine: MAG*
Routine: <enter>
282 routines
```

```
MAG7RS  value = 54368283
MAG7RSD value = 12010159
MAG7RSO value = 6903355
MAG7RSR value = 7799977
MAG7UDR value = 7350925
MAG7UFO value = 6573900
MAG7UM  value = 23964940
MAG7UP  value = 34875703
MAGBAPI value = 74386027
MAGBAPIP value = 9049823
MAGBRTE3 value = 17206043
```

```
...
...
done
```

6.1.3 Routine Descriptions

To obtain a brief description for all VistA Imaging routines, use the First Line Routine Print [XU FIRST LINE PRINT] menu option. Including the second line in the report will show which patches have made changes to the routine. This menu option is part of Programmer Options [XUPROG] under sub-menu Routine Tools [XUPR-ROUTINE-TOOLS].

VistA Imaging routines are under the MAG namespace. The following is an example:

```
Select OPTION NAME: PROGRAMMER OPTIONS XUPROG  Programmer Options
Select Programmer Options Option: ROUTINE Tools
```

```
Select Routine Tools Option: FIRST Line Routine Print

PRINTS FIRST LINES

routine(s) ? > MAG*
searching directory ...
routine(s) ? >

(A)lpha, (D)ate, (P)atched, OR (S)ize ORDER: A//
Include line 2? NO//
DEVICE: HOME//
```

6.2 DICOM Gateway Routines

The VistA Imaging DICOM Gateway requires a number of M routines. Most of these are part of the VistA Imaging package. However, because the DICOM gateways run as standalone workstations, they must include some routines from other packages. A few routines must run in the manager UCI.

6.2.1 Checksums of VistA Imaging DICOM Gateway Routines

The following listing reflects the VistA Imaging M routines that reside on the VistA Imaging DICOM gateway system.

Routine	Checksum	Routine	Checksum	Routine	Checksum
MAG7UP	35026309	MAGDACU	9404510	MAGDAIRM	117531807
MAGBRTA4	73323436	MAGDACU0	10807003	MAGDAIRP	31922397
MAGBRTA5	74916344	MAGDACU1	38544788	MAGDAIRR	91423560
MAGBRTA6	10352181	MAGDACU2	7237662	MAGDAIRS	15785148
MAGBRTB1	26772420	MAGDACU3	8904229	MAGDAIRU	124794686
MAGBRTB2	62448973	MAGDACW1	48007177	MAGDAIRW	28060731
MAGBRTB3	21639509	MAGDACW2	26199743	MAGDAUD1	21787487
MAGBRTB4	29268889	MAGDAIR1	38225804	MAGDAUD2	11632745
MAGBRTK	20097310	MAGDAIR2	174066539	MAGDAUD3	4475591
MAGBRTL	10848658	MAGDAIR3	96391606	MAGDBB	19747360
MAGBRTPI	30941600	MAGDAIR4	110325747	MAGDBB2	44540545
MAGDACP1	74390040	MAGDAIR5	65081294	MAGDCIGL	22088679
MAGDACP2	5612621	MAGDAIR6	179937644	MAGDCIRL	14772888
MAGDACP3	46008004	MAGDAIRA	57712921	MAGDCMPE	19614608
MAGDACR1	33293963	MAGDAIRC	21720426	MAGDCST1	15269197
MAGDACR2	16258693	MAGDAIRD	93443153	MAGDCST2	11326972
MAGDACR3	55462381	MAGDAIRL	21354401	MAGDCST3	86034617

Routine	Checksum	Routine	Checksum	Routine	Checksum
MAGDCST4	37159893	MAGDHR5	3902302	MAGDIR7F	32599821
MAGDCST5	11640174	MAGDHR9	7550226	MAGDIR7G	9410773
MAGDCST6	21003965	MAGDHRC	86680704	MAGDIR7T	38613863
MAGDDEL	4367093	MAGDHRC0	7768511	MAGDIRDE	8549629
MAGDDEL1	7861418	MAGDHRC1	32850852	MAGDIW2A	17353490
MAGDDEL2	31000923	MAGDHRC2	25348186	MAGDIW3	20340399
MAGDDEL3	7544616	MAGDHRC3	127795528	MAGDIW3A	85967674
MAGDDR0	57333954	MAGDHRC4	138693297	MAGDIW3B	39882981
MAGDDR1	48401978	MAGDHRC5	109418054	MAGDIW3C	14730954
MAGDDR2	33721647	MAGDHRC6	32964204	MAGDIW4	20553707
MAGDDR2A	103732840	MAGDHRC7	19766889	MAGDIW6	33599253
MAGDDR3	55887980	MAGDHRCP	44418147	MAGDIWB0	5743080
MAGDDR7	19337667	MAGDHRCU	4706071	MAGDIWB1	82684636
MAGDDW0	18480829	MAGDIR3	32120170	MAGDIWB2	51239563
MAGDDW1	33395508	MAGDIR4A	9771049	MAGDIWB5	94186343
MAGDDW2	52939670	MAGDIR5	7586177	MAGDIWB7	16107756
MAGDDW3	37085878	MAGDIR6	88850067	MAGDIWBA	81638859
MAGDDW4	82471058	MAGDIR6A	13107192	MAGDIWBB	69921591
MAGDECHO	9429115	MAGDIR6B	21857231	MAGDIWBC	86128746
MAGDEXC1	41469390	MAGDIR6C	45366757	MAGDIWBD	30843111
MAGDEXC2	53045931	MAGDIR6D	24854094	MAGDIX	5690876
MAGDFCNS	89968928	MAGDIR6E	23447535	MAGDIX1	28030316
MAGDFND0	23608364	MAGDIR6F	22472350	MAGDLOGI	18187840
MAGDFND1	17372953	MAGDIR6G	8628791	MAGDLOGN	67846184
MAGDFND2	103160968	MAGDIR7	4535461	MAGDM2MB	16447591
MAGDFND3	108714097	MAGDIR71	67975394	MAGDMENA	55414961
MAGDFND4	46237039	MAGDIR72	4436051	MAGDMENL	7216238
MAGDFND5	11438147	MAGDIR73	5722083	MAGDMENO	39923631
MAGDFND9	5028212	MAGDIR74	6275398	MAGDMENU	51445030
MAGDGEX1	76377251	MAGDIR75	50725923	MAGDMFB	47598711
MAGDGEX2	25589452	MAGDIR7C	89687601	MAGDMFB1	85395849
MAGDGLC	36322745	MAGDIR7D	16648443	MAGDMFB2	49214267

Routine	Checksum	Routine	Checksum	Routine	Checksum
MAGDMFB3	41066270	MAGDQUE3	28047976	MAGOSFIL	37547909
MAGDMFB4	15205941	MAGDQUE4	27764385	MAGOSMSC	51783237
MAGDMFB5	25775790	MAGDRPC0	4862620	MAGOSTCP	32979219
MAGDMFB6	19405158	MAGDSSD	6477867	MAGSPID	3966944
MAGDMFB7	26178773	MAGDSTA1	68354778	MAGUE	75297995
MAGDMFB8	13147824	MAGDSTAT	52825843	MAGVCSTR	11185442
MAGDMFB9	25588255	MAGDSTRT	14101280	MAGVDGW1	14542314
MAGDMFBA	16186541	MAGDTCP	6918159		
MAGDMFBB	53824931	MAGDTCP1	69855871		
MAGDMFBC	36412183	MAGDTCP2	29403903		
MAGDMFBD	38641825	MAGDTCP3	10117098		
MAGDMFBE	86462667	MAGDTGA	5398596		
MAGDMFBI	29578964	MAGDTLOG	20351436		
MAGDMFBM	87591678	MAGDUID1	3785565		
MAGDMFBN	5306612	MAGDUID2	6700589		
MAGDMFBP	17921307	MAGDUID4	21494340		
MAGDMFBS	52098283	MAGDVRSN	3291181		
MAGDMFBT	19123785	MAGDWLKL	36028521		
MAGDMFBW	97895675	MAGDWLP2	3990165		
MAGDMFCC	25444929	MAGDWLP3	78343810		
MAGDMFIC	46728636	MAGDWLPA	69861115		
MAGDMLGV	76186792	MAGDWLPB	55436315		
MAGDMLOG	32785216	MAGDWLPC	16460081		
MAGDMMSG	53806690	MAGDWLU	4339594		
MAGDMPPC	8533330	MAGDWLU0	38702922		
MAGDMSGT	9617440	MAGDWLU1	44796296		
MAGDOS	5971106	MAGDWLU2	104897245		
MAGDQR15	17707603	MAGDWLU3	5869877		
MAGDQRU0	5735145	MAGDWLU4	59848201		
MAGDQUE0	30499869	MAGM2VC	89722252		
MAGDQUE1	32915712	MAGM2VCU	20477697		
MAGDQUE2	21951411	MAGOSDIR	28047976		

6.2.2 DICOM Gateway Routine Descriptions

The M routines on the DICOM Gateway can be listed using the FIRST ROUTINE LINE DISPLAY routine (%RFIRST). The following is an example of steps required to use the %RFIRST routine to list Imaging routines.

```
DICOM>D ^%RFIRST

Print first line of selected routines or include files.

Routine(s) : MAG*
Routine(s) :

Find routines last modified since date:
    and on or before date:

Output on
Device:    Right margin: 80=>

                First Line of Selected Routines Files
                Directory: c:\dicom\cache\

MAG7UP.INT  MAG7UP ;WOIFO/MLH - Imaging - HL7 - utilities - break out message
            into a parse tree ; 06/03/2005 12:05

MAGBRTA4.INT  MAGBRTA4 ;WOIFO/EdM - Action Queue Processor ; 12/06/2004 10:31
MAGBRTA5.INT  MAGBRTA5 ;WOIFO/EdM - Action Queue Processor ; 05/04/2007 07:56
MAGBRTA6.INT  MAGBRTA6 ;WOIFO/EdM - Action Queue Processor ; 16 Jun 2008 7:33AM
MAGBRTB1.INT  MAGBRTB1 ;WOIFO/PMK - Re-build routing rule table ; 08/26/2005 07:46
MAGBRTB2.INT  MAGBRTB2 ;WOIFO/PMK - Program #2 to build image routine master file ;
03/07/2007 09:22
MAGBRTB3.INT  MAGBRTB3 ;WOIFO/PMK - Routine to handle routing date/time functions ;
01/25/2007 09:53

--more--
```

See the previous section for the checksums of the distributed routines.

6.2.3 Kernel RPC Broker Routines

Two RPC Broker routines are incorporated into the DICOM Gateway software. See the *Vista Imaging Security Guide* for more information.

6.3 Non-M Routines Distributed as Executable Files

Executable, DLL and other supporting files, which are distributed, include capture device-specific imaging software and executable imaging software. The routine listing below is by function.

6.3.1 Clinical Workstation Files

The following tables list files installed on a Clinical (Display or Capture) workstation.

Note: Under Windows 7, some “system” files (including executable program files) may be stored in different directories than under Windows XP. Table headings below indicate only the Windows XP pathnames. Windows 7 pathnames are similar, with these changes:

Windows XP	Windows 7
C:\Program Files\...	C:\Program Files (x86)\...
C:\Windows\system32\...	C:\Windows\SystemWoW64 C:\Windows\System32

c:\windows\systemwow64 is used for 32-bit files. c:\windows\system32 is used for 64-bit files. This may sound backward, but it has to do with backward compatibility requirements. SysWoW64, standing for **Windows 32-bit on Windows 64-bit**, contains program files for 32-bit compatibility used on a 64-bit system. A Windows 7 emulator redirects calls for any “System32” files to the SysWoW64 folder.

Configuration and log file pathnames are changed as follows:

Windows XP	Windows 7
C:\Documents and Settings\All Users\Application Data\Vista\Imaging\mag.ini (TeleReader)	C:\ProgramData\Vista\Imaging\mag.ini (TeleReader)
C:\Documents and Settings\All Users\Application Data\Vista\Imaging\mag308.ini (Clinical Display and Clinical Capture)	C:\ProgramData\Vista\Imaging\mag308.ini (Clinical Display and Clinical Capture)
C:\Documents and Settings\All Users\Application Data\Vista\Imaging\MagTeleReaderConfig.ini	C:\ProgramData\Vista\Imaging\MagTeleReaderConfig.ini
C:\Documents and Settings\All Users\Application Data\Vista\Imaging\Log\MagTeleReaderConfig10042012034524PM.log*	C:\ProgramData\Vista\Imaging\Log\MagTeleReaderConfig10042012034524PM.log*

*The name of the log file is based on MagTeleReaderConfig + date time stamp.

The following tables list files installed on a Clinical (Display or Capture) workstation.

Clinical Display & Capture files		
Windows XP 32-bit -- C:\Program Files\Vista\Imaging		
Windows 7 64-bit -- C:\Program Files(x86)\Vista\Imaging		
ABSTRTGA.EXE	HSUMM.TXT	MagScanFilm.EXE
ActiveMILDefault.exe	ImagDEMO.DAT	MagSCREEN.HLP
Annotation Editor Help.cnt	mag308.ini*	Magsys.cnt
ANNOTATION EDITOR HELP.HLP	MagDemos.TXTMagEKGView.hlp	MAGSYS.EXE
demo12.txtDEMO1802.TXT	MagImageCapture.exe	Magsys.hlp
DEMO2230.TXT	MAGIMAGEDeLETE.HLP	MAGSYS.ini
demo3.txt	MagImageDisplay.exe	MagSysKey.CNT
DEMO446.TXT	magIniPermissions.bat	MAGSYSKEY.HLP
demolist.txt	MagMinibld.EXE	MagTeleReader.exe
DocScan.cnt	magPermissions.bat	MagTeleReaderConfig.exe
DOCSAN.HLP	MagScan150N.BAT	magupdate.ini
ERRLOOK.EXE	MagScan75N.BAT	magwrks.CNT
ERRLOOK.HLP	MagScanFile.EXE	MAGWRKS.EXE
FRAMGRAB.EXE		Magwrks.hlp
		MEANSTEST.HLP
		SCNAPI.DLL
<p><i>The main application files are shown in bold.</i></p> <p><i>Files ending in '.cnt' and '.hlp' are contents for help files and help files.</i></p>		

Icons used by Clinical Display & Capture		
Windows XP 32-bit -- C:\Program Files\Vista\Imaging		
Windows 7 64-bit -- C:\Program Files(x86)\Vista\Imaging		
abscine.bmp	DoD_PDF.bmp	magrtf.bmp
absekg.bmp	DoD_PDF.psd	magtext.bmp
ABSERROR.BMP	DoD_RTF.bmp	magwav.bmp
absjbox.bmp	DoD_RTF.psd	MotionVideo.bmp
abspacg.bmp	DoD_Unavailable.bmp	Magblack.bmp
abspaci.bmp	DoD_Unavailable.psd	magdoc.bmp
absremote.bmp	DoD_Word.bmp	maghtml.bmp
AnnotPencilSmall.bmp	DoD_Word.psd	magpdf.bmp
AnnotReadOnly.bmp	downarrow1.bmp	magsensitive.bmp
AnnotReadOnly.psd	ImageQA.bmp	magtext.bmp

Icons used by Clinical Display & Capture		
Windows XP 32-bit -- C:\Program Files\VistA\Imaging		
Windows 7 64-bit -- C:\Program Files(x86)\VistA\Imaging		
BLANK2.bmp	InternalError.bmp	magwav.bmp
BLANK.BMP	FileOpenError.bmp	MotionVideo.bmp
Blank.tga	FullResFileNotFound.bmp	MotionVideoAbs.bmp
CAPTURE.BMP	FullResFileOpenError.bmp	NOTEXIST.BMP
DoD_ASCII.bmp	ImageUnavailable.bmp	PRECAP.BMP
DoD_ASCII.psd	jboffln.abs	magBlockedImage.bmp
DoD_Doc.bmp	JBOFFLN.bmp	magsensitive.bmp
DoD_Doc.psd	JBOFFLN.tga	uparrow1.bmp
DoD_JPG.bmp	magavi.bmp	
DoD_JPG.psd	magBlockedImage.bmp	
DoD_NCAT.bmp	magDeletedGroup.bmp	
DoD_NCAT.psd	magDeletedImage.bmp	

Sample images (obsolete)		
Windows XP 32-bit -- C:\Program Files\VistA\Imaging\Image		
Windows 7 64-bit -- C:\Program Files(x86)\VistA\Imaging\Image		
<i>These files are no longer distributed as of Patch 8, but may be present on older workstations. These files are no longer used.</i>		
BLACKBOX.TGA	DILB3.BMP	Samples.txt

XP 32-bit -- C:\Program Files\VistA\Imaging\Help\Client
Windows 7 64-bit -- C:\Program Files(x86)\VistA\Imaging\ Help\Client
<i>All files in this directory are help files for the VistA Imaging Display and Capture clients.</i>

Windows XP 32-bit -- C:\Program Files\VistA\Imaging\Lib		
Windows 7 64-bit -- C:\Program Files(x86)\VistA\Imaging\Lib		
ACE.dll	GEAR32PO.OCX	igMED15a.ocx
AGM.dll	ig_cmyk_profile.icm	igmed15d.dll
BIB.dll	ig_rgb_profile.icm	igmed32s.dll

Windows XP 32-bit -- C:\Program Files\Vista\Imaging\Lib		
Windows 7 64-bit -- C:\Program Files(x86)\Vista\Imaging\Lib		
BIBUtils.dll	igART15a.ocx	IGMed32x.ocx
DL70ACE.dll	igartgui15d.dll	igmult15d.dll
DL70AdobeXMP.dll	igCORE15a.ocx	igMULTIMEDIA15a.ocx
DL70AGM.dll	igCORE15d.dll	igPDF15a.ocx
DL70ARE.dll	igDISPLAY15a.ocx	igPROCESSING15a.ocx
DL70AXE8SharedExpat.dll	igDLGS15a.ocx	igVECT15a.ocx
DL70AXE16SharedExpat.dll	igEFFECTS15a.ocx	igVIEW15a.ocx
DL70BIB.dll	igFORMATS15a.ocx	JP2KLib.dll
DL70BIBUtils.dll	igguidlg15a.dll	kdu_v52R.dll
DL70CoolType.dll	igguiwin15a.dll	MagAnnOCX.ocx
DL70JP2KLib.dll	igJPEG2K15a.ocx	MagAnnTool.dllInserver.dll
DL70PDFL.dll	igLZW15a.ocx	SliceCalc.dll
		XRefUtils.dll

Windows XP 32-bit -- C:\Program Files\Vista\Imaging\ Lib\Accusoft16.2		
Windows 7 64-bit -- C:\Program Files(x86)\Vista\Imaging\ Lib\Accusoft16.2		
ACE.dll	ig_cmyk_profile.icm	igMED16a.ocxigMULTIMEDIA16
AGM.dll	ig_rgb_profile.icm	a.ocx
BIB.dll	igART16a.ocx	igPDF16a.ocxigPROCESSING16a.
BIBUtils.dll	igartgui16d.dll	ocx
DL81ACE.dll	igArtX16a.ocx	igtwain16a.ocx
DL81AdobeXMP.dll	igArtX16d.dll	igtwain16d.dll
DL81AGM.dll	IGArtXGUI16a.ocx	igVECT16a.ocxigVIEW16a.ocx
DL81ARE.dll	igArtXGUI16d.dll	JP2KLib.dll
DL81AXE8SharedExpa t.dll	igCORE16a.ocxigDISPLAY16 a.ocx	kdu_v52R.dll
DL81BIB.dll	igDLGS16a.ocx	mfc71.dll
DL81BIBUtils.dll	igEFFECTS16a.ocx	msvcp71.dll
DL81CoolType.dll	igFORMATS16a.ocx	msvcr71.dll
DL81JP2KLib.dll	igguidlg16a.ocx	nserver.dll
DL81PDFL.dll	igguidlg16a.dll	
	igguiwin16a.dll	
	igJBIG216a.ocx	
	igJBIG216d.dll	
	igJPEG2K16a.ocx	
	igjpeg2k16d.dll	
	igLZW16a.ocx	
	iglw16d.dll	

PDF support files		
Windows XP 32-bit -- C:\Program Files\Vista\Imaging\ Lib\Resource\PDF\CMap		
Windows 7 64-bit -- C:\Program Files(x86)\Vista\Imaging\ Lib\Resource\PDF\CMap		
78-EUC-H	B5pc-H	KSCms-UHC-H
78-EUC-V	B5pc-UCS2	KSCms-UHC-HW-H
78-H	B5pc-UCS2C	KSCms-UHC-HW-V
78-RKSJ-H	B5pc-V	KSCms-UHC-UCS2
78-RKSJ-V	CNS-EUC-H	KSCms-UHC-V
78-V	CNS-EUC-V	KSCpc-EUC-H
78ms-RKSJ-H	CNS1-H	KSCpc-EUC-UCS2
78ms-RKSJ-V	CNS1-V	KSCpc-EUC-UCS2C
83pv-RKSJ-H	CNS2-H	KSCpc-EUC-V
90ms-RKSJ-H	CNS2-V	NWP-H
90ms-RKSJ-UCS2	ETen-B5-H	NWP-V
90ms-RKSJ-V	ETen-B5-UCS2	RKSJ-H
90msp-RKSJ-H	ETen-B5-V	RKSJ-V
90msp-RKSJ-V	ETenms-B5-H	Roman
90pv-RKSJ-H	ETenms-B5-V	UCS2-90ms-RKSJ
90pv-RKSJ-UCS2	ETHK-B5-H	UCS2-90pv-RKSJ
90pv-RKSJ-UCS2C	ETHK-B5-V	UCS2-B5pc
90pv-RKSJ-V	EUC-H	UCS2-ETen-B5
Add-H	EUC-V	UCS2-GBK-EUC
Add-RKSJ-H	Ext-H	UCS2-GBpc-EUC
Add-RKSJ-V	Ext-RKSJ-H	UCS2-KSCms-UHC
Add-V	Ext-RKSJ-V	UCS2-KSCpc-EUC
Adobe-CNS1-0	Ext-V	UniCNS-UCS2-H
Adobe-CNS1-1	GB-EUC-H	UniCNS-UCS2-V
Adobe-CNS1-2	GB-EUC-V	UniCNS-UTF16-H
Adobe-CNS1-3	GB-H	UniCNS-UTF16-V
Adobe-CNS1-4	GB-V	UniCNS-UTF32-H
Adobe-CNS1-B5pc	GBK-EUC-H	UniCNS-UTF32-V
Adobe-CNS1-ETen-B5	GBK-EUC-UCS2	UniCNS-UTF8-H
Adobe-CNS1-H-CID	GBK-EUC-V	UniCNS-UTF8-V
Adobe-CNS1-H-Host	GBK2K-H	UniGB-UCS2-H
Adobe-CNS1-H-Mac	GBK2K-V	UniGB-UCS2-V
Adobe-CNS1-UCS2	GBKp-EUC-H	UniGB-UTF16-H
Adobe-GB1-0	GBKp-EUC-V	UniGB-UTF16-V
Adobe-GB1-1	GBpc-EUC-H	UniGB-UTF32-H
Adobe-GB1-2	GBpc-EUC-UCS2	UniGB-UTF32-V
Adobe-GB1-3	GBpc-EUC-UCS2C	UniGB-UTF8-H
Adobe-GB1-4	GBpc-EUC-V	UniGB-UTF8-V
Adobe-GB1-GBK-EUC	GBT-EUC-H	UniHojo-UCS2-H
Adobe-GB1-GBpc-EUC	GBT-EUC-V	UniHojo-UCS2-V
Adobe-GB1-H-CID	GBT-H	UniHojo-UTF16-H
Adobe-GB1-H-Host	GBT-V	UniHojo-UTF16-V

PDF support files		
Windows XP 32-bit -- C:\Program Files\Vista\Imaging\ Lib\Resource\PDF\CMap		
Windows 7 64-bit -- C:\Program Files(x86)\Vista\Imaging\ Lib\Resource\PDF\CMap		
Adobe-GB1-H-Mac	GBTpc-EUC-H	UniHojo-UTF32-H
Adobe-GB1-UCS2	GBTpc-EUC-V	UniHojo-UTF32-V
Adobe-Japan1-0	H	UniHojo-UTF8-H
Adobe-Japan1-1	Hankaku	UniHojo-UTF8-V
Adobe-Japan1-2	Hiragana	UniJIS-UCS2-H
Adobe-Japan1-3	HKdla-B5-H	UniJIS-UCS2-HW-H
Adobe-Japan1-4	HKdla-B5-V	UniJIS-UCS2-HW-V
Adobe-Japan1-5	HKdlb-B5-H	UniJIS-UCS2-V
Adobe-Japan1-6	HKdlb-B5-V	UniJIS-UTF16-H
Adobe-Japan1-90ms-RKSJ	HKgccs-B5-H	UniJIS-UTF16-V
Adobe-Japan1-90pv-RKSJ	HKgccs-B5-V	UniJIS-UTF32-H
Adobe-Japan1-H-CID	HKm314-B5-H	UniJIS-UTF32-V
Adobe-Japan1-H-Host	HKm314-B5-V	UniJIS-UTF8-H
Adobe-Japan1-H-Mac	HKm471-B5-H	UniJIS-UTF8-V
Adobe-Japan1-PS-H	HKm471-B5-V	UniJISPro-UCS2-HW-V
Adobe-Japan1-PS-V	HKscs-B5-H	UniJISPro-UCS2-V
Adobe-Japan1-UCS2	HKscs-B5-V	UniJISPro-UTF8-V
Adobe-Japan2-0	Hojo-EUC-H	UniJISX0213-UTF32-H
Adobe-Korea1-0	Hojo-EUC-V	UniJISX0213-UTF32-V
Adobe-Korea1-1	Hojo-H	UniKS-UCS2-H
Adobe-Korea1-2	Hojo-V	UniKS-UCS2-V
Adobe-Korea1-H-CID	Identity-H	UniKS-UTF16-H
Adobe-Korea1-H-Host	Identity-V	UniKS-UTF16-V
Adobe-Korea1-H-Mac	Katakana	UniKS-UTF32-H
Adobe-Korea1-KSCms-UHC	KSC-EUC-H	UniKS-UTF32-V
Adobe-Korea1-KSCpc-EUC	KSC-EUC-V	UniKS-UTF8-H
Adobe-Korea1-UCS2	KSC-H	UniKS-UTF8-V
AdobeFnt09.lst	KSC-Johab-H	V
B5-H	KSC-Johab-V	vssver2.scc
B5-V	KSC-V	WP-Symbol

PDF support files		
Windows XP 32-bit -- C:\Program Files\Vista\Imaging\ Lib\Resource\PDF\Font		
Windows 7 64-bit -- C:\Program Files(x86)\Vista\Imaging\ Lib\Resource\PDF\Font		
AdobeFnt09.lst	zx_____.mmm	zy_____.mmm
vssver2.scc		

MUSE API support files		
Windows XP 32-bit -- C:\Program Files\VistA\Imaging\Muse		
Windows 7 64-bit -- C:\Program Files(x86)\VistA\Imaging\Muse		
Bti.ini	lfmac80n.dll	LTKRN80N.DLL
BUTIL.EXE	lfmac80w.dll	LTKRN80W.DLL
ccalc32.dll	lfmsp80n.dll	LTTHK80W.DLL
DCMUTL32.DLL	lfmsp80w.dll	LTTWN80N.DLL
lfavi80n.dll	lfpcd80n.dll	LTTWN80W.DLL
lfavi80w.dll	lfpcd80w.dll	LTWND80N.DLL
lfawd80n.dll	lfpct80n.dll	LTWND80W.DLL
lfbmp80n.dll	lfpct80w.dll	museapi.dll
lfbmp80w.dll	lfpcx80n.dll	museapi5a.dll
lfc80n.dll	lfpcx80w.dll	MUSEAPI5e.dll
lfc80w.dll	lfpng80n.dll	MUSEAPI7.dll
lfcmp80n.dll	lfpng80w.dll	museapiFAKE.dll (for non-MUSE sites)
lfcmp80w.dll	lfras80n.dll	NWLOCALE.DLL
lfdic80n.dll	lfras80w.dll	PRINTLIB.DLL
lfdic80w.dll	lftga80n.dll	Tabctl32.ocx
lfeps80n.dll	lftga80w.dll	table32.dll
lfeps80w.dll	lftif80n.dll	W3AIF103.DLL
lffax80n.dll	lftif80w.dll	W3BIF106.DLL
lffax80w.dll	lffwx80n.dll	W3BTRV7.DLL
lffpx7.dll	lffwx80w.dll	W3CRS106.DLL
lffpx80n.dll	lffwmf80n.dll	W3MIF109.DLL
lfgif80n.dll	lffwmf80w.dll	W3NSL105.DLL
lfgif80w.dll	lffwpg80n.dll	W3NSR103.DLL
lfica80n.dll	lffwpg80w.dll	W3SCMV7.DLL
lfica80w.dll	LTANN80N.DLL	W3UPI104.DLL
lfimg80n.dll	LTANN80W.DLL	WBEXEC.EXE
lfimg80w.dll	LTEFX80N.DLL	WBTRCALL.DLL
lfkodak.dll	LTEFX80W.DLL	WBTRV32.DLL
lflma80n.dll	LTFIL80N.DLL	wcalc32.dll
lflma80w.dll	LTFIL80W.DLL	zlib32.dll
lflmb80n.dll	LTIMG80N.DLL	
lflmb80w.dll	LTIMG80W.DLL	

Annotation Editor support files - AccuSoft OCX files		
Windows XP 32-bit -- C:\windows\system32		
Windows 7 64-bit -- C:\windows\SysWoW64		
igmed32s.dll IGMed32x.ocx imgadmin.ocx imgcmn.dll imgedit.ocx imgscan.ocx imgshl.dll	imgthumb.ocx jpeg1x32.dll jpeg2x32.dll oieng400.dll oiprt400.dll oislb400.dll	oissq400.dll oitwa400.dll oiui400.dll tiff1t.dll xiffr3_0.dll

Display CDA Stylesheet support files -		
Windows XP 32-bit -- C:\Program Files\Vista\Imaging\stylesheets		
Windows 7 64-bit -- C:\Program Files (x86)\Vista\Imaging\stylesheets		
CDA.xsl		

Configuration File MAG.ini	
Windows XP 32-bit	C:\Documents and Settings\All Users\Application Data\Vista\Imaging\MAG.ini
Windows 7 64-bit	C:\ProgramData\Vista\Imaging\MAG.ini

Note: The directories in which some “system” files (including executable program files) are stored depend on the operating system on which the software is installed and on whether it is installed on a 32-bit computer or on a 64-bit computer. The following table lists the paths for the currently supported platforms.

Windows XP 32-bit	Windows 7 64-bit
C:\Program Files\...	C:\Program Files (x86)\...
C:\Windows\system32\...	C:\Windows\SysWoW64

Configuration and log file pathnames are changed as follows:

Windows XP	Windows 7
C:\Documents and Settings\All Users\Application Data\Vista\Imaging\mag.ini (TeleReader)	C:\ProgramData\Vista\Imaging\mag.ini (TeleReader)
C:\Documents and Settings\All Users\Application Data\Vista\Imaging\mag308.ini (Clinical Display and Clinical Capture)	C:\ProgramData\Vista\Imaging\mag308.ini (Clinical Display and Clinical Capture)
C:\Documents and Settings\All Users\Application Data\Vista\Imaging\MagTeleReaderConfig.ini	C:\ProgramData\Vista\Imaging\MagTeleReaderConfig.ini
C:\Documents and Settings\All Users\Application Data\Vista\Imaging\Log\MagTeleReaderConfig10042012034524PM.log*	C:\ProgramData\Vista\Imaging\Log\MagTeleReaderConfig10042012034524PM.log*

*The name of the log file is based on MagTeleReaderConfig + date time stamp.

6.3.2 Background Processor Files

File Name	Description
GEAR32PO.OCX	Used by mag_makeabs.exe to create derivative files.
igmed32s.dll	Used by mag_makeabs.exe to create derivative files.
IGMed32x.ocx	Used by mag_makeabs.exe to create derivative files.
MagImportXControl1.ocx	Import API Active X control file used by the Background Processor.
mag_makeabs.exe	Creates derivative files
Magbtm.exe	Processes queues and configures imaging system files.
MagHTMLARchive.exe	Creates HTML output log files
MagVerifier.exe	Performs database integrity checks.

File Name	Description
MagPurge.exe	Removes old image files and recovers image files on VistA Imaging shares.

6.3.3 Online Help Files

Online help files are installed with the Clinical Workstation, Background Processor (BP), and VistARad software.

All three of the BP applications are documented in MAG_BPUserman.htm and the contents of the MAG_BPUserman_files subdirectory. The MAG_BP_User_Manual.PDF can also be found in the application subdirectory and can be accessed from the Help menu of the BP Queue Processor main window.

The clinical workstation help system is located in the C:\Program Files\VistA\Imaging\Help\Client\index.htm subdirectory. If the workstation is using the Windows 7 (64 bit) operating system, a separate help file for TeleReader is located in C:\Program Files(x86)\VistA\Imaging\Help\TeleReader. The file name is MAGTeleReaderConfig.pdf.

6.3.4 DICOM Gateway Files

The following tables list files that are part of a DICOM Gateway installation. Files are grouped by folder.

C:\Program Files\VistA\Imaging\DICOM – Primary program files	
File Name	Description
BATCH_SEND_IMAGE.BAT	Batch file that takes a folder of DICOM objects and sends them to a storage provider.
CTN_VERSION.EXE	Program that prints the current installed version of the Central Test Node software.
DCF_LicenseInstaller.bat	Program that installs the DCF Toolkit license.
DCM_DIFF.EXE	Program that compares two DICOM files.
DCM_DUMP_ELEMENT.EXE	Program that dumps the content of a DICOM tag into a DICOM file.
DCM_DUMP_FILE.EXE	Program that dumps the content of a DICOM file.
DICOM_ECHO.EXE	Program that can be used to test network connectivity with DICOM modalities.

C:\Program Files\Vista\Imaging\DICOM – Primary program files	
File Name	Description
DRIVES.EXE	Program that provides information on currently mounted disk drives.
ERRLOOK.EXE	Program that can be used to display the meaning of an MS-Windows error code.
MAG_AbstrTGA.EXE	Program that creates thumbnails of images.
MAG_COMPRESSOR_AWARE.EXE	Program to compress image files before transmission.
MAG_CSTORE.EXE	Program that runs on the DICOM Gateway to store images.
MAG_DCM_COPY.EXE	Program that copies parts of DICOM files (used for modifying information in image headers).
MAG_DCMABSTRACT.EXE	Program that creates abstracts (thumbnails of images) from DICOM objects.
MAG_DCMTOTGA.EXE	Program that converts DICOM images to Targa Images.
MAG_DCM_COPY.EXE	Program that copies parts of DICOM files (used for modifying information in image headers).
MAG_MAKELINK.EXE	Program to create icons.
MAG_RECON.EXE	Program to reconstruct a DICOM File from an existing DICOM file and a script file containing header-information.
MAG_RECON.TXT	Sample script file to be used with MAG_Recon.exe.
MAG_TELNET.CNT	Table of contents for Help file.
MAG_TELNET.EXE	Help file for Telnet client application.
MAG_TELNET.HLP	Telnet client application.
MAG_TGATODCM.EXE	Program that converts Targa images to DICOM images.

C:\Program Files\Vista\Imaging\DICOM – Primary program files	
File Name	Description
MAG_VISTA_SEND_IMAGE.EXE	Program that transmits image files.
MSVCR71.DLL	Support library for executables compiled with Microsoft C Compiler.
OD.EXE	Program that produces octal dumps of binary files.
PATHMAN.EXE	Program that manipulates the default “path” lookup string.
SEND_IMAGE.EXE	Program that transmits image files.
SLEEP.EXE	Program that allows a batch file to “wait” for a couple of seconds.



C:\Program Files\Vista\Imaging\DCMView – DICOM Viewer program files	
File Name	Description
MAG_DCMVIEW.EXE	DICOM image viewer: Program to display DICOM images.
VIEWER1.ICO	Icon for MAG_DCMView.exe program.

C:\Program Files\Vista\Imaging\CVixInstaller – CVIX installer files
This folder and its subfolders contain the files for the CVIX installer. They should not be modified or deleted.

C:\Program Files\Vista\Imaging\HDIGInstaller – HDIG installer files
This folder and its subfolders contain the files for the HDIG installer. They should not be modified or deleted.

C:\Program Files\VistA\Imaging\VIXInstaller – VIX installer files
This folder and its subfolders contain the files for the VIX installer. They should not be modified or deleted.

C:\Program Files\VistA\Imaging\MAG_MakeAbs – Abstract generator files	
File Name	Description
MAG_DCMABSTRACT.ICO	Icon for MAG_DCMabstract.exe.
README.TXT	File, which provides status information about the Abstract Maker installation,

C:\DICOM – Icon files	
File Name	Sample
MAGCSTORE.ICO	
MAGVISTA.ICO	

C:\DICOM\Abstract – Files used for generic abstracts for certain image types	
File Name	Description
CANNED_IMAGE.JPG	Canned abstract for JPEG files.
MAG_CANNED_ECG.BMP	Canned abstract for ECG files.
MAG_CANNED_PDF.BMP	Canned abstract for PDF files.
MAG_WHATEVER.BMP	Canned abstract for other types of files that cannot have abstracts generated “on the fly”.

C:\DICOM\Cache – Caché database folder	
File Name	Description
CACHE.DAT	Program that has the Caché database for DICOM Gateways.
CSTORE.OUT	Startup log file produced by backend M server for the MAG_CSTORE.EXE front end storage provider processes.
WORKLIST_60010.OUT	Startup log file produced by backend M server for the Modality Worklist provider processes.

C:\DICOM\Data1 – Text data folder; additional Data2, Data3, folders may exist <i>May be stored in other local drives on older systems</i>	
File Name	Description
INIT_DICOM.BAT	Program that re-initializes the subdirectories of the directory in which the BAT file is stored.
SEARCH.BAT	Program that scans .TXT files for the occurrence of a specified string.

<drive>:\DICOM\Dict – Dictionary files, typically stored in a network folder	
File Name	Description
AE_TITLE.DIC	Dictionary file that maps DICOM Application Entity Titles to well-known aliases and provides descriptions.
AE_TITLE.SAMPLE	Distributed initial version of AE_TITLE.DIC file.
CT_PARAM.DIC	Table containing prior settings for conversion parameters. Imported by ^MAGDMFB7.
DATA_CR.DIC	Additional data fields to be displayed on DICOM Gateway. Imported by ^MAGDIR4.
DATA_MRI.DIC	Additional data fields to be displayed on DICOM Gateway. Imported by ^MAGDIR4.

<drive>:\DICOM\Dict – Dictionary files, typically stored in a network folder	
File Name	Description
DATAGECT.DIC	Additional data fields to be displayed on DICOM Gateway (General Electric). Imported by ^MAGDIR4.
DATAMISC.DIC	Additional data fields to be displayed on DICOM Gateway. Imported by ^MAGDIR4.
ELEMENT.DIC	DICOM Element dictionary. Imported by ^MAGDMFB2.
HL7.DIC	VistA HL7 dictionary. Imported by ^MAGDMFB7.
INSTRUMENT.DIC	List of image producing instruments, distributed as Instrument.Sample. Imported by ^MAGDMFB8
INSTRUMENT.SAMPLE	Distributed initial version of INSTRUMENT.DIC.
MODALITY.DIC	Image processing rules for modalities. Imported by ^MAGDMFB8.
MODALITY.SAMPLE	Distributed initial version of MODALITY.DIC.
PORTLIST.DIC	Locally edited list of network ports for DICOM services. Imported by ^MAGDMFB9.
PORTLIST.SAMPLE	Distributed initial version of PORTLIST.DIC.
ROUTE.DIC	Locally edited list of image processing rules for automatic routing. Imported by ^MAGBTRB1.
ROUTE.SAMPLE	Distributed initial version of ROUTE.DIC.
SCP_LIST.DIC	Provider application parameters. Imported by ^MAGDMFB9.
SCU_LIST.DIC	List of Service Class User Applications, distributed as SCU_List.Sample. Imported by ^MAGDMFB9.
TEMPLATE.DIC	Macros for event message templates. Imported by ^MAGDMFB3.
TEMPLATE.TMP	Temporary file created when loading the TEMPLATE.dic dictionary.
UID.DIC	UID dictionary. Imported by ^MAGDMFB4.

<drive>:\DICOM\Dict – Dictionary files, typically stored in a network folder	
File Name	Description
WORKLIST.DIC	Locally edited list of the modality Called Application Entity Titles and the corresponding DICOM Modality Worklist database attributes. Imported by ^MAGDMFB8.
WORKLIST.SAMPLE	Distributed initial version of WORKLIST.DIC.

C:\DICOM\Web – Contains temporary files that are used in the installation process.	
File Name	Description
MAGDICOM.SETUP.CSP	Temporary file used in the installation process.
MAGDICOM.STATUS.CSP	Temporary file used in the installation process.
MAGLOGO1.GIF	Temporary file used in the installation process.
MAGLOGO2.GIF	Temporary file used in the installation process.
MAGMASTERFILE.CSP	Temporary file used in the installation process.
VABKG.JPG	Temporary file used in the installation process.

6.3.4.1 Sample Files

For the purpose of testing that the software is properly installed, a number of sample files are included in the distribution kit.

6.3.4.1.1 Sample DICOM Images

The sample images that are available for the DICOM gateway can be used to perform trial image transmissions.

File	Description
BabyFace.dcm	Ultrasound image (640x480 pixels)
BoneScrw.dcm	CR image (2048x2577 pixels)
Carotid.dcm	Ultrasound image (640x480 pixels)
EyeCLens.dcm	(640x560 pixels)

File	Description
EyeClot.dcm	(640x560 pixels)
EyeLens.dcm	(640x560 pixels)
EyeSttch.dcm	(640x560 pixels)
Fillings.dcm	IO image (811x644 pixels)
GoldGate.dcm	Picture of the Golden Gate Bridge in San Francisco, labeled as modality type OT (other) (640x480 pixels).
Implant.dcm	IO image (811x644 pixels)
PaceMkr.dcm	CR image (1716x1910 pixels)
Retina.dcm	(640x480 pixels)
Roots.dcm	IO image (811x644 pixels)
Skull.dcm	CR mage (2048x2577 pixels)
Spine.dcm	CR image (2048x2495 pixels)
test.txt_new	Sample command file, used for modifying information in image headers.

6.3.4.1.2 Sample HL7 Data Streams

The following sample HL7 streams are available.

File	Description
Baltimore.gbl	Small data set
Boston.gbl	Large data set

6.3.5 VistARad Workstation Files

Files that are installed on a VistARad workstation are listed below. Files are grouped by folder.

Note—the folder locations are different for Windows 7 and Windows XP. Each of the respective folder locations are noted for each of the files listed below.

Windows 7 – C:\Users\Public\Desktop

Windows XP – C:\Documents and Settings\All Users\Desktop

File	Description
MAG_VistARad_Patch133	desktop shortcut

Windows 7 – C:\ProgramData\Microsoft\Windows\Start Menu\Programs\VistA Imaging Programs

Windows XP – C:\Documents and Settings\All Users\Start Menu\Programs\VistA Imaging Programs

File	Description
MAG_VistARad_Patch133	start menu shortcut

Windows 7 – C:\Program Files (x86)\Vista\Imaging\MAG_VistARad

Windows XP – C:\Program Files\Vista\Imaging\MAG_VistARad

File	Description
Bapi32_65_5.dll	DLL for Broker ActiveX control; As part of the Vista Imaging SSOi effort, we will be upgrading this library and BDK, (expected version XWB*1.1*65 currently in development and beta testing), which has built-in integration to the IAM SSOi Secure Token Server (STS) authentication model including PIV/PIN prompt(s).
CCMBroker.dll	core DLL
DimFileX.ocx	DLL for Dome ActiveX control
Dimpl8.dll	DLL for Dome ActiveX control
DimplX.ocx	DLL for Dome ActiveX control
DXShared.dll	DLL for Dome ActiveX control
FreeImage.dll	DLL for image processing
Launcher.exe	utility executable to support monitored site auto-login function
LayoutSelect.dll	VistARad core functionality DLL (core DLL)
MAG_Vistarad.exe	VistARad main executable file
MAG_Vistarad_Util.exe	VistARad teaching file support executable
RPCBrokerCom.dll	DLL for Broker ActiveX control
RpcDbAccessCom.dll	core DLL
SliceCalc.dll	core DLL
TargaFile.dll	core DLL

File	Description
VA_CaseManager.dll	core DLL
VA_DelphiUtils.dll	DLL for password decryption to gain access to image share
VA_DICOM.dll	DLL for accessing DICOM files
VA_DxShared.dll	core DLL
VA_GridCtrl.dll	core DLL
VA_HPModule.dll	core DLL
VA_ImgLdrCtrl.dll	core DLL
VA_Manager.dll	core DLL
VA_Shared.dll	core DLL
VA_StackViewCtrl.dll	core DLL
VA_TeachingFiles.dll	core DLL
VA_Vistarad.dll	core DLL
VergenceContextor.dll	DLL to support context management
VIXBroker.dll	DLL for VistA Imaging Exchange broker

Windows 7 – C:\Program Files (x86)\Vista\Imaging\MAG_VistARad\Help

Windows XP – C:\Program Files\Vista\Imaging\MAG_VistARad\Help

File	Description
MAG_VistARad_User_Guide.pdf	VistARad help--user guide
MAG_vrad_QSG.pdf	VistARad help--quick start guide
MAG_Vrad_Quick_Ref.pdf	VistARad help--quick reference card
MAG_vrad_Shortcuts.pdf	VistARad help--keyboard shortcuts

Windows 7 – C:\ProgramData\Vista\Imaging\MAG_VistARad\Log

Windows XP – C:\Documents and Settings\All Users\Application Data\Vista\Imaging\MAG_VistARad\Log

File	Description
MAG_VistARad_mmddyyyy_hhmmss_Lognnn.txt	VistARad log files

Windows 7 – C:\ProgramData\Vista\Imaging\MAG_VistARad\Config

Windows XP – C:\Documents and Settings\All Users\Application Data\Vista\Imaging\MAG_VistARad\Config

File	Description
HPConfig.xml	used for internal reference
MAG_Dicom_Attributes.lst	used for internal reference
Mag_DicomTags.txt	used for internal reference
MAG_Special_Attributes.lst	used for internal reference
Mag_statusdatasettings.txt	used for internal reference
MAGJ.ini	VistARad settings

File	Description
modality.txt	used for internal reference
radlextree.xml	internally used for Teaching Files feature
template.dcm	internally used to create DICOM files

Redistributable packages for necessary runtimes (typically installed in **C:\WINDOWS\system32** and/or **C:\WINDOWS\WinSxS**)

Microsoft OLE 2.40 for Windows NT(TM) and Windows 95(TM) Operating Systems
Visual C++ 8.0 ATL (x86) WinSXS MSM
Visual C++ 8.0 CRT (x86) WinSXS MSM
Visual C++ 8.0 MFC.Policy (x86) WinSXS MSM
Visual C++ 8.0 MFC (x86) WinSXS MSM
Microsoft GDI+
Microsoft Visual C++ 2005 SP1 Redistributable Package MFC Update (x86)
Windows Installer 3.1 (x86)

6.3.6 MAG_Decompressor Files

The following files are installed only on systems that are recipients of routed files that use compression. For more information, refer to the *Routing User Guide*.

Mag_Decompressor files are installed in: C:\Program Files\VistA\Imaging\MAG_Decompressor
 awj2k.dll (not distributed by VistA Imaging; purchased from Aware Inc.)
 MAG_Decompressor.exe (distributed by Imaging)

6.3.7 Storage Site Utilities

The following are maintenance utilities:

- MagUtility used for various maintenance tasks related to Tier 1, database, and Tier 2
- MagDexter used to provide jukebox platter reports for use with the new MagKat utility
- MagKat, a database maintenance tool used to backfill specific fields in the IMAGE file (#2005).

For details, see the *Storage Utilities User Manual*.

6.3.8 VIX Files

For a list of the files installed for the VIX (Vista Imaging Exchange) service, see the VIX Reference chapter in the *VIX Administrator's Guide*.

6.3.9 DICOM Importer II Client Files

The following files are installed on workstations on which the DICOM Importer II client is installed:

- **..\logs\log.txt**
- **Dicom.dll**
- **DicomImporter.Common.dll**
- **DicomImporter.DataSources.dll**
- **DICOMImporter.unity.config**
- **DicomImporter.ViewModels.dll**
- **DicomImporter.Views.dll**
- **ImagingClient.Infrastructure.dll**
- **ImagingShell.exe**
- **ImagingShell.exe.config**
- **log4net.dll**
- **log4net.xml**
- **MAG_DICOM_Importer_II_User_Manual.pdf**
- **Microsoft.Net.Http.dll**
- **Microsoft.Practices.Prism.dll**
- **Microsoft.Practices.Prism.Interactivity.dll**
- **Microsoft.Practices.Prism.Interactivity.xml**
- **Microsoft.Practices.Prism.MefExtensions.dll**
- **Microsoft.Practices.Prism.MefExtensions.xml**
- **Microsoft.Practices.Prism.UnityExtensions.dll**
- **Microsoft.Practices.Prism.UnityExtensions.xml**
- **Microsoft.Practices.Prism.xml**
- **Microsoft.Practices.ServiceLocation.dll**
- **Microsoft.Practices.ServiceLocation.xml**
- **Microsoft.Practices.Unity.Configuration.dll**
- **Microsoft.Practices.Unity.Configuration.xml**
- **Microsoft.Practices.Unity.dll**
- **Microsoft.Practices.Unity.xml**
- **NLog.dll**
- **System.Windows.Interactivity.dll**
- **System.Windows.Interactivity.xml**
- **VistaCommon.dll**
- **VistaCommon.XmlSerializers.dll**

Chapter 7 VistA Imaging System M Files

The Food and Drug Administration classifies this software as a medical device. As such, it may not be changed in any way. Modifications to this software may result in an adulterated medical device under 21CFR820, the use of which is considered to be a violation of US Federal Statutes.

VA Policy states the following:

Those components of a national package (routines, data dictionaries, options, protocols, GUI components, etc.) that implement a controlled procedure, contain a controlled or strictly defined interface or report data to a database external to the local facility, must not be altered except by the Office of Information (OI) Technical Services (TS) staff. A controlled procedure is one that implements requirements that are mandated or governed by law or VA (Department of Veterans Affairs) directive or is subject to governing financial management standards of the Federal Government and VA or that is regulated by oversight groups such as the JCAHO or FDA. A controlled or strictly defined interface is one that adheres to a specific industry standard, will adversely affect a package and/or render the package inoperable if modified or deleted. For national software that is subject to FDA oversight, only the holder of the premarketing clearance (510(k)) is allowed to modify code for the medical device. The holder of a premarketing clearance is restricted to specifically designated TS staff that are located at the registered manufacturing site and operating in the designated production environment.

All routines files and fields of the VistA Imaging package may not be altered except by the OI Technical Services (TS) staff. This software is regulated by the FDA and implements controlled procedures. The only exception is data changes made in accord with Chapter 8 of this manual.

7.1 Introduction

The VistA Imaging System is based on the use of VA FileMan as an object-oriented database management system to store single or sequential images, and other multimedia object types.

This chapter first itemizes the various files that are used by the Imaging System (Clinical Capture/Display, Background Processor, and VistARad) and then describes how to obtain more detailed information about the files. Some of the files are used on the DICOM Image and Text Gateways and will reside on those systems and not on the VistA hospital system.

7.2 VA FileMan Files that are Part of the VistA Imaging System

7.2.1 VA FileMan Files

File	Name	Stored in
2005	IMAGE	^MAG(2005,D0,...
2005.01	-->EXPORT LOCATION	-->5,D1,...
2005.0106	-->ROUTING TIMESTAMP	-->4,D1,...

File	Name	Stored in
2005.011	-->LONG DESCRIPTION	-->3, D1, ...
2005.0111	-->ROUTING LOG	-->6, D1, ...
2005.04	-->OBJECT GROUP	-->1, D1, ...
2005.210	--> PRESENTATION STATE	-->210, D1, ...
2005.001	IMAGING STUDY	^MAG(2005.001, D0, ...
2005.002	IMAGING ANNOTATION FILE	^MAG(2005.002, D0, ...
2005.02	OBJECT TYPE	^MAG(2005.02, D0, ...
2005.21	-->ACTIONS	-->1, D1, ...
2005.24	-->CHILD CLASS	-->3, D1, ...
2005.021	IMAGE FILE TYPES	^MAG(2005.021, D0, ...
2005.03	PARENT DATA FILE	^MAG(2005.03, D0, ...
2005.1	IMAGE AUDIT	^MAG(2005.1, D0, ...
2005.11	-->EXPORT LOCATION	-->5, D1, ...
2005.1106	-->ROUTING TIMESTAMP	-->4, D1, ...
2005.111	-->LONG DESCRIPTION	-->3, D1, ...
2005.1111	--> ROUTING LOG	-->6, D1, ...
2005.14	-->OBJECT GROUP	-->1, D1, ...
2005.2	NETWORK LOCATION	^MAG(2005.2, D0, ...
2005.201	-->EMAIL	-->5, D1, ...
2005.4	IMAGE HISTOLOGICAL STAIN	^MAG(2005.4, D0, ...
2005.41	MICROSCOPIC OBJECTIVE	^MAG(2005.41, D0, ...
2005.6	IMAGING PATIENT REFERENCE	^MAGV(2005.6, D0, ...
2005.61	IMAGING PROCEDURE REFERENCE	^MAGV(2005.61, D0, ...
2005.62	IMAGE STUDY	^MAGV(2005.62, D0, ...
2005.63	IMAGE SERIES	^MAGV(2005.63, D0, ...
2005.64	IMAGE SOP INSTANCE	^MAGV(2005.64, D0, ...
2005.65	IMAGE INSTANCE FILE	^MAGV(2005.65, D0, ...
2005.66	IMAGING DUPLICATE UID LOG	^MAGV(2005.66, D0, ...
2005.71	IMAGING DICOM FIELDS	^MAG(2005.71, D0, ...
2005.712	MODULE	-->"M", D1,
2005.713	ELEMENT TAG	--> "E", D2,

File	Name	Stored in
2005.8	IMAGING SERVICE INSTITUTION	^MAGV(2005.8,D0,...
2005.81	MAG DESCRIPTIVE CATEGORIES	^MAG(2005.81,D0,...
2005.82	IMAGE INDEX FOR CLASS	^MAG(2005.82,D0,...
2005.83	IMAGE INDEX FOR TYPES	^MAG(2005.83,D0,...
2005.84	IMAGE INDEX FOR SPECIALTY/SUBSPECIALTY	^MAG(2005.84,D0,...
2005.85	IMAGE INDEX FOR PROCEDURE/EVENT	^MAG(2005.85,D0,...
2005.852	--> SPECIALTY	--> 1,D1,...
2005.86	IMAGE ACTIONS	^MAG(2005.86.D0,...
2005.865	-->TYPE	-->2,D1,...
2005.87	IMAGE LIST FILTERS	^MAG(2005.87,D0,...
2006.911	DICOM GATEWAY INSTRUMENT DICTIONARY	^MAGDICOM(2006.911,D0...
2006.912	DICOM GATEWAY MODALITY DICTIONARY	^MAGDICOM(2006.912,D0...
2006.913	ARTIFACT KEYLIST	^MAGV(2006.913,D0...
2006.914	RETENTION POLICY	^MAGV(2006.914,D0...
2006.915	ARTIFACT DESCRIPTOR	^MAGV(2006.915,D0...
2006.916	ARTIFACT	^MAGV(2006.916,D0...
2006.917	STORAGE PROVIDER	^MAGV(2006.917,D0...
2006.918	ARTIFACT INSTANCE	^MAGV(2006.918,D0...
2006.9191	MAGV GATEWAY CONFIGURATION	^MAGV(2006.9191,D0...
2006.9192	DICOM AE SECURITY MATRIX	^MAGV(2006.9192,D0,...
2006.9193	IMAGING APPLICATION SERVICE	^MAGV(2006.9193,D0,...
2006.921	ARTIFACT RETENTION POLICY	^MAGV(2006.921,D0,...
2006.922	RETENTION POLICY FULFILLMENT	^MAGV(2006.922,D0,...
2006.923	RETENTION POLICY STORAGE PROVIDER MAP	^MAGV(2006.923,D0,...
2006.924	STORAGE PROVIDER AVAILABILITY	^MAGV(2006.924,D0,...

File	Name	Stored in
2006.925	TRANSFER STATISTICS	^MAGV(2006.925,D0,...
2006.926	STORAGE TRANSACTION	^MAGV(2006.926,D0,...
2006.927	QUEUE	^MAGV(2006.927,D0,...
2006.928	QUEUE MESSAGE	^MAGV(2006.928,D0,...
2006.93	IMAGING EVENT AUDIT LOG	^MAGV(2006.93,D0,...
2006.931	IMAGING EVENT AUDITABLE ACTION	^MAGV(2006.931,D0,...
2006.941	MAG WORK ITEM	^MAGV(2006.941,D0,...
2006.9412	WORKLIST	^MAGV(2006.9412,D0,...
2006.9413	MAG WORK ITEM STATUS	^MAGV(2006.9413,D0,...
2006.9414	MAG WORK ITEM SUBTYPE	^MAGV(2006.9414,D0,...
2006.9421	MAGV IMPORT STUDY LOG	^MAGV(2006.9421,D0,...
2006.9422	MAGV IMPORT MEDIA LOG	^MAGV(2006.9422,D0,...
2005.88	MAG REASON FILE	^MAG(2005.88
2005.99	IMAGE INDEX FOR BODY PART	^MAG(2005.99,D0,...
2006.03	IMAGE BACKGROUND QUEUE	^MAGQUEUE(2006.03,D0,...
2006.031	IMAGE BACKGROUND QUEUE POINTER	^MAGQUEUE(2006.031,D0,...
2006.033	OFFLINE IMAGES	^MAGQUEUE(2006.033,D0,...
2006.034	IMPORT QUEUE	^MAG(2006.034,D0,...
2006.0341	-->IMAGE DATA	-->1,D1,...
2006.035	SEND QUEUE	^MAGQUEUE(2006.035,D0,...
2006.036	ROUTING STATISTICS	^MAGQUEUE(2006.036,D0,...
2006.03601	-->DETAILS	-->1,D1,...
2006.04	ACQUISITION DEVICE	^MAG(2006.04,D0,...
2006.041	ACQUISITION SESSION	^MAG(2007.041,D0,...
2006.1	IMAGING SITE PARAMETERS	^MAG(2006.1,D0,...
2006.11	-->MULTI NAMESPACE	-->4,D1,...
2006.112	-->FILE TYPES	-->2,D1,...
2006.12	--> ASSOCIATED INSTITUTIONS	--> INSTS,D1,...
2006.15	DICOM UID ROOT	^MAG(2006.15,D0,...
2006.166	--> BP MAIL MESSAGE	-->6,D1,...

File	Name	Stored in
2006.1662	-->--> Mail Group	-->1, D2, ...
2006.1664	-->--> MESSAGE RECIPIENTS	-->3, D2, ...
2006.1665	-->--> SECURITY KEYS	-->4, D2, ...
2006.17	MUSE VERSIONS	^MAG(2006.17, D0, ...
2006.171	MUSE TEST TYPES	^MAG(2006.171, D0, ...
2006.172	MUSE FORMAT TABLE	^MAG(2006.172, D0, ...
2006.18	IMAGING USER PREFERENCE	^MAG(2006.18, D0, ...
2006.1867	-->PATIENT LIST	-->"PATLIST", D1, ...
2006.19	IMAGING USERS	^MAG(2006.19, D0, ...
2006.191	-->ADDITIONAL NAMESPACE	-->1, D1, ...
2006.5	PACS MESSAGE	^MAGDHL7(2006.5, D0, ...
2006.502	-->MESSAGE SEGMENTS	-->1, D1, ...
2006.51	DICOM DATA ELEMENT DICTIONARY	^MAGDICOM(2006.51, D0, ...
2006.514	-->ENUMERATED VALUE	-->1, D1, ...
2006.511	DIAGNOSTIC INFO FIELD	^MAGDICOM(2006.511, D0, ...
2006.5112	-->TAG	-->1, D1, ...
2006.52	DICOM MESSAGE TEMPLATE DICTIONARY	^MAGDICOM(2006.52, D0, ...
2006.5204	-->MESSAGE	-->1, D1, ...
2006.53	DICOM UID DICTIONARY	^MAGDICOM(2006.53, D0, ...
2006.5305	-->UID	-->1, D1, ...
2006.531	EXTENDED SOP NEGOTIATION	^MAGDICOM(2006.531, D0, ...
2006.532	DICOM SOP CLASS	^MAG(2006.532, D0, ...
2006.539	DICOM UID SPECIFIC ACTION	^MAGDICOM(2006.539, D0, ...
2006.5391	-->PURPOSE	-->1, ...
2006.54	PDU TYPE	^MAGDICOM(2006.54, D0, ...
2006.55	DICOM WORKLIST PATIENT	^MAGDWLST(2006.55, D0, ...
2006.552	-->PATIENT	-->1, D1, ...
2006.5522	-->-->MEDICAL ALERT	-->-->1, D2, ...
2006.56	DICOM WORKLIST STUDY	^MAGDWLST(2006.56, D0, ...
2006.562	-->STUDY	-->1, D1, ...
2006.5621	-->-->PATIENT HISTORY	-->-->2, D2, ...

File	Name	Stored in
2006.5622	-->-->APPOINTMENT SCHEDULE	-->-->1, D2, ...
2006.563	DICOM GATEWAY PARAMETER	^MAGDICOM(2006.563, D0, ...
2006.5631	-->DATA PATH	-->"DATA PATH", D1...
2006.5632	-->PROFILE	-->"PROFILE", D1...
2006.5634	-->INSTALLATION	-->"INSTALL", D1...
2006.564	DICOM QUEUE	^MAGDICOM(2006.564, D0, ...
2006.5641	DICOM GATEWAY MACHINE ID	^MAGDICOM(2006.5641, D0, ...
2006.565	EXPORT DICOM RUN FILE	^MAGDICOM(2006.565, D0, ...
2006.57	DICOM HL7 SEGMENT	^MAGDICOM("HL7", D0, ...
2006.5701	-->ELEMENT	-->1, D1, ...
2006.571	DICOM RAW IMAGE	^MAGDICOM(2006.571, D0, ...
2006.5711	DICOM M2MB RPC QUEUE	^MAGDINPT(2006.5711, D0, ...
2006.5712	DICOM FIXED QUEUE	^MAGDINPT(2006.5712, D0, ...
2006.5713	DICOM UNKNOWN MODALITY	^MAGDINPT(2006.5713, D0, ...
2006.5714	DICOM INCOMPLETE OBJECT	^MAGDINPT(2006.5714, D0, ...
2006.5715	CURRENT IMAGE	^MAGD(2006.5715, D0, ...
2006.5719	DICOM ERROR LOG	^MAGDINPT(2006.5719, D0, ...
2006.572	EXAMINATION COMPLETE	^MAGDINPT(2006.572, D0, ...
2006.573	GE PACS QUERY/RETRIEVE	^MAGDGEQR(2006.573, D0, ...
2006.5732	DICOM QUERY RETRIEVE RESULT	^MAGQR(2006.5732, D0, ...
2006.57321	-->TAG	-->1, D1, ...
2006.5733	QUERY/RETRIEVE STATISTICS	^MAG(2006.5733, D0, ...
2006.57331	-->LOCATION	-->1, ...
2006.574	DICOM IMAGE OUTPUT	^MAGDOUTP(2006.574, D0, ...
2006.5744	-->IMAGE	--> -->1, D1, ...
2006.575	DICOM FAILED IMAGES	^MAGD(2006.575, D0, ...
2006.5751	DICOM OBJECTS TO BE IMPORTED	^MAGDICOM(2006.5751, D0, ...
2006.5752	IMPORTABLE DICOM OBJECTS	^MAGD(2006.5752, D0, ...
2006.57526	-->RELATED IMAGES	-->"RLATE", D1, ...

File	Name	Stored in
2006.5757	DICOM RADIOLOGY PROCEDURE MODIFIERS	^MAGDICOM(2006.5757,D0,...
2006.5758	DICOM RADIOLOGY PROCEDURES	^MAGDICOM(2006.5758,D0,...
2006.5759	OUTSIDE IMAGING LOCATION	^MAGD(2006.5759,D0,...
2006.5761	DICOM MESSAGE STATISTICS	^MAGDAUDT(2006.5761,D0,...
2006.57611	-->MESSAGE	-->1,D1,...
2006.5762	DICOM INSTRUMENT STATISTICS	^MAGDAUDT(2006.5762,D0,...
2006.57621	-->LOCATION	-->1,D1,...
2006.5762111	-->-->INSTRUMENT	-->-->1,D2,... CONSNON>
2006.57621	-->INSTRUMENT	-->1,D1,...
2006.5763	DICOM PACS STATISTICS	^MAGDAUDT(2006.5763,D0,...
2006.57631	-->ACCESSION NUMBER	-->1,D1,...
2006.576311	-->-->EVENT	-->-->1,D2,...
2006.5764	DICOM LOCAL INSTRUMENT STATISTICS	^MAGDICOM(2006.5764,D0,...
2006.57641	-->DATE	-->1,D1,...
2006.577	DICOM FIFO QUEUE	^MAGDICOM(2006.577,D0,...
2006.5771	-->QUEUE LETTER	-->1,D1,...
2006.58	DICOM LOG	^MAGDMLOG(D0,...
2006.5801	-->TEXT	-->1,D1,...
2006.5802	-->LINE	-->2,D1,...
2006.581	INSTRUMENT DICTIONARY	^MAGDICOM(2006.581,D0,...
2006.582	MODALITY TYPE DICTIONARY	^MAGDICOM(2006.582,D0,...
2006.5821	CT CONVERSION PARAMETERS	^MAGDICOM(2006.5821,D0,...
2006.583	MODALITY WORKLIST DICTIONARY	^MAGDICOM(2006.583,D0,...
2006.5831	DICOM HEALTHCARE PROVIDER SERVICE	^MAGDICOM(2006.5831,D0,...
2006.5839	DICOM GMRC TEMP LIST	^MAGDICOM(2006.5839,D0,...
2006.584	TCP/IP PROVIDER PORT LIST	^MAGDICOM(2006.584,D0,...

File	Name	Stored in
2006.5841	TELEREADER ACQUISITION SERVICE	^MAG(2006.5841,D0,...
2006.5842	TELEREADER ACQUISITION SITE	^MAG(2006.5842,D0,...
2006.5843	TELEREADER READER	^MAG(2006.5843,D0,...
2006.5849	TELEREADER READ/UNREAD LIST	^MAG(2006.5849,D0,...
2006.585	USER APPLICATION	^MAGDICOM(2006.585,D0,...
2006.5852	-->SOP CLASS	-->1,D1,...
2006.58522	-->-->TRANSFER SYNTAX	-->-->1,D2,...
2006.586	PROVIDER APPLICATION	^MAGDICOM(2006.586,D0,...
2006.5863	-->SOP	-->1,D1,...
2006.58633	-->-->TRANSFER SYNTAX UID	-->-->1,D2,...
2006.587	DICOM TRANSMIT DESTINATION	^MAG(2006, 587,...
2006.588	APPLICATION ENTITY TITLE	^MAGDICOM(2006.588,D0,...
2006.59	ROUTING RULE	^MAGDICOM(2006.59,D0,...
2006.5901	-->RAW TEXT	-->1,D1,...
2006.5902	-->ACTION	-->ACTION,D1,...
2006.5903	--> -->PARAMETER	--> -->1,D2,...
2006.5904	-->CONDITION	--> -->1,D2,...
2006.5905	--> -->TIMEFRAME	--> -->1,D2,...
2006.5906	ROUTE LOAD BALANCE	^MAGRT(2006.5906,D0,...
2006.59061	-->PARENT	-->1,D1,...
2006.596	ACTION QUEUE STATUS	^MAGDICOM(2006.596,D0,...
2006.5961	-->THREAD	-->1,D1,...
2006.598	DICOM ERROR MESSAGE QUEUE	^MAGD(2006.598,D0,...
2006.599	DICOM Error Log	^MAGD(2006.599,D0,...
2006.621	MAG CT PARAMETER	^MAG(2006.621,D0,...
2006.623	MAG CR PARAMETER	^MAG(2006.623,D0,...
2006.63	MAG RAD LIST DATA ELEMENTS	^MAG(2006.63,D0,...

File	Name	Stored in
2006.631	MAG RAD LISTS DEFINITION	^MAG(2006.631,D0,...
2006.6311	-->COLUMNS	-->1,D1,...
2006.6312	-->SORT	-->2,D1,...
2006.634	MAGJ ZLIST SEARCH FILE	^MAG(2006.634,D0,...
2006.65	MAG RAD PRIOR EXAM LOGIC	^MAG(2006.65,D0,...
2006.66	-->PRIOR CASE MATCHING CPT GROUP	-->1,D1,...
2006.67	MAG RAD CPT MATCHING	^MAG(2006.67,D0,...
2006.674	-->BODY PART	-->1,...
2006.675	-->MODALITY	-->2,...
2006.68	MAGJ USER DATA	^MAG(2006.68,D0,...
2006.682	-->VR-WS	-->VR-WS,D1,...
2006.6821	-->--->DATA	-->--->VR-WS,D1,1,...
2006.6823	-->--->KEYS	-->--->VR-WS,D1,2,...
2006.683	-->VR-HP	-->VR-HP...
2006.6831	-->--->DATA	-->--->VR-HP,D1,1,...
2006.6832	-->--->KEYS	-->--->VR-HP,D1,2,...
2006.69	MAG VISTARAD SITE PARAMETERS FILE	^MAG(2006.69,D0,...
2006.8	BP WORKSTATIONS	^MAG(2006.8,D0,...
2006.81	IMAGING WINDOWS WORKSTATIONS	^MAG(2006.81,D0,...
2006.82	IMAGING WINDOWS SESSIONS	^MAG(2006.82,D0,...
2006.821	-->ACTIONS	-->"ACT",D1,...
2006.823	-->ERRORS	-->"ERR",D1,...
2006.83	DICOM WORKSTATION	^MAG(2006.83,D0,...
2006.87	DICOM GATEWAY INFORMATION	^MAG(2006.87,D0,...
2006.95	IMAGE ACCESS LOG	^MAG(2006.95,D0,...
2006.96	IMAGE INDEX CONVERSION	^MAGIXCVT (2006.96,D0...
2006.961	MULTI IMAGE PRINT FILE	^MAG(2006.961,
2006.9613	-->IMAGES PRINTED SUB- FILE	^MAG(2006.961,D0,"IMG",

7.2.2 More Detailed Information

More detailed information about these files can be obtained using the FileMan option LIST FILE ATTRIBUTES. The Data Dictionaries are considered part of the online documentation for this software application. It may be necessary to print the Data Dictionaries in order to support the package at your site.

The Data Dictionaries for VistA Imaging files may be printed using the VA FileManager's option LIST FILE ATTRIBUTES under the DATA DICTIONARY UTILITIES menu as follows:

```

VA FileMan 22.0

Select OPTION: DATA DICTIONARY UTILITIES
Select DATA DICTIONARY UTILITY OPTION: LIST FILE ATTRIBUTES
START WITH WHAT FILE: // IMAGE
      GO TO WHAT FILE: // IMAGE
      Select SUB-FILE: <RET>
Select LISTING FORMAT: STANDARD// BRIEF
ALPHABETICALLY BY LABEL? NO// YES
DEVICE:

```

The Data Dictionary will now print on the user's specified device.

7.3 Input Templates

The distribution contains the following input templates:

```

FILE #2005 MAG IMAGE INDEX EDIT
FILE #2006.1: MAG PURGE PARAMETERS
FILE #2006.1: MAG SITE PARAMETERS
FILE #2006.1: MAG MUSE PARAMETERS
FILE #2005.2: MAG ENTER/EDIT NETWORK LOC
FILE #2005.2: MAG ENTER/EDIT MUSE NETWORK
FILE #2005.575: MAGD-ENTRY
FILE #2005.575: MAGD-UPDT
FILE #2005.88: MAG REASON EDIT
FILE #2006.8: MAG EDIT BACKGRND WORKSTA
FILE #2006.631: MAGJ LIST EDIT
FILE #2006.65: MAGJ PRIOR EDIT

```

7.3.1 Further Information

Every individual object (i.e., an image, audio clip, waveform, or scanned document) is an entry in the IMAGE file (#2005), where the object's attributes are managed. In addition, three auxiliary files are used:

- Object Type
- Network Location
- Parent Data

The objects are then related to the patient's VistA text data (medicine, surgery, laboratory, radiology reports or progress notes) through the use of pointers, both forward from the VistA

PACKAGE file (#9.4) to the IMAGE file (#2005), and backwards from the IMAGE file (#2005) to the VistA PACKAGE file (#9.4). Software allows new objects to be added and displayed.

Several additional files are used by the system. These include:

- IMAGING WINDOWS WORKSTATIONS file (#2006.81), which contains information about every workstation on the network.
- IMAGE HISTOLOGICAL STAIN file (#2005.4), and the MICROSCOPIC OBJECTIVE file (#2005.41) used by anatomic pathology.
- IMAGING SITE PARAMETERS file (#2006.1).
- Background Queue files, which are necessary to manage abstract creation, automatic file migration (movement of image/object files between optical disk jukebox and magnetic disk), file copies.
- IMAGE ACCESS LOG file (#2006.95) used to track system utilization.
- User preferences files, which store personal preferences for the software configuration of the workstation.
- IMAGE LIST FILTERS file (#2005.87), which stores personal filters for each user, and public filters for all users.
- IMAGE FILE TYPES file (#2005.021), which lists all image formats that VistA Imaging supports.
- IMAGING ANNOTATION file (#2005.002), which stores annotation information that is associated with an image.
- Parameters that are specific for each individual DICOM Gateway Computer.
- Master files that drive the operation of the DICOM Gateway.
- Modality Worklist file that contains the scheduled activities for the various modalities that acquire images.
- Incoming Images.
- Images that need manual intervention before they can be entered into the VistA HIS.

7.4 File List

The VistA Imaging System files are in the 2005 through the 2006.999 numbering space. Full file and field documented attributes on any Imaging files can be obtained using the LIST FILE ATTRIBUTES sub-menu option located in the 'Data Dictionary Utilities menu.

```

VA FileMan 22.0
Select OPTION: DATA DICTIONARY UTILITIES
Select DATA DICTIONARY UTILITY OPTION: LIST FILE ATTRIBUTES
START WITH WHAT FILE: DICOM FAILED IMAGES// 2005 IMAGE (7495 entries)
GO TO WHAT FILE: IMAGE//
Select SUB-FILE:
Select LISTING FORMAT: STANDARD//
DEVICE: UCX LOGIN Right Margin: 80//

```

7.5 Files Introduced in MAG*3.0*34

The new data structure introduced in MAG*3.0*34 includes these files:

- **IMAGING PATIENT REFERENCE file (#2005.6)**
The file contains information about each patient with which imaging procedures and studies are associated within VistA.
- **IMAGING PROCEDURE REFERENCE file (#2005.61)**
The file contains information about each procedure corresponding to an entry in the IMAGING PATIENT REFERENCE file (#2005.6).
- **IMAGE STUDY file (#2005.62)**
The file contains information about each study corresponding to an entry in the IMAGING PROCEDURE REFERENCE file (#2005.61).
- **IMAGE SERIES file (#2005.63)**
The file contains information about each series corresponding to an entry in the IMAGE STUDY file (#2005.62).
- **IMAGE SOP INSTANCE file (#2005.64)**
The file contains information about each SOP instance in the IMAGE SERIES file (#2005.63).
- **IMAGE INSTANCE FILE file (#2005.65)**
The file contains information about each physical file instance corresponding to an entry on the IMAGE SOP INSTANCE file (#2005.64).
- **IMAGING DUPLICATE UID LOG file (#2005.66)**
The file contains information about duplicate UIDs.
- **IMAGING SERVICE INSTITUTION file (#2005.8)**
The file contains entries indicating the Imaging institution associated with an action performed on an Imaging file entry.
- **DICOM GATEWAY INSTRUMENT DICTIONARY file (#2006.911)**
The file contains information about the instruments that communicate with the DICOM Gateway.
- **DICOM GATEWAY MODALITY DICTIONARY file (#2006.912)**
The file contains information about the various types of image acquisition devices that are present at a site. Note that a modality is a class of devices; an instrument is a specific device or an instance of such a class.
- **ARTIFACT KEYLIST file (#2006.913)**
The file includes information that allows clients of the storage system, such as display clients and the Query/Retrieve application to retrieve artifacts (images) stored in the VistA system at the site.
- **RETENTION POLICY file (#2006.914)**
The file contains information about the various retention policies available to the storage system. Retention policies can be user-definable or business.

- **ARTIFACT DESCRIPTOR file (#2006.915)**
The file acts as the entry point into the storage system. It holds information about a particular type of artifact (such as the artifact type `MedicalImage`, which is an image in DICOM format) and maps this type of artifact to its intrinsic retention policy. The file also stores the file extension that is used for files of the given type. Artifact descriptors records are created when the patch is installed. Users cannot delete or modify these records or create new ones.
- **ARTIFACT file (#2006.916)**
The file holds records with information about the artifact: CRC, size, who the artifact was created by, a link back to the artifact descriptor, and so on. (An artifact is an object that the storage system stores, such as an image, a text file, a report, an abstract.)
- **STORAGE PROVIDER file (#2006.917)**
The file includes information about the devices used at the site. It contains one record for each device. For example, if there is a consolidated site with a RAID in place A, a RAID in place B, and an archive in place B, there would be 3 entries in the file. The information in the file is used to determine whether a particular configuration is valid at configuration and at runtime.
- **ARTIFACT INSTANCE file (#2006.918)**
The file holds the details of a particular instance of the binary data for an artifact. Each record is owned by a specific provider and has a reference to its parent artifact record, as well as a URL that the given provider can understand and that can be used to return a stream for the artifact. The file also includes properties related to when the file was created, when it was last accessed, and so on.
- **MAGV GATEWAY CONFIGURATION file (#2006.9191)**
The file contains configuration parameters of the DICOM Gateways connected to the VistA system at the specific site.
- **DICOM AE SECURITY MATRIX file (#2006.9192)**
The file contains a list of the devices (application entities) that can connect to the VistA system and their parameters, which include the type of access they have to the system (defined as the DICOM service and role).
- **IMAGING APPLICATION SERVICE file (#2006.9193)**
The file contains VistA Imaging applications or services, such as HDIG, DICOM Importer II, and VI DICOM Storage SCP.
- **ARTIFACT RETENTION POLICY file (#2006.921)**
The file maps an artifact to the set of retention policies currently and also historically in effect for that artifact.
- **RETENTION POLICY FULFILLMENT file (#2006.922)**
The file maps a running history of how particular retention policies caused artifacts to be written to specific storage providers. It is also used by asynchronous archiving to determine which retention policies have not yet been satisfied and which storage providers still need to be written to.

- **RETENTION POLICY STORAGE PROVIDER MAP file (#2006.923)**
The file maps retention policies, through an acquisition location, to the storage providers that should be used to satisfy the retention policies. It also contains a flag indicating whether a particular storage provider should be called synchronously or asynchronously.
- **STORAGE PROVIDER AVAILABILITY file (#2006.924)**
The file contains information about the availability of a connection between an acquisition place and a particular storage (archive) provider. If there is a record for a particular storage provider/acquisition location pair, the connection is only available between the start and end times indicated in the record. If there is no record, the connection is always available.
- **TRANSFER STATISTICS file (#2006.925)**
The file contains statistics about network transfers between a storage provider and a client endpoint, including the time of day the transfer occurred, the duration of the transfer, and the size of the artifact.
- **STORAGE TRANSACTION file (#2006.926)**
The file records the actions for a particular artifact, such as: storing the artifact successfully in a specific storage provider; failed attempts to store the artifact in a storage provider; retrieving the artifact from a particular storage provider; failed attempts to retrieve the artifact from a storage provider.
- **QUEUE file (#2006.927)**
The file is a list of Queues (queue types). It contains the queue for asynchronous storage requests, the queue for failed asynchronous storage requests, the Abstract Maker queue and the queue for sending email notifications.
- **QUEUE MESSAGE file (#2006.928)**
The file stores the messages for the requests for all queues defined in the QUEUE file. Each record in the file contains information about the queued request: the message itself, a reference to the queue, the priority of the request, the minimum delivery date/time, and expiration date/time of the message. The file is used by internal processes to carry out the actions for all queued requests.
- **IMAGING EVENT AUDIT LOG file (#2006.93)**
The file contains a list of all audited events.
- **IMAGING EVENT AUDITABLE ACTION file (#2006.931)**
The file contains the list of VistA Imaging events that can be audited.
- **MAG WORK ITEM file (#2006.941)**
The file contains a queue of work items for worklists in the WORKLIST file (#2006.9412).
- **WORKLIST file (#2006.9412)**
The file contains entries for worklists and their current activity status.
- **MAG WORK ITEM STATUS file (#2006.9413)**
This file contains work item statuses.

- **MAG WORK ITEM SUBTYPE file (#2006.9414)**
This file contains work item subtypes.
- **MAGV IMPORT STUDY LOG file (#2006.9421)**
The file contains a log of import events carried out by the DICOM Importer II at the study level. These include user and study information, and counts of the total number of series and objects imported, the number of objects that failed to import, and of the number of objects imported for each modality contained within the study. This information allows generation of reports covering importer activity for a user-specified time period.
- **MAGV IMPORT MEDIA LOG file (#2006.9422)**
The file holds a log of import events carried out by the DICOM Importer II at the media bundle level. A media bundle is a group of studies under a single Importer II work item. A media bundle may or may not represent a single piece of media or a single network transaction. This file includes information about media validity, the user who reconciled the associated studies, the workstation, as well as the source of the imported media.

7.6 Sort and Print Templates

Sort and Print Templates for the IMAGING PATIENT REFERENCE File (#2005.6)

- **MAGV-PAT-QUERY** – This sort template enables users to retrieve study, series, image, and file information for a single patient or a range of patients, based on the value of the ENTERPRISE PATIENT ID field (#.01).
- **MAGV-PAT-QUERY** – This print template returns a report with the following information:

For each requested patient:	Name and social security number
For each of the patient’s procedures:	Procedure ID
For each study within the procedure:	Study instance UID Description Modalities in study
For each series within the study:	Series instance UID Description Modality
For each SOP instance within the series:	SOP instance UID SOP class UID
For each file within the SOP instance:	Fileref

Sort and Print Templates for the IMAGING PROCEDURE REFERENCE File (#2005.61)

- **MAGV-PROC-QUERY** – This sort template enables users to retrieve study and series information for a single procedure or a range of procedures, based on the value of the **PROCEDURE ID** field (#.01).
- **MAGV-PROC-QUERY** – This print template returns a report with the following information:

For each requested procedure:	Procedure ID
For the associated patient:	Social security number Name Date of birth
For each study within the procedure:	Study instance UID Description Modalities in study
For each study within the procedure:	Study instance UID
For each series within the study:	Series instance UID

Sort and Print Templates for the ARTIFACT INSTANCE File (#2006.918)

- **MAGV-FILEREF-QUERY** – This sort template enables users to retrieve patient, study, and series information for a single file or a range of files based on the value of the **FILEREF** field (#6).
- **MAGV-FILEREF-QUERY** – This print template returns the following information:

For each requested file:	File name
For the associated patient:	Social security number Name Sex Date of birth
For each study within the procedure:	Study instance UID Description Modalities in study
For each study within the procedure:	Study instance UID
For each series within the study:	Series instance UID

Sort Template for the QUEUE MESSAGE File (#2006.928)

- **MAGVA-ASYNC-STORAGE-ERRORS** – This sort template is for system use only. It is used by Hybrid DICOM Gateway Menu [MAGV HDIG MENU] Option Find Async Storage Request Errors [MAGVA ASYNC STORAGE ERR QURY] to store results of a query for Asynchronous Storage Request Error Queue entries in the QUEUE MESSAGE file (#2006.928), and by Option List Async Storage Request Errors [MAGVA ASYNC STORAGE ERR LIST] to display information about the entries.

7.7 File List

The VistA Imaging System files are in the 2005 through the 2006.999 numbering space. Full file and field documented attributes on any Imaging files can be obtained using the LIST FILE ATTRIBUTES sub-menu option located in the 'Data Dictionary' Utilities menu.

```

VA FileMan 22.0
Select OPTION: DATA DICTIONARY UTILITIES
Select DATA DICTIONARY UTILITY OPTION: LIST FILE ATTRIBUTES
  START WITH WHAT FILE: DICOM FAILED IMAGES// 2005 IMAGE      ((20235entries)
    GO TO WHAT FILE: IMAGE//2006.961 MULTI IMAGE PRINT
Select LISTING FORMAT: STANDARD//
Start with field: FIRST//
DEVICE: 0 TELNET  Right Margin: 80

Select OPTION: DATA DICTIONARY UTILITIES
Select DATA DICTIONARY UTILITY OPTION: LIST FILE ATTRIBUTES
  START WITH WHAT FILE: DICOM FAILED IMAGES// 2005 IMAGE      ((20235entries)
    GO TO WHAT FILE: IMAGE//2006.961 MULTI IMAGE PRINT
Select LISTING FORMAT: STANDARD//
Start with field: FIRST//
DEVICE: 0 TELNET  Right Margin: 80

```

7.8 File Security

VistA Imaging recommends no access to any Imaging files by any end-user other than IRM personnel. Please review the Security manual to get a detail listing of all FileMan protections on all Imaging files. All updating of Imaging files is done via the GUI interface or by the Imaging System Manager menu (locked by the MAG SYSTEM security key) on the VistA hospital system. However, the recommended method is to use the VistA Imaging Background Processor application (GUI).

The following imaging entity relationship diagram shows the data structures that existed before the release of MAG*3.0*34.

Imaging Entity Relationship Diagram and Detailed Information

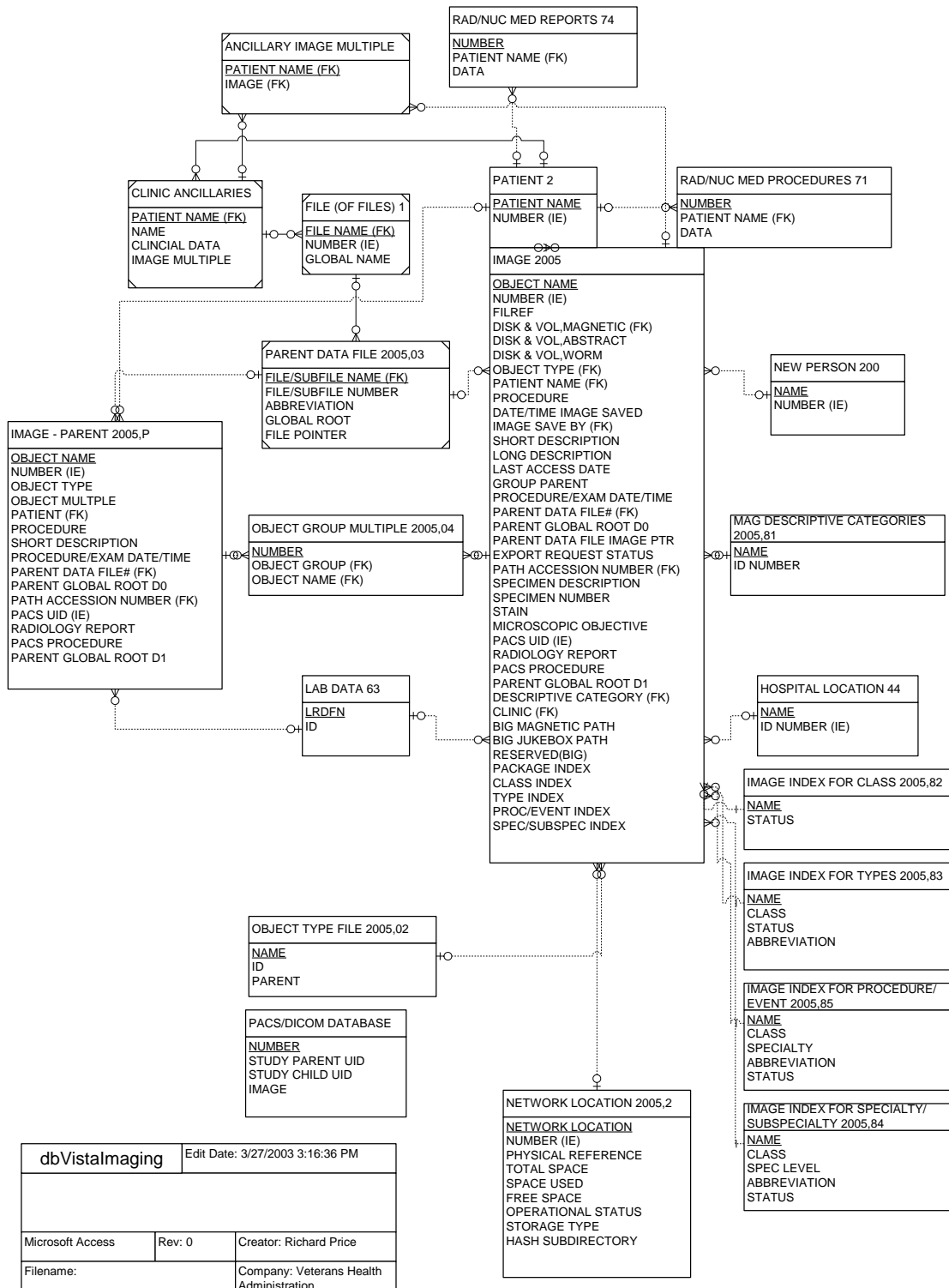

A detailed File Diagram can be obtained using the FileMan's menu option 'MAP POINTER RELATIONS'.

- Select 'DATA DICTIONARIES UTILITIES' from the FileMan menu.
- Select 'MAP POINTER RELATIONS' menu option.
- Respond to the 'PACKAGE NAME' prompt with IMAGING.

The following imaging entity relationship diagram shows the data structures that were introduced in MAG*3.0*34. The diagram includes key fields for each table, It also shows the pointers to other data structures: the old data structures and non-VistA Imaging data tables.

Imaging Entity Relationship Diagram: Data Structures Introduced in MAG*3.0*34

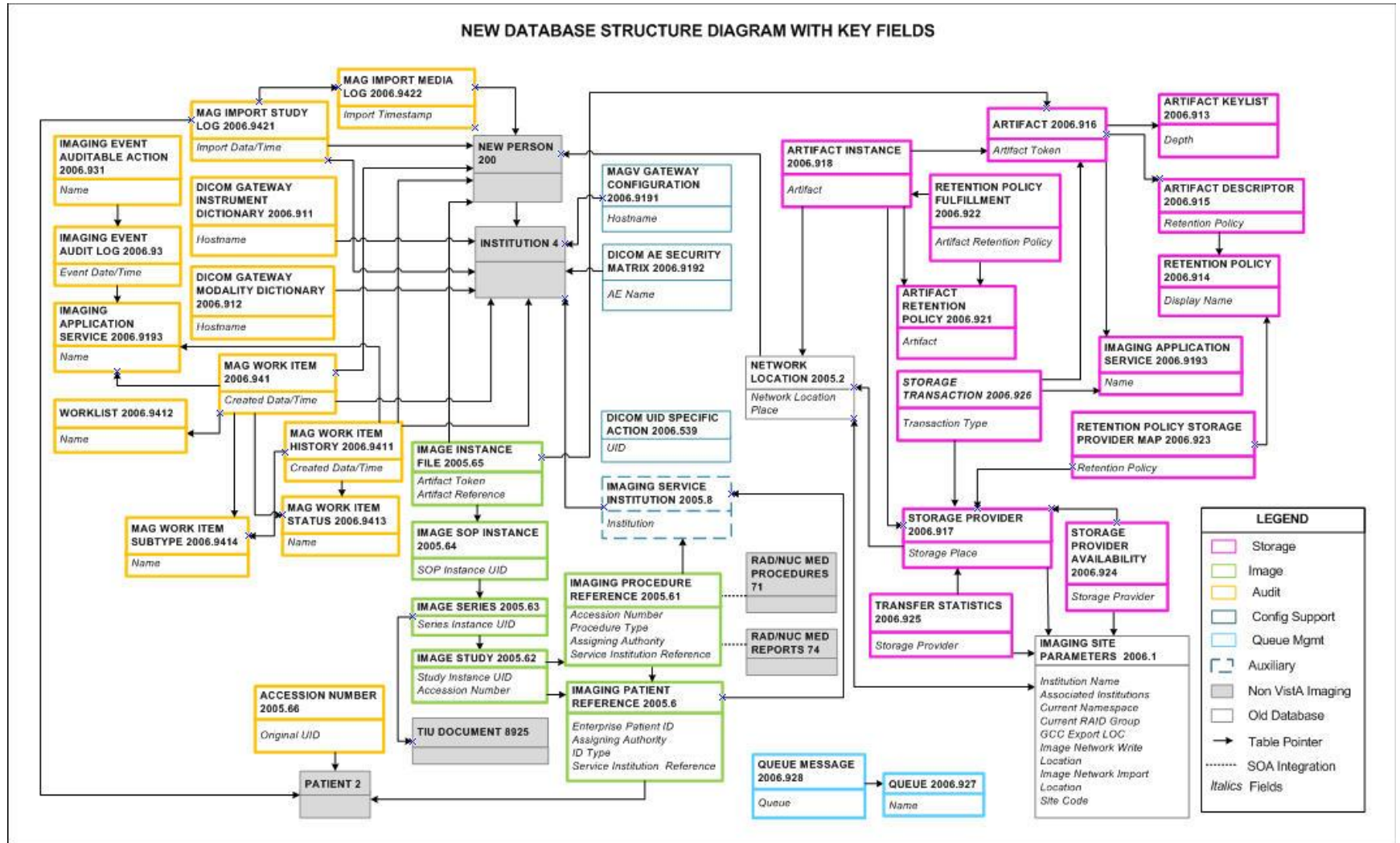

A detailed and current File Diagram can be obtained using the FileMan's menu option 'MAP POINTER RELATIONS'.

- Select 'DATA DICTIONARIES UTILITIES' from the FileMan menu.
- Select 'MAP POINTER RELATIONS' menu option.
- Respond to the 'PACKAGE NAME' prompt with IMAGING.

7.9 Global Journaling

Journaling of the VistA Imaging global is mandatory. MAG* should be journaled.

During a scheduled VistA (hospital) server downtime, it is highly recommended to coordinate any data restore activities related to the VistA Imaging System with the IRM staff.

7.10 VistA System Outages

During a VistA System outage, DICOM Gateways will continue to provide modality worklist functionality and to capture images that are temporarily stored on the gateway. This is important to allow the radiology department to continue to perform studies. If you anticipate that the VistA System must be down, it is best to take the following steps:

- Perform all DICOM fixes before the VistA System goes down. This will free the maximum space for temporary image storage.
- During the outage, watch the gateways to be sure they still have adequate space to store images.

This page is intentionally blank.

Chapter 8 Exported Options

8.1 Introduction: INI File Setup and Configuration of Workstations

INI files are DOS files with the extension .ini (such as win.ini and mouse.ini) that contain initialization information for programs. Initialization refers to the parameters that control the way a program is initially launched. They also customize the application to accommodate workstation-specific characteristics, such as the type of capture hardware installed (Refer to *Vista Imaging System Installation Guide* for further details). The INI files are set up initially when the software is first installed on the workstation.

8.2 Imaging System Manager Menu [MAG SYS MENU]

The Imaging System Manager Menu [MAG SYS MENU] contains system manager functions. Access to these menu options requires the MAG SYSTEM security key.

Menu Diagram for Imaging System Manager Menu [MAG SYS MENU]

```
HL7   Imaging HL7 Messaging Maintenance ...
IX    Image Index Conversion Menu ...
LS    Edit Network Location STATUS
TR    Telereader Menu ...
      Ad hoc Enterprise Site Report
      Configure AE Security Matrix Settings
      Delete Image Group
      Delete Study by Accession Number
      DICOM Menu Options ...
      Enter/edit Reason
      Hybrid DICOM Gateway Menu ...
      Imaging Database Integrity Checker Menu ...
      Imaging Site Reports ...
      Importer Menu ...
```

Editing the Network Location Status should be performed by using the Network Location Manager in the Background Processor.

Imaging Database Integrity checking should be performed in the Background Processor using the Verifier application.

Note: You can enter ??? at the Select Imaging System Manager Menu Option prompt for a description of each menu option.

See the *Background Processor User Manual* for more information.

For detailed information about the ‘Telereader Menu ...’ option, refer to the TeleReader Configuration document.

For detailed information about the “Ad hoc Enterprise Site Report” option and the “Imaging Site Reports” option, refer to Chapter 12.

8.2.1 Imaging HL7 Messaging Maintenance [Mag HL7 Maint]

This option contains sub-options that allow you to modify parameters relating to the transmission of HL7 ADT messages to commercial PACS (cPACS) and to select the version of HL7 order messages that should be sent from Vista Radiology to cPACS and to the Vista Text Gateway.

Note: If you need help with the sub-options of this option, consult the designated HL7 specialist within the IRM department at your site.

Menu Diagram for Imaging HL7 Messaging Maintenance [MAG HL7 MAINT]

```
RHL7 Maintain Subscriptions to Radiology HL7 Drivers
IHE Configure IHE-Based HL7 Interface to PACS
```

8.2.1.1 Maintain Subscriptions to Radiology HL7 Drivers [Magd Maint Rad HL7 Subs]

This option allows you to select the version of HL7 order messages that should be sent from VistA Radiology to cPACS and to the VistA Text Gateway.

From the Imaging System Manager Menu, select HL7:

```
Select Imaging System Manager Menu Option: HL7 Imaging HL7 Messaging Maintenance
```

From the Imaging HL7 Messaging Maintenance Menu, select RHL7:

```
Select Imaging HL7 Messaging Maintenance Option: RHL7 Maintain Subscriptions to Radiology HL7 Drivers
```

VistA Imaging first verifies that all applicable HL7 protocols are available. There are two Imaging subscriber protocols and eight Radiology event driver protocols – four for HL7 Version 2.1 messages and four for HL7 Version 2.4 messages.

```
MAGD SEND ORM protocol found...

MAGD SEND ORU protocol found...

RA CANCEL protocol found...
RA EXAMINED protocol found...
RA REG protocol found...
RA RPT protocol found...
RA CANCEL 2.4 protocol found...
RA EXAMINED 2.4 protocol found...
RA REG 2.4 protocol found...
RA RPT 2.4 protocol found...
```

VistA Imaging then asks which version of HL7 you wish to be used to generate Radiology messages. Enter 2.1 or 2.4.

```
Enter the desired version of HL7: 2.4 HL7 Version 2.4
```

If the desired HL7 version is not currently in use, VistA Imaging adjusts protocol subscriptions to cause the desired version to come into use.

```
Subscribing to HL7 version 2.4 protocols...
Protocol RA CANCEL has been unsubscribed from...
Protocol RA EXAMINED has been unsubscribed from...
Protocol RA REG has been unsubscribed from...
Protocol RA RPT has been unsubscribed from...
Protocol RA CANCEL 2.4 has been subscribed to...
Protocol RA EXAMINED 2.4 has been subscribed to...
Protocol RA REG 2.4 has been subscribed to...
Protocol RA RPT 2.4 has been subscribed to...
```

If the desired HL7 version is already in use, the system will take no action.

```
Subscribing to HL7 version 2.4 protocols...
Protocol RA CANCEL is not currently subscribed to, no action taken...
Protocol RA EXAMINED is not currently subscribed to, no action taken...
Protocol RA REG is not currently subscribed to, no action taken...
Protocol RA RPT is not currently subscribed to, no action taken...
Protocol RA CANCEL 2.4 is already subscribed to, no action taken...
Protocol RA EXAMINED 2.4 is already subscribed to, no action taken...
Protocol RA REG 2.4 is already subscribed to, no action taken...
Protocol RA RPT 2.4 is already subscribed to, no action taken...
```

8.2.1.2 Configure Ihe-Based HL7 Adt Interface To Pacs

This option allows you to modify parameters relating to the transmission of HL7 version 2.4 ADT messages to commercial PACS (if used) and the DICOM Text Gateway.

From the Imaging System Manager Menu, select HL7:

```
Select Imaging System Manager Menu Option: HL7 Imaging HL7 Messaging Maintenance
```

From the Imaging HL7 Messaging Maintenance Menu, select IHE:

```
Select Imaging HL7 Messaging Maintenance Option: IHE Configure IHE-Based HL7 Interface to PACS
```

Vista Imaging first asks you to verify the name of the sending application and the receiving application. These are the applications in the HL7 APPLICATION PARAMETER File (#771) whose NAME Field values are associated with the entries in field 3 and 5 respectively, and whose FACILITY NAME Field values are associated with the entries in fields 4 and 6 respectively, of the Message Header (MSH) segments of the outbound HL7 messages

Note: This option only changes the names of the sending and receiving applications. To change the names of the sending and receiving facilities, get help from the designated HL7 specialist within the IRM department at your site.

```
Sending application name:  MAG VISTA IMGNG
Receiving application name: MAG COMRCL PACS

Do you wish to change either of these names?
```

If you wish to accept the application names that are presented, enter **N**. Otherwise, enter **Y** and enter the desired new application names at the prompts:

```
Please enter the name of the SENDING application.
NAME: MAG VISTA IMGNG// ← enter the new sending application name here
Please enter the name of the RECEIVING application.
NAME: MAG COMRCL PACS// ← enter the new receiving application name here
```

VistA Imaging next asks you to enter the TCP/IP address and port number of the logical link over which the outbound VistA HL7 stream will be transmitted to cPACS.

```
Please enter the TCP/IP address and port number for the logical link.
TCP/IP ADDRESS: ← enter the TCP/IP address here
TCP/IP PORT: ← enter the port number here
```

Finally, you are asked whether you wish to turn on the IHE-based PACS interface, which will transmit IHE-conformant ADT HL7 messages from VistA HIS to cPACS (if used) and to the DICOM Text Gateway.

```
Enter Y or YES below to turn the IHE-based HL7 PACS interface ON;
enter N or NO to turn the interface OFF.

IHE PACS HL7 INTERFACE ACTIVE:
```

Enter **Y** to turn the interface on or **N** to turn it off.

8.3 Configure AE Security Matrix Settings [MAGV AE SEC MX SETTINGS]

This menu lets users edit the DICOM AE SECURITY MATRIX file (#2006.9192). The file contains a list of application entity (AE) titles: all remote devices that can connect to the local VistA system and its components. It also determines which devices can connect to the VistA system and the type of access that they are allowed (a combination of DICOM service and the DICOM role associated with this service). For example, a device that is a Service Class User (SCU) of the Storage Service Class (C-STORE) can send DICOM objects to a DICOM Gateway that is defined as a Service Class Provider (SCP) of the Storage Service Class. If a device is not listed in the DICOM AE Security Matrix, it cannot access the VistA system or its components.

VistA Imaging system administrators use the menu option Configure AE Security Matrix Settings [MAGV AE SEC MX SETTINGS] after initial installation to define the remote devices that can connect to the local VistA system and its components. They will also use the menu option to remove devices, or to change device properties.

The Configure AE Security Matrix Settings [MAGV AE SEC MX SETTINGS] menu option is accessed from the Imaging System Manager Menu [MAG SYS MENU].

```
HL7  Imaging HL7 Messaging Maintenance ...
IX   Image Index Conversion Menu ...
LS   Edit Network Location STATUS
TR   Telereader Menu ...
     Ad hoc Enterprise Site Report
     Configure AE Security Matrix Settings
     Delete Image Group
     Delete Study by Accession Number
     DICOM Menu Options ...
     Enter/edit Reason
     Imaging Database Integrity Checker Menu ...
     Imaging Site Reports ...
     Importer Menu ...
```

For information about the AE Security Matrix and about using the Configure AE Security Matrix Settings to configure the AE Security Matrix, see the *VistA Imaging DICOM Gateway Installation Guide*.

8.4 Delete Study by Accession Number [MAG SYS-DELETE STUDY]

This menu allows a user with the MAG DELETE key to delete studies by accession number. In the data structures introduced in MAG*3.0*34, each study has a different accession number. The Delete Study by Accession Number is useful for deleting studies from the new data structures. For deleting studies from the old data structures, you can still use the Delete Image Group option. This option deletes all images in the group, regardless if they are in the new or in the old data structures.

The [MAG SYS-DELETE STUDY] menu option is accessed from the Imaging System Manager Menu [MAG SYS MENU].

```

HL7  Imaging HL7 Messaging Maintenance ...
IX   Image Index Conversion Menu ...
LS   Edit Network Location STATUS
TR   Telereader Menu ...
    Ad hoc Enterprise Site Report
    Configure AE Security Matrix Settings
    Delete Image Group
    Delete Study by Accession Number
    DICOM Menu Options ...
    Enter/edit Reason
    Hybrid DICOM Gateway Menu ...
    Imaging Database Integrity Checker Menu ...
    Imaging Site Reports ...
    Importer Menu ...
  
```

To delete a study by accession number:

1. From the Imaging System Manager Menu, select **Delete Study by Accession Number**:

```
Select Imaging System Manager Menu Option: Delete Study by Accession Number
```

2. Enter the accession number of the study you want to delete.

```
Enter an Accession Number: GMRC-123
```

3. Select a reason for deleting the study.

```
Information on Study(ies) to be deleted for accession number GMRC-123:
```

```
-----
PATIENT: PATIENT,ONEZEROZEROSIX SSN: 000-00-1006   DOB: FEB 23,1948
PROCEDURE: OPHTHALMOLOGY
STUDIES: 1   SERIES: 2   IMAGES: 2
```

```
1 Low quality image
2 Wrong case/exam/accession number
3 Wrong note title
4 Wrong patient
5 All images were removed from the group
6 HIMS document correction
```

```
Select a reason for deletion: (1-6): 4
```

4. Type **Yes** to confirm you want to delete the study.

```
ARE YOU SURE YOU WANT TO DELETE STUDIES FOR ACCESSION #: GMRC-123? NO// YES
```

The system displays a message that the study has been deleted. The study is marked for deletion in the database. It will no longer be available for viewing, queries or any other operations.

```
Deletion successfully completed!
```

8.5 Enter/Edit Reason [MAG REASON EDIT]

This menu option allows adding/editing of reasons for actions performed on images (copying, printing, etc.) stored in the MAG REASON file (#2005.88). The Reason codes and definitions shown are samples only.

```
HL7   Imaging HL7 Messaging Maintenance ...
IX    Image Index Conversion Menu ...
LS    Edit Network Location STATUS
TR    Telereader Menu ...
      Ad hoc Enterprise Site Report
      Configure AE Security Matrix Settings
      Delete Image Group
      Delete Study by Accession Number
      DICOM Menu Options ...
      Enter/edit Reason
      Imaging Database Integrity Checker Menu ...
      Imaging Site Reports ...
      Importer Menu ...
```

From the System Manager menu [MAG SYS MENU] select **Enter/edit Reason**.

```
Select Imaging System Manager Menu Option: Enter/edit Reason
```

At the prompt **Select MAG REASON:** enter a reason number to display an existing reason; or a **?** to display a list of all MAG REASON numbers currently stored.

```
Select MAG REASON: ?
Answer with MAG REASON, or NUMBER, or CODE
Do you want the entire 13-Entry MAG REASON List? yes (Yes)
Choose from:
1      Clinical care for the patient whose images are being downloaded
1 -Copy-Print-
2      Clinical care for other VA patients 2 -Copy-Print-
3      For use in approved research by VA staff 3 -Copy-Print-
4      For approved teaching purposes by VA staff 4 -Copy-Print-
5      For use in approved VA publications 5 -Copy-Print-
6      Authorized release of medical records or health information (ROI
) 6 -Copy-Print-
7      Corrupt image 7 -Delete-
8      Low quality image 8 -Delete-Status-
9      Wrong case/exam/accession number 9 -Delete-Status-
10     Wrong note title 10 -Delete-
11     Wrong patient 11 -Delete-
12     Image is incorrectly included in an image group 12 -Status-
13     All images were removed from the group 13 -Delete-
```

You may enter a new MAG REASON, if you wish
Answer must be 3-70 characters in length.

A new MAG REASON is added by entering the name of a new MAG REASON at the prompt.

```
Select MAG REASON: Reference
Are you adding 'Reference' as a new MAG REASON (the 14TH)? No// yes (Yes)
MAG REASON CODE: L14// To refer to the patient image as reference material.
?
Enter unique code of the reason (from 1 to 999999). Codes of local reasons
must be preceded by letter L.
MAG REASON CODE: L14// L14
REASON: Reference//
```

Because new MAG REASON codes can be created either by the national VistA team, or by local site administrators, the MAG REASON code list varies from site to site. In some cases, the same reason appears on different site lists with different code numbers. For example, the latest nationally created reason—For use in Veterans Benefits Administration claims processing, which was created as part of the VIX maintenance Patch 124—is number 16 on the list of nationally created reasons. But if a site used the 16th place in its MAG REASON code list for a local reason before Patch 124, that local reason appears as L16 on that site’s MAG REASON list, and the new national code takes the next number in line. In that hypothetical case, For use in Veterans Benefits Administration claims processing would appear as code 17 on the site’s MAG REASON list.

The national MAG Reason Code list now contains 16 codes (see table). It contained 15 reason codes before site administrators were given the capability to create local reason codes. These 15 reasons are uniform across all VistA sites.

Number	Reason	Type	Code
1	Clinical care for the patient whose images are being downloaded	CP	1
2	Clinical care for other VA patients	CP	2
3	For use in approved research by VA staff	CP	3
4	For approved teaching purposes by VA staff	CP	4
5	For use in approved VA publications	CP	5
6	Authorized release of medical records or health information (ROI)	CP	6
7	Corrupt image	D	7
8	Low quality image	DS	8
9	Wrong case/exam/accession number	DS	9
10	Wrong note title	D	10
11	Wrong patient	D	11
12	Image is incorrectly included in an image group	D	12
13	All images were removed from the group	D	13

Number	Reason	Type	Code
14	HIMS document correction When a document or image needs to have the patient or image data corrected	DS	14
15	Rescinded TIU Note	SD	15
16	For use in Veterans Benefits Administration claims processing.	CP	16

Note: The transaction log/report lists actions on images by type and reason. For an accurate understanding of the logs from any VA site, complete the steps in the first two paragraphs of this section to retrieve a list of all MAG REASON codes currently being used at the site. Locate the MAG REASON number on the site list. Each MAG REASON number on this list is paired with the text of the reason for the action.

8.6 MAG Client Version Report [MAG CLIENT VERSION REPORT]

Imaging Clients Version Report [MAG CLIENT VERSION REPORT]-This option prints the list of workstations and clients that need updates. When the new version of the VistA server code is distributed, those clients may continue, but they are not supported.

From the Imaging System Menu [MAG SYS MENU], enter "Imaging Site Reports" at the prompt.

```

HL7   Imaging HL7 Messaging Maintenance ...
IX    Image Index Conversion Menu ...
LS    Edit Network Location STATUS
TR    Telereader Menu ...
      Ad hoc Enterprise Site Report
      Configure AE Security Matrix Settings
      Delete Image Group
      Delete Study by Accession Number
      DICOM Menu Options
      Enter/edit Reason
      Hybrid DICOM Gateway Menu ...
      Imaging Database Integrity Checker Menu ...
      Imaging Site Reports ...
      Importer Menu ...

Select Imaging System Manager Menu Option: Imaging Site Reports
    
```

At the prompt, enter "Imaging Clients Version Report".

```

Select Imaging Site Reports <TEST ACCOUNT> Option: Imaging Clients Version Report
Last login date is within this many days: (1-9999): 30// 9999 <CR>
Workstation name contains text: <CR>
Include all workstations in the report? N// y YES

      Select one of the following:

          V      Site-Client-Version-Workstation Name
          W      Site-Workstation Name-Client

Report Sort Mode: W// v Site-Client-Version-Workstation Name
    
```

```

DEVICE: HOME// <CR> TELNET

                LIST OF ALL WORKSTATIONS AND CLIENTS
                LAST LOGIN DATE: Aug 05, 1985
                =====
Client          Client Version  Workstation Name          Client   Last
-----          -
DISPLAY        3.0.33.12      YOUR-CB8E6AA16C          04/14/04 09/02/04
VISTARAD       3.0.41.17      isw-imglab2              06/01/04
               isw-imgvrad-xp1         05/20/04
               va-vrad-xp-2           06/02/04
CAPTURE        *3.0.106.13    ISW-FRANKS2-LT          02/28/11 07/24/12

[...]

Workstation(s) found: 172
Workstation(s) to be updated: 166

```

8.7 Imaging VistARad System Options

The VistARad System Options Menu is used to set site parameters that control VistARad's basic behaviors and performance, to create custom exam lists, and to review and manage VistARad's prefetch and CPT (Current Procedural Terminology) code matching capabilities.

Menu Diagram for MAGJ MAIN

```

Select OPTION NAME: MAGJ MAIN      VistARad System Options

SITP  E/E VistaRad Site Parameters
ELIS  E/E VistaRad Exam Lists
PLIS  Print VistaRad List Definition
EPRF  E/E VistaRad PreFetch Logic
IPRF  Inquire Prefetch Logic
PPRF  Print VistaRad Prefetch Logic Table
ECPT  E/E VistaRad CPT Matching Set
ICPT  Inquire VistaRad CPT Matching Set
PCPT  Print VistaRad CPT Matching Logic Table
EPRO  E/E VistARad Default User Profiles

```

8.8 Imaging MAG WINDOWS Menu Option

The menu option MAG WINDOWS should be assigned as a secondary menu option to end-users who need access to VistA Imaging, and to all users and operators of the DICOM Gateways and Background Processor applications. This menu outlines enables:

- Access to all the RPCs used by VistA Imaging
- An automated log-on to applications experiencing service interrupted by network and host system outages

8.9 Imaging VistARad MAGJ VISTARAD WINDOWS

The menu option MAGJ VISTARAD WINDOWS should be assigned as a secondary menu option to end-users who need access to VistA Imaging VistARad. This menu outlines all the RPCs used by VistARad.

8.10 Imaging MAG JB OFFLINE Menu option

This menu option is not part of any menu and is discussed in Chapter 9 of this manual; section Removing Jukebox Media - Offline Images.

8.11 Imaging DICOM Menu

The VistA Imaging DICOM Gateway itself does not use VA Kernel software, and as a result, does not use any Options. However, on the VistA hospital system the following menu does relate to the DICOM Gateways. See the *Imaging DICOM User Manual* for full instructions on using this menu.

Menu Diagram for MAGD DICOM MENU

```
Select Dicom Menu Options Option: [MAGD DICOM MENU]

  ECTP Edit CT PARAMETER File [MAGD CT PARAMETER EDIT]
  ICTP Display MAGD CT PARAMETER entries [MAGD CT PARAMETER INQUIRY]
  ECRP Edit CR PARAMETER File [MAGD CR PARAMETER EDIT]
  ICRP Display MAGD CR PARAMETER entries [MAGD CR PARAMETER INQUIRY]
  Correct Clinical Specialities DICOM File Entries [MAGD FIX CLINSPEC DICOM FILE]
  Correct RAD-DICOM File Entries [MAGD FIX DICOM FILE]
  Clean Up DICOM Gateway (DICOM Destinations) [MAGD REMOVE GATEWAY XMIT]
  Clean Up DICOM Gateway (Failed Images) [MAGD REMOVE GATEWAY FAILED]
  List Unread Studies [MAGD LIST UNREAD STUDIES]
  Print Dicom Failed Image File Entries [MAGD PRINT DICOM FILE]
  Rename DICOM Gateway (DICOM Destinations) [MAGD RENAME GATEWAY XMIT]
  Rename DICOM Gateway (Failed Images) [MAGD RENAME GATEWAY FAILED]
  Validate DICOM Correct Information [MAG DICOM CORRECT VALIDATE]

Select Dicom Menu Options Option:
```

8.12 Imaging Menu Options Documentation

A full description for all of the Imaging's VistA menu options can be obtained by using FileMan print menu option.

```
Select OPTION: print FILE ENTRIES

OUTPUT FROM WHAT FILE: OPTION//
SORT BY: NAME//
START WITH NAME: FIRST// MAG
GO TO NAME: LAST// MAGZ
  WITHIN NAME, SORT BY:
FIRST PRINT FIELD: [CAPTIONED

Include COMPUTED fields: (N/Y/R/B): NO// - No record number (IEN), no Computed
  Fields
DISPLAY AUDIT TRAIL? No// NO
Heading (S/C): OPTION LIST//
START AT PAGE: 1//
DEVICE:
```

8.13 Access to DICOM Gateway RPCs

The VistA system grants access to Remote Procedures based on a relation between certain menu options and the RPCs in question. The DICOM Gateway uses two classes of RPCs: those that can be called by any user of the DICOM Gateway (“view-only access”) and those that can only be called by end-users with “full access”. In order to support this distribution of privileges, the

following two menu options are present in the VistA system and should be assigned to the appropriate personnel:

MAG DICOM GATEWAY VIEW
MAG DICOM GATEWAY FULL

8.14 Imaging Menu Options Documentation

A full description for all of the Imaging VistA menu options can be obtained by using the FileMan print menu option.

```
Select OPTION: print FILE ENTRIES
OUTPUT FROM WHAT FILE: OPTION//
SORT BY: NAME//
START WITH NAME: FIRST// MAG
GO TO NAME: LAST// MAGZ
                               WITHIN NAME, SORT BY:
FIRST PRINT FIELD: [CAPTIONED

Include COMPUTER fields: (N/Y/R/B): NO// - No record number (IEN),
no Computed Fields
DISPLAY AUDIT TRAIL? No// NO
Heading (S/C): OPTION LIST//
START AT PAGE: 1//
DEVICE:
```

Note: The output displayed by the option, Inquire VistARad CPT Matching Set [MAGJ INQUIRE CPT MATCHING SET], has been modified to display attributes defined for the entered CPT code, and also the matching CPT code values for its related "Similar CPT" and "Modality/Body Part" combinations.

Note: This change as implemented does not require any KIDS component, so no new or modified Menu options will be apparent in the KIDS definition or installation files.

This page is intentionally blank.

Chapter 9 Archiving, Purging, Verifying, and Backup

9.1 Introduction

This chapter explains how to archive, purge, and verify VistA Imaging files and VistA Imaging FileMan entries. Image files are part of the patient's record and must be preserved for the required number of years. Image files may be kept online indefinitely. As image files get older and have not been accessed recently, they reside on the optical disk jukeboxes where they are still accessible to users, but access is less rapid. Some sites have taken platters out of jukeboxes for shelf storage, but these are reloaded when needed by a user. The state of the images on the storage devices and their relationship (through file references) to the VistA database require periodic verification.

Most of the information in this chapter describes archiving, purging, and backup using the Background Processor and refers to the data that is stored in the data structures that were used before MAG*3.0*34 (also referred to as the "old" data structures). This data includes the SOP classes that were supported before MAG*3.0*34.

DICOM objects and studies from the SOP classes for which support was introduced in MAG*3.0*34 are stored in the data structures that were introduced in MAG*3.0*34 (also referred to as the "new" data structures). The Archiver, which is installed with the HDIG, manages the archiving and data aging in the new data structures. For information about handling processing and storage errors in the new data structures, see section *11.4 Handling Processing and Storage Errors in the New Data Structures*.

9.2 Archiving and Purging of Image FileMan Entries

Entries in the IMAGE file (#2005) should **not** be purged or archived.

9.3 Archiving and Purging of Image Files

9.3.1 Automatic Image File Migration

The imaging workstation stores the full-size image file on the server when the image is captured. An abstract may be created by the capture workstation, or by placing an entry in the Abstract queue. An entry is placed in the JUKEBOX queue. The background processor then copies the images to Tier 2.

After a period of time during which an image is not accessed:

1. The full-size image will be deleted from the magnetic file server. It will still be accessible to users from Tier 2.
2. Next, the abstract will be deleted from the magnetic file server. If a subsequent request is made to display the full-size image or the abstract, that file will be copied back to the magnetic file server.

Because images are stored temporarily on the magnetic servers, these are referred to as VistA magnetic cache.

9.3.2 Purging Tier 1 Shares

The Background Processor's Purge application clears disk space within the VistA Imaging shares. This space is necessary for newly captured files from Imaging modalities and the DICOM gateways. Space is also needed for files that are copied from Tier 2 when images are viewed on Imaging display workstations.

Each file on every VistA Imaging shares is evaluated to determine if it should be purged, as follows:

- The file name must consist of the local namespace followed by the number which coincides with its IMAGE file (#2005) internal entry number. If the corresponding IMAGE file (#2005) entry does not exist, the image file is unconditionally purged from the VistA Imaging shares.
- The file location is checked against the IMAGE file (#2005) settings. If the IMAGE file (#2005) entry has no current magnetic cache pointers set for this image, then the IMAGE file (#2005) entry is updated, and the file is not purged. If no Tier 2 pointer is set, then a Tier 2 copy (JUKEBOX queue) is queued.
- If the image file in the VistA Imaging shares is not where the IMAGE file (#2005) specifies it to be, then the location pointed to by the IMAGE file (#2005) is checked. If a proper image file is found, then the redundant image will be otherwise purged.
- The image is next characterized as Patient Photo or non-Photo image for a patient by checking its image type. If so, the Photo ID/Advance Directive's purge criteria parameters will be used in evaluating this image.
- If the image (a) is found to be at a Tier 1 location other than that specified by the IMAGE file (#2005) entry, or (b) is not found at an IMAGE file (#2005) alternate site, or (c) is confirmed of size non-zero on Tier 2, then the file will be removed from the VistA Imaging Tier 1 according to the purge criteria.

9.4 Queue Management

Failed and unprocessed queues are purged during the install procedures of the VistA Imaging System. Using the BP Edit|Queue Manager| *Queue Type* option on the main Background Processor form, one can update and manage queue file growth. After selecting a queue type and a queue status value, a list of the queues from eldest to most current will be shown with their status. The list will end at the current queue pointer. These reflect unprocessed (nil) and failed queues.

The user has the option of requeuing, purging or saving them to a file. These records reflect requests to move files to and from Tier 2 with the exception of Abstract and Delete queues

Normally, a site would not consider requeuing jukebox-to-hard disk copies (JBTOHD queue) as these files usually reflect old requests that, for the most part, will no longer be useful. The Tier 2 copies (JUKEBOX queue) may be requeued, however, the Purge process will automatically requeue those that are not currently archived on Tier 2

Each queue task has an active queue pointer that designates the next entry to be processed. This queue pointer can be manually moved forward to begin processing at another location in the

queue by using the Set Queue Partition context menu option within the BP Queue Manager. A typical situation may be when a queue entry is corrupted. Then the active queue pointer can be moved to the next entry where processing will continue with the rest of the queue entries for that task. (See the *Background Processor User Manual* for more details).

9.4.1 Server Size

1. Select **View | Server Size** from the BP Queue Processor menu bar.

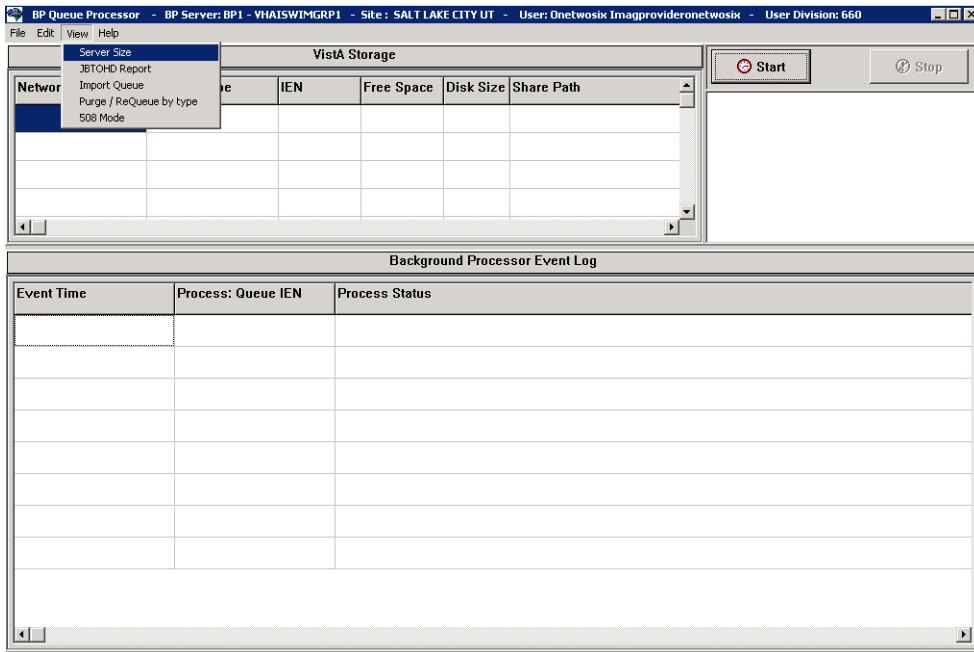

This window shows the amount of total space, free space and % Server Reserve space for Tier 1 and Tier 2 shares as well as RAID Groups.

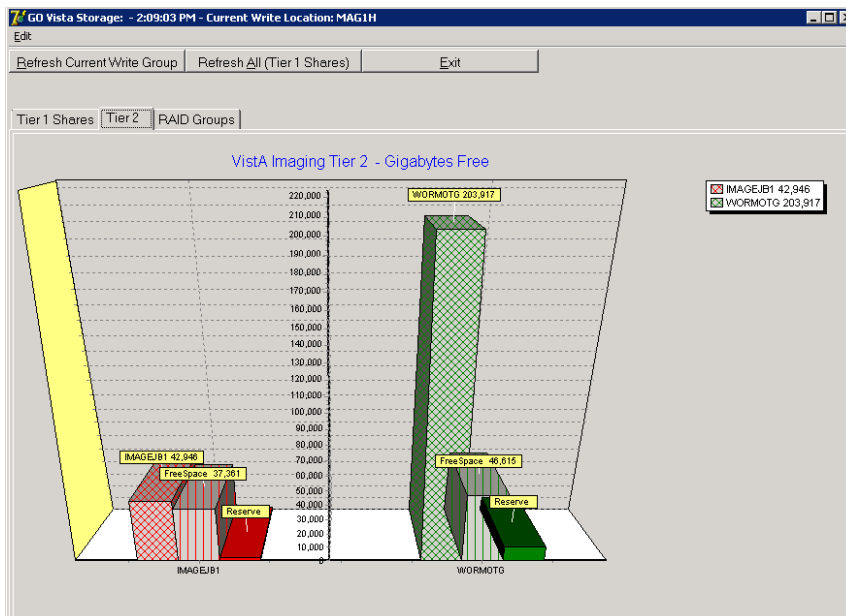

The VistA Storage area on the Queue Processor GUI can be refreshed with the most current storage utilization statistics for RAID Groups and Tier 1 shares by clicking the buttons **Refresh Current Write Group** or **Refresh All (Tier 1 Shares)**.

9.4.2 Background Processor: Open Log Functions

Log Files

New log files are created as HTML files at the beginning of every session. HTML files are viewable, printable, and searchable. By default, the BP Queue Processor log files reside in the following subdirectories:

- Queue Processor - C:\Program Files\VistA\Imaging\BackProc\log\BackProc
- Purge - C:\Program Files\VistA\Imaging\BackProc\log\purge
- Verifier - C:\Program Files\VistA\Imaging\BackProc\log\verifier

You can access these files by selecting **File | Open Log** on the BP Queue Processor menu bar and double-clicking the desired file.

Note: The log files can also be imported into an Excel spreadsheet.

Important: These files should be kept for historical/troubleshooting reasons and added to the tape backup process to safeguard the files. (See *Appendix B: Backups* in the *VistA Imaging System Installation Guide*.)

Log File Format

BP Queue Processor log files are archived as HTML files and have the year-month-day and sequence number imbedded in the file name, as shown in the right pane of the window in this example.

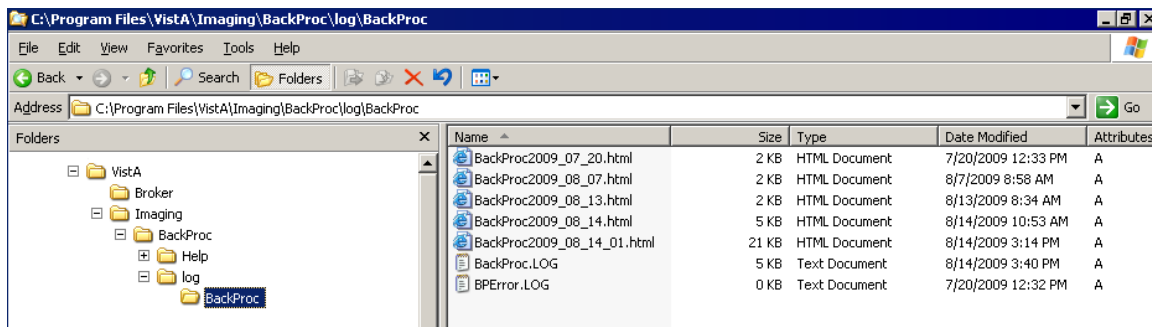

If more than one log file is created on the same day, the system appends a sequence number to the file name.

Queue Processor Log Files

The Queue Processor produces multiple log files for a processing run. Each file contains different information.

- BackProc Log

The BackProc.log file records all activity in the Event Log section in the Queue Processor window.

Date/Time	Event_Queue_Ref	Message/Path
10/29/2009 12:30:52 PM	BP Version	30.1.39.21
10/29/2009 12:30:52 PM	BP OS	Win Server 5.2.3790
10/29/2009 12:30:52 PM	Work Station	VHAI5WVHTEVM2
10/29/2009 12:30:52 PM	Vista Imaging Install	3.0P39
10/29/2009 12:30:52 PM	Vista BrokerServer	vhai5wvhtevm1
10/29/2009 12:30:52 PM	Raid Verify	Checking File Server Space
10/29/2009 12:30:54 PM	JukeBox:CacheSize	JBCache Percent Space Available: 98
10/29/2009 12:30:54 PM	Jukebox: 294	WVHAI5WVHTEVM1\IMAGE\1\$NDM00111D\M001167.TGA WVHAI5WVHTEVM1\IMAGE\EJB\1\$1D\M001167.TGA
10/29/2009 12:30:55 PM	Jukebox: 294	Jukebox copy not overwritten.
10/29/2009 12:30:55 PM	JUKEBOX: 294	WVHAI5WVHTEVM1\IMAGE\1\$NDM00111D\M001167.TXT WVHAI5WVHTEVM1\IMAGE\EJB\1\$1D\M001167.TXT
10/29/2009 12:30:55 PM	JUKEBOX: 294	TXN Not copied.
10/29/2009 12:30:55 PM	Jukebox: 294	WVHAI5WVHTEVM1\IMAGE\1\$NDM00111D\M001167.ABS WVHAI5WVHTEVM1\IMAGE\EJB\1\$1D\M001167.ABS
10/29/2009 12:30:55 PM	Jukebox: 294	Jukebox copy not overwritten.
10/29/2009 12:30:55 PM	JUKEBOX:294	
10/29/2009 12:30:55 PM	% Server Reserve	Low Water Mark: % Free Space: 17.98%
10/29/2009 12:30:55 PM	JukeBox:CacheSize	JBCache Percent Space Available: 98
10/29/2009 12:30:55 PM	Jukebox: 295	WVHAI5WVHTEVM1\IMAGE\1\$NDM00111D\M001168.TGA WVHAI5WVHTEVM1\IMAGE\EJB\1\$1D\M001168.TGA
10/29/2009 12:30:55 PM	Jukebox: 295	Jukebox copy not overwritten.
10/29/2009 12:30:55 PM	JUKEBOX: 295	WVHAI5WVHTEVM1\IMAGE\1\$NDM00111D\M001168.TXT WVHAI5WVHTEVM1\IMAGE\EJB\1\$1D\M001168.TXT
10/29/2009 12:30:55 PM	JUKEBOX: 295	TXN Not copied.
10/29/2009 12:30:55 PM	Jukebox: 295	WVHAI5WVHTEVM1\IMAGE\1\$NDM00111D\M001168.ABS WVHAI5WVHTEVM1\IMAGE\EJB\1\$1D\M001168.ABS
10/29/2009 12:30:55 PM	Jukebox: 295	Jukebox copy not overwritten.

Name	Description
Date/Time	Actual time when the IMAGE file (#2005) was processed
Event_Queue_Ref	Queue name and entry number and status check info
Message/Path	Description of action taken (or statistics for status checks)

- BP Error Log

The BPErrors.log file records error conditions with the operating system and Broker.

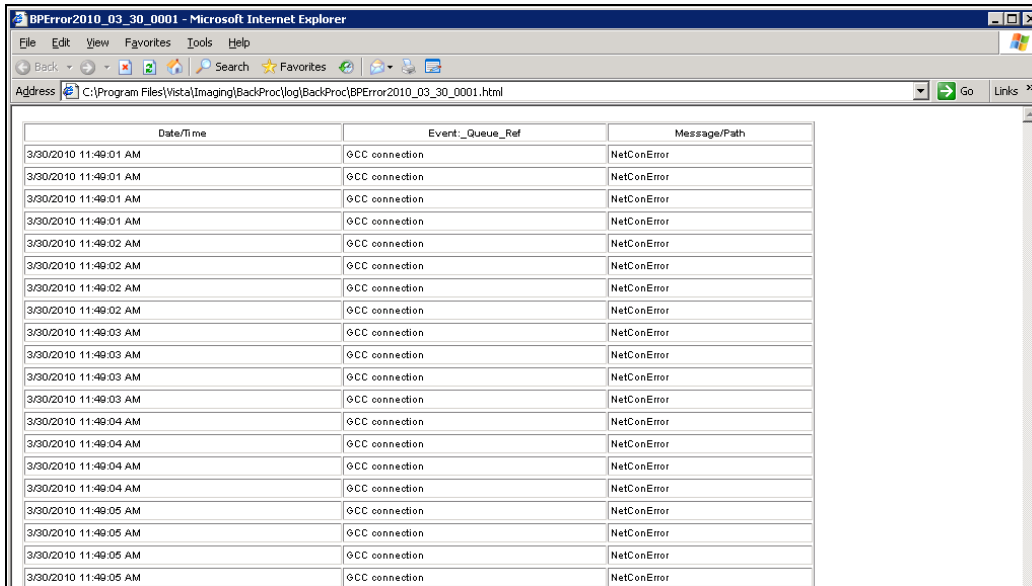

Date/Time	Event_Queue_Ref	Message/Path
3/30/2010 11:49:01 AM	GCC connection	NetConError
3/30/2010 11:49:01 AM	GCC connection	NetConError
3/30/2010 11:49:01 AM	GCC connection	NetConError
3/30/2010 11:49:01 AM	GCC connection	NetConError
3/30/2010 11:49:02 AM	GCC connection	NetConError
3/30/2010 11:49:02 AM	GCC connection	NetConError
3/30/2010 11:49:02 AM	GCC connection	NetConError
3/30/2010 11:49:02 AM	GCC connection	NetConError
3/30/2010 11:49:03 AM	GCC connection	NetConError
3/30/2010 11:49:03 AM	GCC connection	NetConError
3/30/2010 11:49:03 AM	GCC connection	NetConError
3/30/2010 11:49:03 AM	GCC connection	NetConError
3/30/2010 11:49:04 AM	GCC connection	NetConError
3/30/2010 11:49:04 AM	GCC connection	NetConError
3/30/2010 11:49:04 AM	GCC connection	NetConError
3/30/2010 11:49:04 AM	GCC connection	NetConError
3/30/2010 11:49:05 AM	GCC connection	NetConError
3/30/2010 11:49:05 AM	GCC connection	NetConError
3/30/2010 11:49:05 AM	GCC connection	NetConError
3/30/2010 11:49:05 AM	GCC connection	NetConError

Name	Description
Date/Time	Actual time when the IMAGE file (#2005) was processed
Event_Queue_Ref	Error category
Message/Path	Description of error condition

Verifier Log Files

BP Verifier produces the following types of log files. For details on each log file, see the Verifier chapter in the *Background Processor User Manual*.

- Scan Log

The Scan log file lists entries with potential file integrity problems. The log records the operational events that take place to correct a particular problem. They are used to determine if and how the Verifier corrected the faulty condition. The IENs that the Verifier could not fix are listed in the ScanError log file.

- NoArchive Log

The NoArchive log file contains image file names that are missing on the jukebox and could not be created from existing files and/or could not be found on the RAID. The Verifier examines both the IMAGE file (#2005) and the IMAGE AUDIT file (#2005.1) for missing files. The 2005.1 column shown below indicates those missing files that have been deleted and the IMAGE file (#2005) record has been moved to the IMAGE AUDIT file (#2005.1).

- **ScanError Log**
The ScanError log file lists problems with IENs that could not be corrected. When a Verifier scan is completed, the contents of this file are sent as a mail message to the MAG SERVER mail group.
- **DFNError Log**
The DFNError log file displays integrity issues with patient data.
- **VerfierdebugLog**
The Verifier debug information is only logged when an error occurs. After 30 errors, debug mode is turned off. By turning off debug mode, the size of the Debug Log is restricted to limit overwhelming the local hard drive with repetitive data.

Purge Log Files

BP Purge produces the following types of log files. For details on each log file, see the Purge chapter in the Background Processor User Manual.

- **Purge Log**
The Purge.html log file records the current share being purged as well as all of the successful deletions and the reason they were deleted.
- **PurgeError Log**
The PurgeError.html log file records the current share being purged as well as all of the files that were not deleted and the reason they were not deleted.

9.4.3 Check Status of the JBTOHD Report

1. On the Background Processor main menu, select the **View | JBTOHD Report** option.
2. Select **File | Refresh** in the report window.

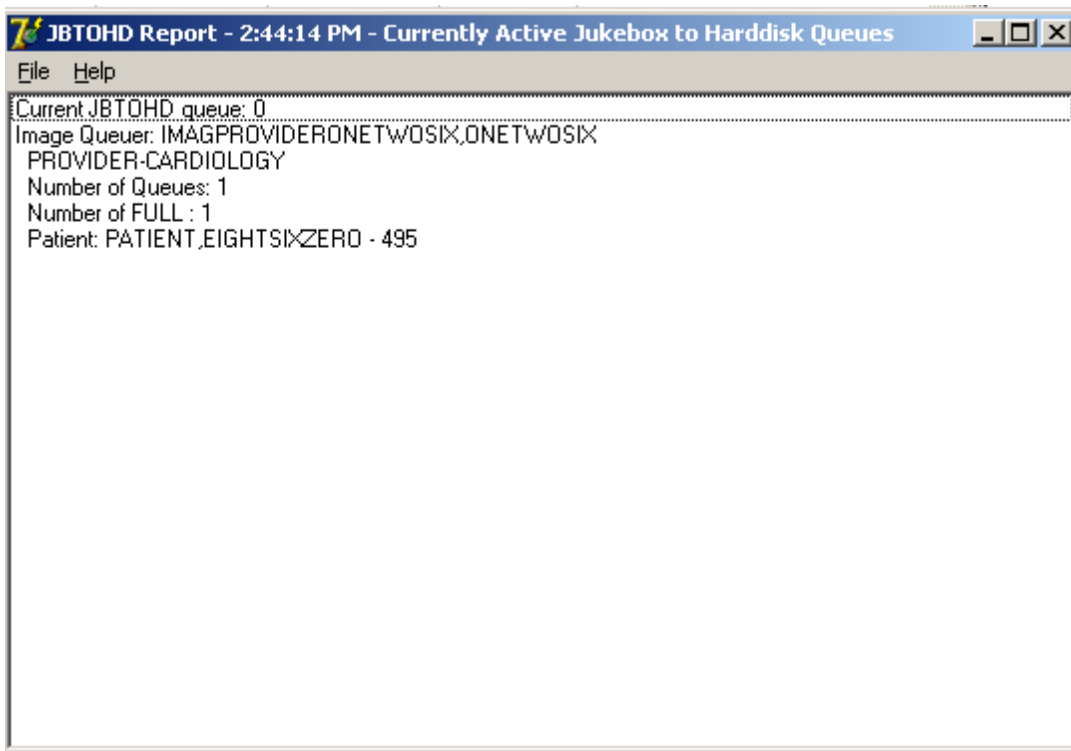

The JBTOHD queue display is sorted by the individual that queued the entry. It displays the number and types of queues. It displays the patient along with the queue Internal Entry Number (IEN) to facilitate advancing the queue pointer.

9.5 Background Processor Configuration Tools

9.5.1 Configuring BP Servers

Guidelines

- At least one BP Server must be present to perform utility functions such as copying image files to and from Imaging servers (the Tier 1 shares) and Tier 2.
- The software does not permit redundant task assignments of BP activities. For example, you cannot specify that more than one BP Server perform the JUKEBOX queue task.
- The JUKEBOX and DELETE queue tasks should run on the same BP server. If not, the DELETE queue may be processed in advance of the image being written to the Tier 2, and the DELETE queue will eventually fail. These failed queues must be re-queued.
- The IMPORT and ABSTRACT tasks must run on the same server. There will be occasional archived FULL files that do not have abstracts. If you see these ABSTRACT tasks failing, the JBTOHD task should be added to server running the IMPORT/ABSTRACT task. Please note the IMPORT can execute on a single server.

- If the Verifier and Purge are to be run on servers other than those running the Queue Processor tasks, a new BP Server must be configured for those tasks.
- When the PREFET task is added to the VistA Imaging Display workstation configuration, this activity task must be checked assigned on the BP Server configuration window in order to have these queue types processed.
- A directory can be created on the Tier 1 shares or remote storage location to archive BP log files for later reference.

Adding a BP Server to the VistA Imaging System

Running multiple BP servers improves performance and redundancy by allowing the distribution of tasks, and allowing queues to be quickly reassigned in the event of a failure. Therefore, it is recommended that at least two BP servers be up and running. Though the facility may choose any server to host the BP (as long as the server meets the minimum requirements), an ideal location is directly on the two Image Cluster nodes.

To Set Up a BP Server Application

1. From the BP Queue Processor menu bar, select **Edit | BP Servers**.

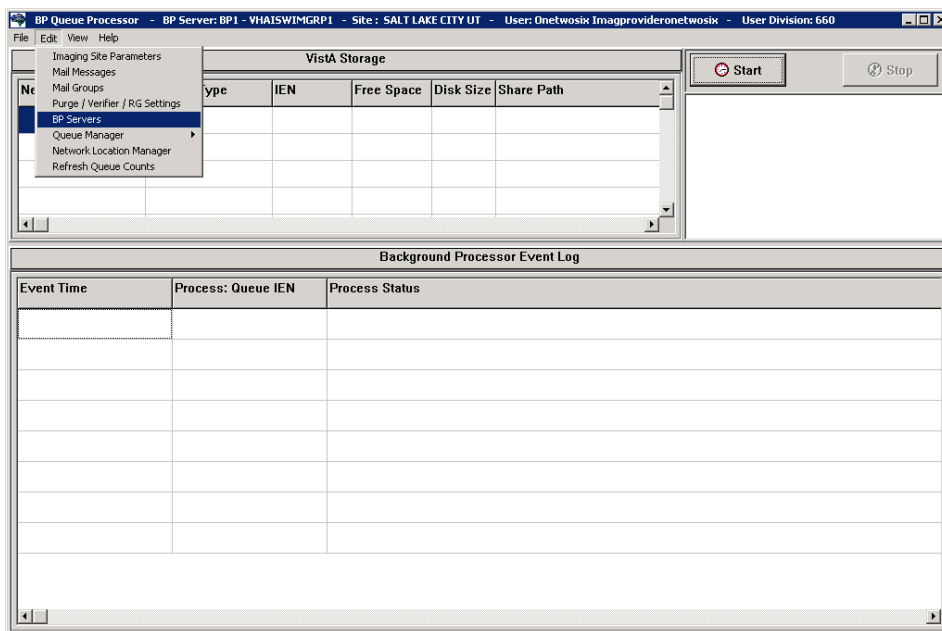

The BP Server Parameters window enables you to create a unique server name for a server and assign tasks to that server. The properties on these servers enable you to specify the location of the log files for all applications on each BP Server and the file's size limit (described in “*Specifying the Log File Location and Size*” in the *BP User Manual*.)

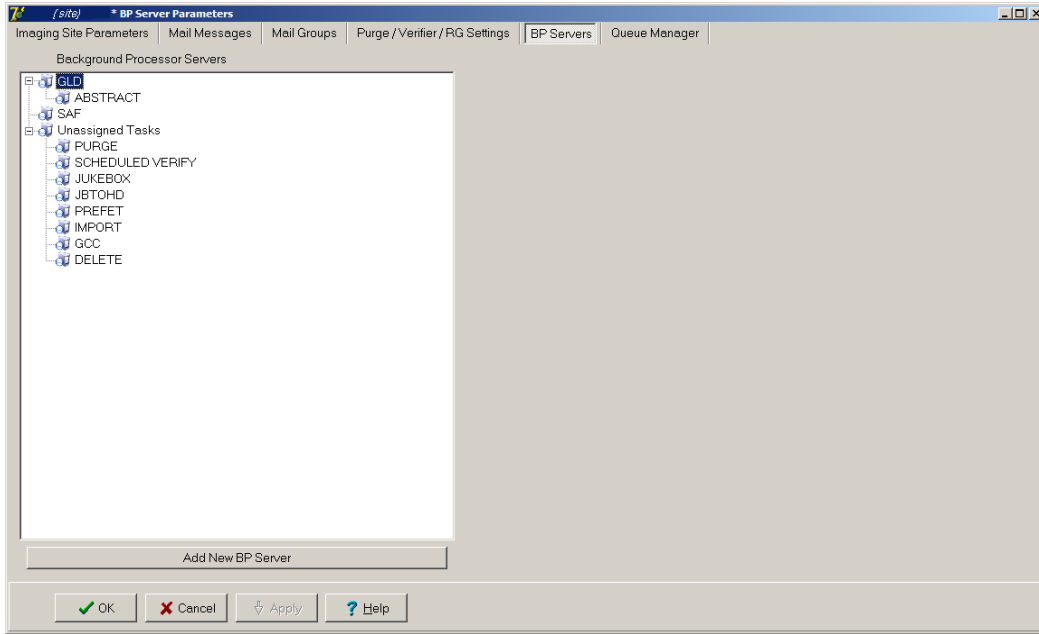

2. Click the **Add New BP Server** button at the bottom of the tree pane.
3. In the BP Server Add dialog box displayed, enter a logical name for the BP Server such as **BP1**.

Note: The name must be at least three characters in length and can contain alpha and numeric characters and must be unique. Once the name is saved, it cannot be renamed. It can only be deleted when all the tasks assigned to it are removed.

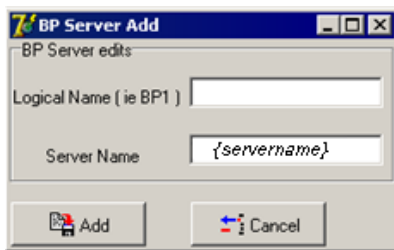

If the name is not valid, an error message is displayed. You can correct the name and repeat the steps.

Assigning Tasks (Queues) to a BP Server

By default, no tasks are assigned to BP Servers. The tasks will need to be assigned in order for that function of the BP software to operate. You can assign tasks based on the needs of your facility. As previously mentioned, a queue name identifies the task that the Queue Processor performs. All queues are available for you to assign to a BP Server, except EVAL.

Note: You should assign Purge as well as the Scheduled Verify to BP Servers. These features help maintain the system's free-space and integrity without operator intervention.

1. Drag and drop a task from the Unassigned Tasks in the tree pane (shown) to the server that is designated to run that task.

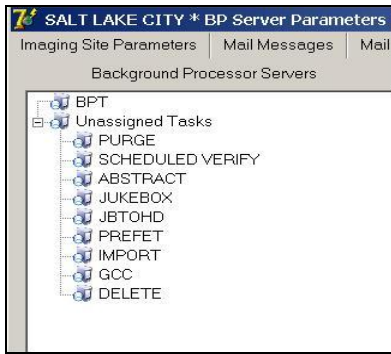

Note: The priority of tasks running on the same server is set internally and cannot be changed. The functions of each task are:

- 1) JBTOHD - populates the Tier 1 shares with images that have been deleted from Tier 1 through the Purge function.
 - 2) PREFET - populates Tier 1 with images that were requested based on VistA Imaging Display workstation configuration parameters.
 - 3) ABSTRACT - creates ABS derivative thumbnail files from FULL/BIG files when the file type is missing on Tier 1 and Tier 2.
 - 4) IMPORT - provides a means for external applications to archive images in the VistA Imaging environment.
 - 5) JUKEBOX - copies images to the long-term archival storage device
 - 6) DELETE - removes images from Tier 1.
 - 7) GCC - exports images to a share that is external to the local VistA Imaging network.
 - 8) PURGE – This assignment includes both the auto purge and the scheduled purge tasks. Refer to the purge section of this document for more details.
 - 9) SCHEDULED VERIFY – automatically runs the Verifier at the assigned time to check the integrity of the Image records in VistA with the file locations on Tier 1 and Tier 2 storage. Only the most recent unchecked IENs are verified.
2. Click **Apply** to save the changes or **OK** to save the changes and exit.

Removing a BP Server from the VistA Imaging System

1. From the Queue Processor menu bar, select Edit | BP Servers.
2. In the tree pane, right-click the server name and select Delete BP Server from the popup menu displayed.

Note: This popup menu can also be accessed from the keyboard by using Shift + F10.

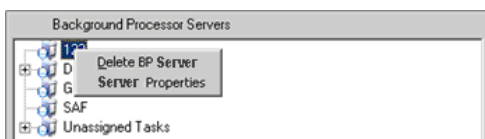

The selected BP Server is removed from the tree pane.

Note: This same name can be added later.

Specifying the Log File Location and Size

1. Click a BP Server name in the tree pane and select Server Properties from the popup menu displayed.

Note: This popup menu can also be accessed from the keyboard by using Shift + F10.



The BP Server Properties dialog box is displayed.

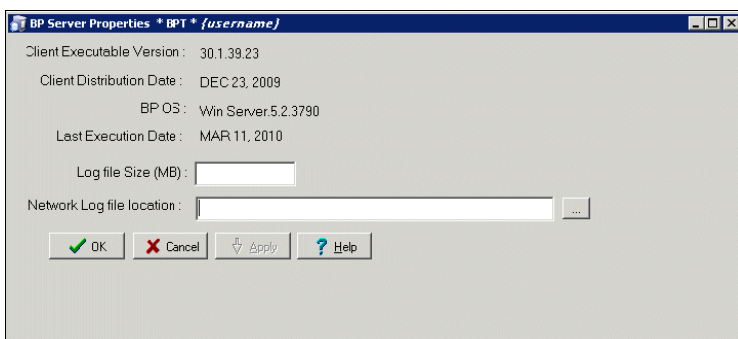

2. Enter the size in megabytes in the Log File Size field.
The default log file size limit is 2 MB.
3. Specify the Network Log file location on a local machine or a remote network location.

Note: By default, the log files are created on the local drive in the directory Program Files\Vista\Imaging\BackProc\Log. If a remote network location is entered, the Background Processor must have Read and Write access to it. Use the \\computer name\share name format and do not use a letter drive for the remote network location.

4. Click **OK** to save the information and close the window.

9.5.2 Background Processor Purge Configuration

The BP Purge / Verifier / RAID Group Advance Settings window is used for setting up the Scheduled Verifier, Scheduled Purge, and RAID Group Advance activities. In addition, the parameters for the Purge activity are set up through this window.

Selecting the Edit | Purge / Verifier / RG Settings menu in the Queue Processor window opens the BP Purge / Verifier / RAID Group Advance Settings window.

The screenshot shows the 'SALT LAKE CITY UT - BP Purge / Verifier / RAID Group Advance Settings' dialog box. It is organized into several functional areas:

- Purge Section:**
 - Retention Days:** Full Files (333, 9/22/2012), Big Files (2891, 9/21/2005), Abstract Files (333, 9/22/2012), Photo IDs/Ad Direct (9999, 4/6/1986).
 - Purge By:** Radio buttons for Date Accessed, Date Created, and Date Modified (selected).
 - Auto Purge:** Checked checkbox, Last Purge BP Server: BP1, Purge Factor: 1.
 - Express Purge:** Active checkbox (unchecked), Purge Rate field.
 - Scheduled Purge:** Active checkbox (checked), Last Purge Date: 8/21/2013, Frequency (in days): 1, Next Purge Date: 8/22/2013, Purge Time: 0700.
- Last Verify BP Server:** BP1
- Scheduled Verifier:** Active checkbox (checked), Check Text Files checkbox (unchecked), Last Verifier Date: 5/24/2012, Frequency (in days): 1, Next Verifier Date: 5/25/2012, Verifier Time: 2355.
- Scheduled RAID Group Advance:** Active checkbox (unchecked), Last RAID Advance field, Frequency (in days) field, Next Advance Date field, Advance Time field.

At the bottom of the dialog are buttons for OK, Cancel, Apply, and Help.

Purge Settings

The Purge process is used to remove image files from Tier 1 when the free space is low or when older and/or not recently viewed image files can be purged to allow room for newly acquired images. It is important to note that no file is purged from Tier 1 shares if it has not been verified and confirmed as saved on Tier 2.

The Purge can be run manually in standalone mode or as a part of the Queue Processor. The Purge Parameters are used to control the purge activities in auto, manual and scheduled modes.

Guidelines for Setting Retention Days on Files for the Purge

General guidelines:

- Determine the span of dates of images that will be preserved on the **Imaging shares**.
- The shorter the timeframe, the more space will be free on Tier 1 when the purge completes.
- Multiple purges may be required to determine the retention days. It is advisable to start with one share with a large retention days value.
- Not all sites capture all the file types specified in the parameter list (e.g. BIG, Photo ID).
- If the frequency and the results of purging are acceptable, then it is not advisable to change the Purge values.
- If there is still not enough free space after the purge, decrease the Retention Days in Purge Parameters (BIG and FULL files, in particular) and repeat the purge until the desired free space is obtained.

Factors that determine the best set of purge parameters for an individual site are:

- The frequency of purges
- The volume of image acquisition rate
- The volume of image file retrieval
- The use of Pre-Fetch
- The capacity of disk space for VistA Imaging Tier 1 shares

Some sites have extended their Tier 1 capacities and are able to maintain five or more years of images on the shares. These sites may only need to purge once per year to purge off the latest year of images (year 6). Others who have smaller Tier 1 sets have to purge more frequently and can only have a limited amount of images on their shares.

For your site, strive to keep the shares between 80% and 90% full (or between 10% and 20% free space). When the Purge process completes and the resulting free space is in excess of this values, then adjust the parameters accordingly.

Configuring the Retention Days Settings

Retention Days		Retention Dates	
Full Files	333	9/15/2012	
Big Files	2891	9/14/2005	
Abstract Files	99999	10/31/1739	
Photo IDs/Ad Direct	99999	10/31/1739	

Field or Checkbox	Description
Retention Days and Retention Dates box	
Full Files	Source: Images from the DICOM Gateways, Clinical Capture workstations and Imports File extensions: 756,ASC,AVI, BMP,BW,DCM, DOC, HTM, HTML, JPG, MHT, MHTML, MP3, MP4, MPEG, MPG, PAC, PDF, RTF, TGA, TIF, WAV Range: 0 - 99,999 (number of days back from the current date that files should be retained)
Big Files	Source: Images from the DICOM gateway and Clinical Capture workstations. File extensions: BIG Range: 0 - 99,999 (number of days back from the current date that files should be retained)

Field or Checkbox	Description
Abstract Files	Source: Images from the DICOM gateways, Clinical Capture workstations and Imports. Abstract files are derivatives of the TGA/BIG format files. File extensions: ABS Range: 0 - 99,999 (number of days back from the current date that files should be retained)
Photo IDs/Ad Direct	Source: Source: Patient photo images and Advance Directives from the Clinical Capture workstations. File extension: JPG Range: 0 - 99,999 (number of days back from the current date that files should be retained)

1. Enter the number of days that each of the four file types above should remain on the shares based on the purge date criteria in the section *Configuring Purge Date Criteria Settings*.
Note: The FULL and BIG files are typically larger file sizes and consume more free space on the shares than the abstracts and photo IDs and Advance Directives.
2. As a result of different file type sizes, set fewer retention days for the larger file to free more space.
3. Because the abstracts and photo IDs are smaller files, set the retention days for purging these two types of files to a higher value than the values for the FULL/BIG file retention days. Also, the availability of Photo IDs and Advance Directives on Tier 1 has a great impact on patient care.
4. Because the abstract files are viewed as thumbnails on the Clinical Display workstation, set the retention days to retain a minimum of 5 years (1,825 days) on the shares regardless of the capacity of the Tier 1 to make viewing on the Clinical Display workstations more efficient.

Configuring Purge Date Criteria Settings

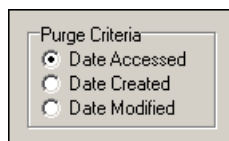

Purge Criteria	
Date Accessed	Date when the file (image) was last viewed on a VI workstation
Date Created	Date when the file was copied to the current disk share
Date Modified	Date when the file was last changed. On the initial save, the Date Created will be the same as the Date Modified.

Any of the three file date/times can be used (date accessed, date modified, date created) to purge the shares. There have been instances where third party utilities have changed the access dates on all the files it “touched” to the same recent date.

When the purge is activated, no files are deleted as none of the file access dates are purge candidates. It is recommended that the Date Modified be used. This date is retained when files are moved across storage media and is a reliable date for purging.

Configuring Scheduled/Express Purge Settings

Field or Checkbox	Description
Auto Purge	Enables the Purge to run when the high water mark is reached on a RAID Group. Important: Auto Purge should always be enabled.
Last Purge BP Server	BP Server on which the last purge was run
Purge Factor	Multiple of the % Server Reserve (found on the Imaging Site Parameters window). When the free space falls below value of the % Server Reserve times the purge factor, a purge is initiated on the next available online RAID Group. The default value of the purge factor is 2.
Express Purge Section	
Active	Enables an Express Purge
Purge Rate	When the number of image entries that have been evaluated for purging (based on the date criterion), without deletion, the purge process for that share will cease. The default Purge Rate value is 100,000.
Scheduled Purge Section	
Active	Enable scheduled purges
Last Purge Date:	Date when the last purge was run
Frequency (in days)	The number of days added to the Last Purge Date to determine the next Scheduled Purge Date. If this field is left blank, the Scheduled Purge can be scheduled for a single event. When the event takes place, the Next Purge Date is cleared.
Next Purge Date	Next scheduled Purge date
Purge Time	Time of day for the next scheduled Purge

Note: Before an automatic purge is set up, a manual purge should be run on a share to make sure the Purge Parameters are set properly.

The automatic purge will use these same Purge Parameters and if not set properly, will result in unsatisfactory results. As the volume of images increases from the gateways, etc, these parameters should be adjusted to compensate for the increase.

Scheduled purges typically are set up on a monthly basis, but this will vary per site. The goal is to keep the shares between 80% and 90% full. Some adjustments in scheduling will need to be made after a scheduled purge cycle has completed.

Enabling Express Purge will greatly enhance the purging process by eliminating unnecessary file traversals that are not candidates for purging and thus significantly decrease the time to purge a share. The Purge Factor is set to control when the purge on a share is terminated. When the number of files that are traversed and not deleted has exceeded the number in the Purge Factor, the purge stops on that share and begins purging the next share (automatic mode).

9.5.3 Network Location Manager: Adding a New Tier 1 or Tier 2 Storage Location and other Storage Types

Note: The following procedure applies to all the tabs in the Network Location Manager window.

1. From the Queue Processor menu bar, select **Edit | Network Location Manager** to open the following window.

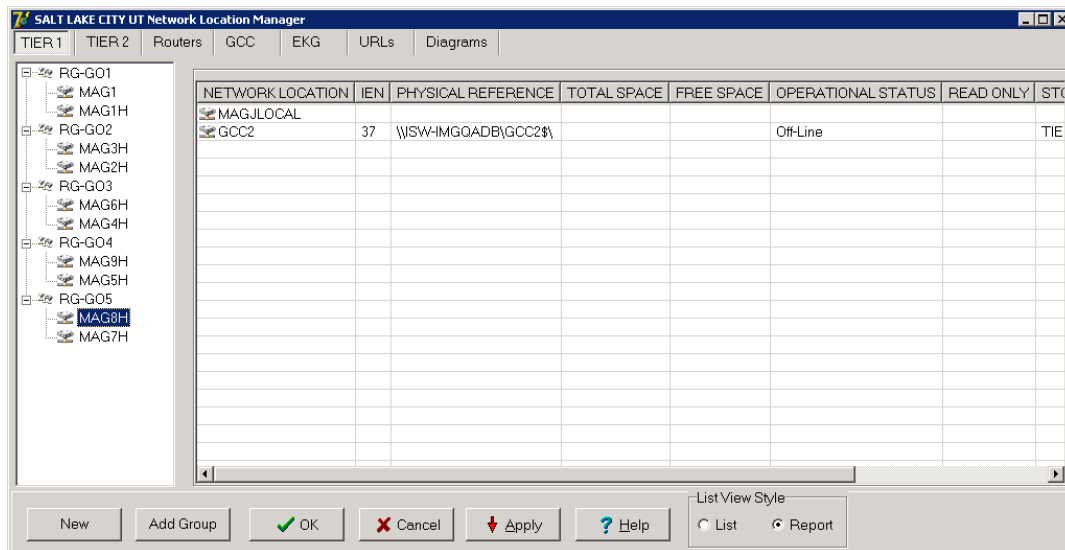

The Tier 1 tab is automatically selected.

2. To add a new network location, click the **New** button at the bottom. The Network Location Properties window will be displayed.

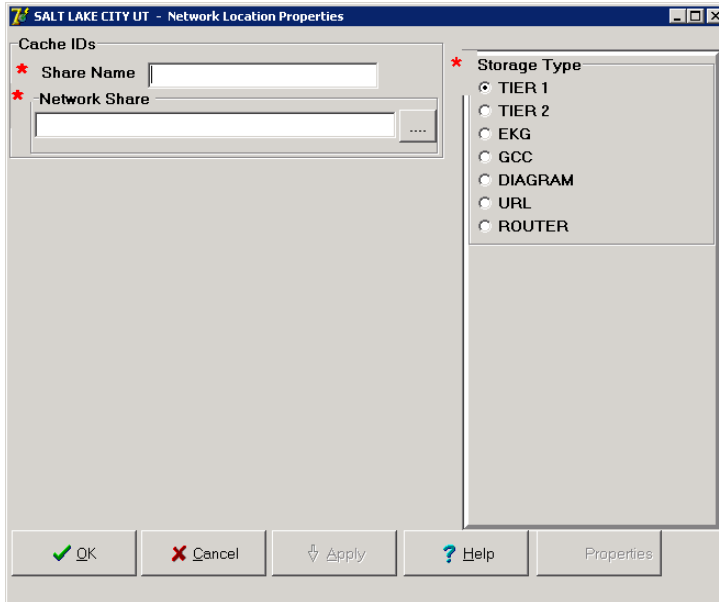

3. Type the Share Name.
4. At the Network Share field, either type the path to the location where images are to be stored, or click the **browse (...)** button and specify the path.
5. Select the appropriate option at the Storage Type field.
6. Click **Apply**.

Additional fields relevant to the storage type are displayed. The example below is for Storage Type RAID only.

Note: The STORAGE TYPE field is preselected depending on the Network Location tab selected. If the EKG tab is selected, then the STORAGE TYPE will be set to EKG, and so forth. However, the preselected value can be modified.

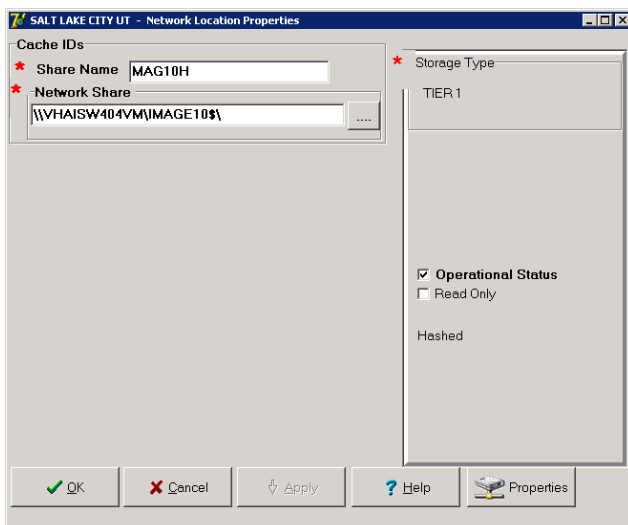

7. Leave the **Operational Status** check box selected by default setting, or clear it.
8. Leave the **Read Only** check box cleared by default setting or select it.
9. Click **Apply** to add the changes to the database or click **OK** to add the changes and exit.

9.5.4 Background Processor Imaging Site Parameters Edit Functions

Imaging Site Parameters Window

The Edit | Imaging Site Parameters menu on the Queue Processor menu bar opens the Imaging Site Parameters window used to modify and save parameters in the VistA database. Each of the boxed areas in the window is described below.

The screenshot shows the 'SALT LAKE CITY UT - Imaging Site Parameters' window. The window title bar includes the text 'SALT LAKE CITY UT - Imaging Site Parameters'. The main content area is organized into several sections:

- Administrative:** Includes fields for 'Current Namespace' (GO), 'Tier 1 Write Location' (MAG1H), 'Generic Carbon Copy', 'Current Tier 1 Group' (RG-G01), 'Import Queue Security' (checked), 'Site Code' (000), and 'Associated Institutions' (SALT LAKE DOM WASHINGTON, DC and ALBANY, NY).
- Clinical Workstation:** Includes a checked 'Use Capture Keys' checkbox, and numeric fields for 'Timeout Windows Display' (122), 'Timeout Windows Capture' (120), 'Timeout VistARad' (600), and 'Default MUSE Site #' (1). A dropdown for 'Default User Preference' is set to 'CAMP,EIGHT (SETTING 1)'.
- Storage Functions:** Includes 'Tier 2 Write Location' (WORMOTG SALT LAKE CITY UT), '% Tier 1 Reserve' (1), '% Tier 2 Reserve' (5), 'Auto Write Location Update' (unchecked), 'Multiple Namespace' (DM, GO), and 'File Types' (TXT).
- Service Accounts:** Includes fields for 'Windows Username' (vhamaster/vhaiswIU), 'Windows Password', 'VistA Access', and 'VistA Verify'.
- DICOM interface:** Includes 'DICOM Gateway Write Location' (MAG1H), 'DICOM Gateway Interface Switch Update' (checked), 'Retention Days HL7 - Modality Worklists' (45), '% Free Space DICOM Messages' (10), and 'Retention Days DICOM Messages' (15).
- Telereader:** Includes 'Net Site Service' (VISTASITESERVICE) and 'Timeout TeleReader' (180).

At the bottom of the window, there are four buttons: 'OK', 'Cancel', 'Apply', and 'Help'.

Administrative Settings

Field or Checkbox	Description
Current Namespace	Each VHA facility has its own unique 3-character designator. The Current Namespace file is used to store this 3 letter facility designator. It is used in Imaging as the first 3 characters of the 14-character name given to image files captured at this site. The VistA Imaging development and support teams maintain a central database with each sites 3 letter designator. The Current Namespace field is not configurable. This is necessary to ensure that image file names across VHA are unique.
Tier 1 Write Location	All images from the gateways, Capture, etc. will be written to this share. The selected Current RAID Group determines which shares are listed on this dropdown list.
Generic Carbon Copy	Remote share where files will be exported. The share permissions must match the login credentials for the BP Server.
Current RAID Group	The current active RAID Group includes the Tier 1 Write Location (described above). When new images are processed, they are stored on the Tier 1 Write Location share within this group. The RAID Groups are set up with the Network Location Manager.
Import Queue Security	Checks users Imaging security keys for permission to capture images
Site Code	Three-letter acronym for the site location. This is used for AutoRouting and MUSE.
Associated Institutions	This set of institution values will allow users from other institutions to access local images. Note: Right-clicking this field displays an Add/Delete popup menu that can also be accessed from the keyboard by using Shift + F10.

Field or Checkbox	Description
VistARad Grouping	<p>The radiologist can lock/interpret exams for other divisions (including the Parent Institution or other Associated Institutions), when those divisions are included in this set of institutions. Note that this setting controls exam locking and updating, as well as filtering of the UNREAD Exams lists to show only the Institutions that are defined here.</p> <p>Note: Right-clicking this field displays an Add/Delete popup menu that can also be accessed from the keyboard by using Shift + F10.</p>

Storage Functions Settings

Field or Checkbox	Description
Tier 2 Write Location	Tier 2 share where newly acquired images are currently being written.
% Tier 1 Reserve	The purpose of the reserve is to provide a significant amount of reserved primary storage to allow time for corrective action to create more space on the shares. Enter an integer between 1 and 50.
% Tier 2 Reserve	The default value is 5%. The values can be set in the range 0-50%. When the allocated space does not meet this watermark, then no JUKEBOX queues will be processed and Tier 2 retrieval requests may be compromised, depending on the Tier 2 technology.
Auto Write Location Update	<p>At the interval of every 20 minutes or 100 images written to a share, the Queue Processor will determine which share within a group has the most space and will use that share as the current write location for newly acquired images.</p> <p>To manually select a Tier 1 Write Location, uncheck the Auto Write Location Update box. Images will be written to the selected Tier 1 share until it is filled or manually changed to another share.</p>

Field or Checkbox	Description
Multiple Namespace	List of all the legacy namespaces that have been used at a site and are reflected in the filenames on the Tier 1 and Tier 2 shares. Note: Right-clicking this field displays an Add/Delete popup menu that can also be accessed from the keyboard by using Shift + F10.
File Types	File extensions outside of the standard extensions that the BP products will recognize and treat as a standard extension file. Note: Right-clicking this field displays an Add/Delete popup menu that can also be accessed from the keyboard by using Shift + F10.

TeleReader

The screenshot shows a dialog box titled 'Telereader'. It contains two settings: 'Net Site Service' is a dropdown menu currently showing 'VISTASITESERVICE', and 'Timeout TeleReader' is a text input field containing the number '180'.

Field or Checkbox	Description
NET SITE SERVICE	The web service used by Remote Image Views to gain access to remote sites
Timeout TeleReader	The number of minutes that the TeleReader application will remain active before closing due to inactivity. If this field is undefined, the application will not timeout. Max value is 999999, no decimals allowed.

Clinical Workstation Settings

The screenshot shows a dialog box titled 'Clinical Workstation'. It contains several settings: 'Use Capture Keys' is a checkbox that is unchecked; 'Timeout Windows Display' is a text input field with '120'; 'Timeout Windows Capture' is a text input field with '120'; 'Timeout VistARad' is an empty text input field; 'Default MUSE Site #' is an empty text input field; and 'Default User Preference' is a dropdown menu showing '{user}' and '(SETTING 1)'.

Field or Checkbox	Description
Use Capture Keys	Check users' Imaging security keys for permission to capture images.
Timeout Windows Display	Number of minutes until the Imaging Display application will close due to inactivity. The default setting is 120 minutes (Range 6 to 600).

Field or Checkbox	Description
Timeout Windows Capture	Number of minutes until the Imaging Capture application will close due to inactivity. The default setting is 120 minutes (Range 6 to 600).
Timeout VistARad	Number of minutes until the Imaging VistARad application will close due to inactivity. There is no default setting.
Default MUSE Site	MUSE site number that the Imaging Display application will connect to. Site numbers are usually 1, 2, 3, If left empty, the field defaults to 1.
Default User Preference	A specified user's parameter settings will be used for first-time users of the Imaging system.

Service Accounts Settings

These credentials are shared between the DICOM Gateway, Image cluster, Jukebox Server, and Background Processor.

Field or Checkbox	Description
Windows Username	Imaging Administrator domain Service Account (IA Account) used to access the Imaging shares on the RAID and archive (jukebox) share. Both the RAID and archive (jukebox) shares must have READ/WRITE permission to this account.
Windows Password	Domain password used to access the Imaging shares on the RAID and archive (jukebox) share.
VistA Access	Encrypted access code for the Imaging Service Account in VistA. This account will be used to automatically re-log into the application when there is a loss of connectivity between the BP product and the Broker (VistA). Note: The Imaging Service Account must have the MAG SYSTEM security key and secondary menu option MAG WINDOWS. The VERIFY CODE never expires. This user must have a single division designation.
VistA Verify	Encrypted verify code for the Imaging Service Account in VistA. This account will be used to automatically re- log into the application when there is a loss of connectivity between the BP product and the Broker (VistA).

DICOM Interface Settings

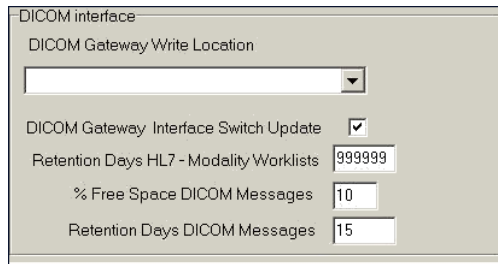

Field or Checkbox	Description
DICOM Gateway Write Location	RAID share where newly acquired images are currently being written.
DICOM Gateway Interface Switch Update	Indicates presence of a DICOM Gateway on the system.
Retention Days HL7 – Modality Work Lists	<p>This field is used as the default value, in days, by the DICOM Text Gateway for three different user menu driven purges:</p> <ul style="list-style-type: none"> • This field is used by the Purge Old Modality Worklist Entries menu option to determine the number of retention days from the date of creation of Modality Worklist Entries. • This field is used by the Purge Old DICOM Message Files menu option to determine the number of retention days from the date of creation of DICOM messages that were sent to commercial PACS. • This field is used by the Purge Old HL7 Transaction Global Nodes menu option to determine the number of retention days from the date of creation of HL7 messages sent from VistA to the DICOM Text Gateway. <p>Note: This value may be overridden by the user when executing any of these menu options.</p>
% Free Space DICOM Messages	Minimum percentage of free disk space for DICOM HL7 messages on the text gateway. A typical value is 25%.
Retention Days DICOM Messages	Number of days to retain DICOM HL7 messages on the text gateway, 30 days is recommended.

9.5.5 Scheduled BP Verifier

The Scheduled Verifier should be set up to run nightly. It will verify the integrity of any image records not validated since the previous Verifier run (Manual or Scheduled). It is suggested that the Verifier be run manually over the entire range of image records before incremental Verifier runs are started. The application that runs for the Scheduled Verifier is the same as the Manual Verifier. Reference the Manual Verifier in the BP User Manual for specific information about the GUI and log files.

9.5.5.1 Guidelines for Setting Parameters for the Scheduled Verifier

The following guidelines for using the Scheduled Verifier will help maintain the integrity of the Imaging records in the VistA database.

Important: If the PC that has Scheduled or Auto events is not a server class, the task will not start.

- Set the Active check box to enable scheduled runs of the BP Verifier. The scheduled runs of the Verifier will only check the most recent VistA records of new images that have been created since the last Scheduled Verifier run.
- Do not select the Check Text Files check box. The contents of the text files on Tier 1 will be compared to the information in VistA. This processing will slow down the Verifier processing and utilities are not available at the present time to correct any issues that surface.
- The Last Verifier Date field is set by the system and cannot be set by the user.
- When the Active parameter is checked, the Frequency (in days) field setting should be 1 so that the Verifier runs daily.
- Initially set the Next Verifier Date to today's date. The scheduling frequency will be based on this date.
- Set the Verifier Time to an inactive period of the day –typically after hours when image creation activity is low.

Description of the Scheduled Verifier Settings

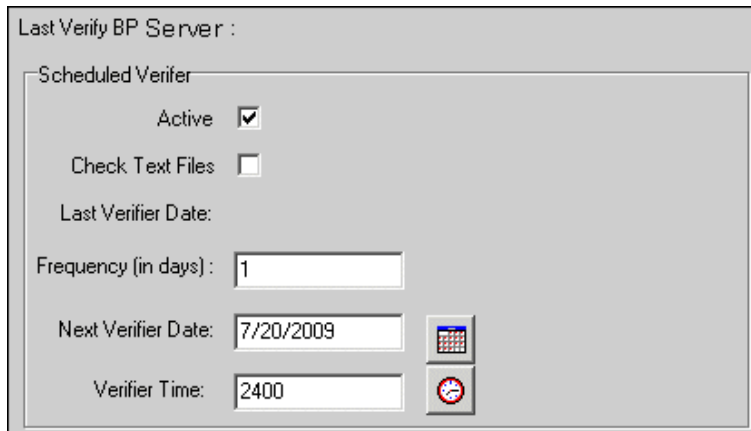

Field or Checkbox	Description
Last Verify BP Server	BP Server on which the Verifier was last run (Display only, set by application)
Scheduled Verifier	
Active	Enables scheduling the Verifier
Check Text Files	Read text files on Tier 1 and determine if: <ol style="list-style-type: none"> 1) the file is binary or unreadable 2) there are unprintable characters in the file 3) The SSN does not match the one in VistA 4) SOP Instance UID mismatch with VistA 5) Study Instance UID mismatch with VistA 6) SOP Instance UID and/or Study Instance UID are blank 7) SSN in the top part of the text file does not match the bottom.
Frequency (in days)	Number of days added to the date of the last time the Verifier application ran to determine the next time the Scheduled Verifier should be run.
Last Verifier Date	Date when the Verifier was last run
Next Verifier Date	Date of the next scheduled Verifier will run based on the Frequency (in days) parameter
Verifier Time	Time of day when the Verifier will run

9.5.5.2 Setting Up the Scheduled Verifier

Use the guidelines above to set up the Scheduled Verifier.

1. Select **Edit | BP Servers**.
2. Drag the SCHEDULED VERIFY task on the BP Server to the location where the Verifier is to be run.
3. Click **OK** to close the window.

4. Select the **Edit | Purge / Verifier /RG Settings** tab.
5. Set the following fields in the Scheduled Verifier box:

Field	Setting
Active	Checked
Check Text Files	Unchecked
Frequency (in days)	1
Next Verifier Date	(starting date)
Verifier Time	(time of day the Verifier will run – after hours is best)

9.5.6 Scheduled RAID Group Advance

The RAID Group Advance is configured on the Imaging Site Parameters window. RAID groups are used to organize Tier 1 shares into logical groups for easy tape backup and restore processing. During the install, all existing online Imaging shares are placed into the first RAID Group, RG-XXX1. This configuration is the same and has been in existence for past years. The Auto Update functionality is also the same. At regular intervals, the current write location will change to the share with the most free space. The Auto-Write function will reset the current write location to provide load balancing within the RAID group. When the % Server Reserve within the group has been reached, the Auto-Write will set the next RAID group as the current write group. In addition, when the used space in that RAID group has reached the high water mark, the next RAID Group that has online shares will become the current RAID group.

9.5.6.1 Guidelines for Setting Parameters for the Scheduled RAID Group Advance

Sites can choose a configuration that suits them best, as follows:

- Use the initial configuration where all the shares are in the same RAID Group. The new images will be evenly distributed among all the shares.
- Nightly incremental tape backups, as well as monthly/quarterly tape backups, must be done on a regular basis on all the shares.
- Distribute the shares among multiple RAID Groups. Fill the shares in each group to the Server Size, and then switch the current write group to the next. New image files will be distributed over all the shares assigned to that group.
- Nightly incremental tape backups, as well as monthly/quarterly tape backups, must be done only on that RAID Group.
- When the RAID group has reached capacity, a final full backup should be done on all of that RAID group's shares. Nightly incremental tape backups and monthly/quarterly tape backups should be started on the next current write group.

Scheduled RAID Group Advance Settings

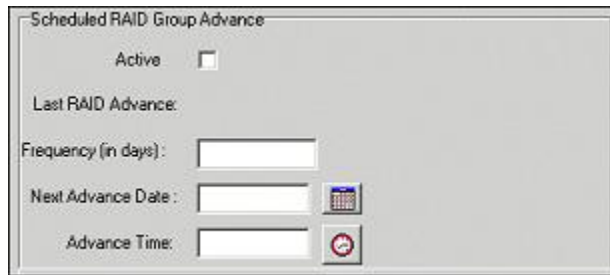

Field or Checkbox	Description
Active	Enable RAID Group Advance scheduling
Last RAID Advance	Date when the last scheduled RAID Group Advance occurred
Frequency (in days)	Number of days added to the date of the last RAID Group Advance to determine the next time the RAID Group Advance will run. If the Frequency parameter is set, the next RAID Group Advance will be scheduled automatically. If the frequency is not set, no automatic scheduling will occur.
Next Advance Date	Date of the next scheduled RAID Group Advance
Advance Time	Required. Time of day of the next scheduled RAID Group Advance

9.5.6.2 Setting Up the Scheduled RAID Group Advance

This option is applicable when there are multiple active RAID Groups. Use the guidelines above to set up the Scheduled RAID Group Advance.

1. Select the **Edit | Purge / Verifier /RG Settings** tab.
2. Set the following fields in the Scheduled RAID Group Advance box:

Field	Setting
Active	Checked
Frequency (in days)	Set by determining how long a span of time images will be written to a set of shares in a Group.
Next Advance Date	Set the starting date when the system will move to the next RAID Group.
Advance Time	Set the starting time of day when the system will move to the next RAID Group.

3. Click **OK** to close the window.
4. Click **Start** on the Queue Processor main window.
(A Queue Processor must be in the running state in order for the RAID Group Advance to run on the designated server.)

9.6 Background Processor Image and File Entry Verifier



As a separate executable, it is necessary to launch the Verifier application from the Programs menu, unless you set up a desktop shortcut. The executable is installed by default in the program files/vista/imaging/backproc subdirectory.

The process examines each non-group entry within the selected range of IMAGE file (#2005) entries. It searches each network magnetic and jukebox share indicated by each IMAGE file (#2005) entry for all extensions of the indicated filename. For each, it does the following:

- When more than one Tier 2 share contains images of the same file name, the Verifier will aggregate those files on a current Tier 2 Write location. It will update the JB references in the IMAGE file (#2005) entry and IMAGE AUDIT file (#2005.1) entry. The Activity column of the Verifier will display this activity as “Aggregate”.
- If any extension of the image file is missing from the referenced Tier 2 share and is both referenced and available on the VistA Imaging Shares, then the Verifier will copy it to Tier 2 and update the appropriate Tier 2 IMAGE file (#2005) references.
- If the VistA Imaging Shares references in the IMAGE file (#2005) entry are not accurate and the appropriate files are available at another network location, then the VistA Imaging Shares references are updated.
- If there is no TGA or ABS file on the network, but a BIG file exists, then the Verifier will create the missing file(s) at the current network write location, aggregate it to the Tier 2, and update the image file jukebox references.

9.7 Imaging Server and Jukebox Backup Information

Sites should establish weekly and daily schedules for backing up images from the VistA Imaging network servers and Tier 2 unit(s). A copy of the backed up media should be kept off site. Full backups and incremental backups are recommended. For further information, refer to the “Backups” section of Appendix B of the *VistA Imaging System Installation Guide*.

9.8 DICOM-related Backup and Purge

As the software in the VistA Imaging DICOM Gateway is being used, information is created and stored. If left alone, this information would accumulate in an unbounded fashion and would eventually exceed any reasonable storage capability.

A number of entities are purged automatically as the software is being used, based on retention parameters that can be set using the software itself.

The storage of images takes a lot of space, and, as a result, images are typically only stored temporarily on the magnetic disks that are connected to the various workstations and servers. For long-term storage, images are typically copied to a jukebox, and then removed from their temporary cache storage.

9.8.1 Growing entities

The VistA Imaging software creates the following entities:

- Image files (pixel data) temporarily stored on VistA magnetic cache servers
- Image Background Queue (^MAGQUEUE (2006.03, i, ...))
- Modality Worklist Entries (^MAGDWLST (2006.56, i, ...))
- DICOM and PACS Messages (^MAGDHL7 (2006.5, i, ...))
- DICOM Failed Images (^MAGD (2006.575, i, ...))
- DICOM Incomplete Images (^MAGD (2006.593, i, ...))
- DICOM Error Log (^MAGD (2006.599, i, ...))
- Error log on DICOM Gateways

9.8.2 Tier 2 Archive

9.8.2.1 File Migration

As a part of normal procedure, captured images are copied to long term storage. The process that copies these files observes the following rules:

- Long-term storage media should be non-rewritable optical media.
- Overwrites are not allowed.
- All image-related files (“Full”, “Big”, and “Abstract”) are copied to Tier 2.
- Site-specified additional file types are copied to Tier 2. (“TXT” is part of the default install setting).
- If a file copy fails, additional attempts are made to copy the file. This is controlled by a site parameter whose default is three attempts.

9.8.2.2 Removing Jukebox Media - Offline Images

The VistA Imaging System is capable of tracking images on platters that have been removed from the jukebox. This is sometimes necessary when all platters in all of slots in the jukebox are full, and a new jukebox has not been purchased or installed. Some sites use this option to archive platters on a first in, first out manner instead of buying additional hardware. By removing a platter, the images on the platter are marked offline. The clinical display software will display an “Archived Image” abstract (thumbnail) for any offline images. If the user clicks on the abstract, a message-box will appear with offline image and associated platter information. If the user chooses to view that image, they can notify an imaging system manager so the platter can be put back into the jukebox. System Managers can also be notified automatically with an email message whenever an offline image is accessed. The OFFLINE IMAGE TRACKERS mail group is installed on the system during the VistA Imaging KIDS installation. System managers that would like to receive notifications should add themselves to the mail group. The procedure below outlines the steps necessary to track offline images.

Note: See the *Storage Utilities User Manual* for the procedure to remove jukebox media.

9.8.2.3 Taking Images Offline

1. Go to DEX Administrator.
2. Click on **View | Reports**, then choose **Media Files**.
3. Click **Next**.
4. Select the media (platter) that will be taken offline. (Multiple select is allowed)
5. Click **Finish**.
6. When the report is available, save it to a file (use Save As) - Be sure to save as type Text (*.txt)
7. Move file to VistA System (ftp; use ASCII mode, not binary mode)
8. Run M option MAG JB OFFLINE (shown below); this procedure will require a FileMan access of “@”.

```

Select Option: MAG JB OFFLINE

Offline Image Menu

  1 Take images offline (Remove Jukebox Platter)
  2 Put images back online (Insert Jukebox Platter)

OPTION: 1

Enter file to read offline images from: J1_0087.TXT

Here goes nothing...

J1_0087A.....
J1_0087B.....

Done.

```

9.8.2.3.1 To Check Which Platters are Offline

```

Select Option: MAG JB OFFLINE

Offline Image Menu

  1 Take DEX images offline (Remove Jukebox Platter)
  2 Put images back online (Insert Jukebox Platter)
  3 Take images offline (Group platters)
  4 List current offline Jukebox Platter
  5 Take 'AA' Archive Appliance images offline (Remove Jukebox Platter)

OPTION: 2

Enter the name of the platter being inserted: ?
Do you want to see a list of all offline platters? y

J1_0085A
J1_0085B
J1_0086A
J1_0086B
J1_0087A
J1_0087B
J1_0143A
J1_0143B
J1_0144A
J1_0144B

```

9.8.2.3.2 To Put Images Back Online

```
Offline Image Menu

 1 Take images offline (Remove Jukebox Platter)
 2 Put images back online (Insert Jukebox Platter)

OPTION: 2

Enter the name of the platter being inserted:
J1_0085A.....
.....Done.
```

9.8.3 Purge Image Files from VistA Magnetic Cache Manually

The Background Processor Purge software purges image files from the VistA Magnetic Cache, depending upon certain criteria set by the site.

To manually operate this software:

1. From the Windows Start | All Programs menu, select **VistA Imaging Programs | Background Processor | Purge**.

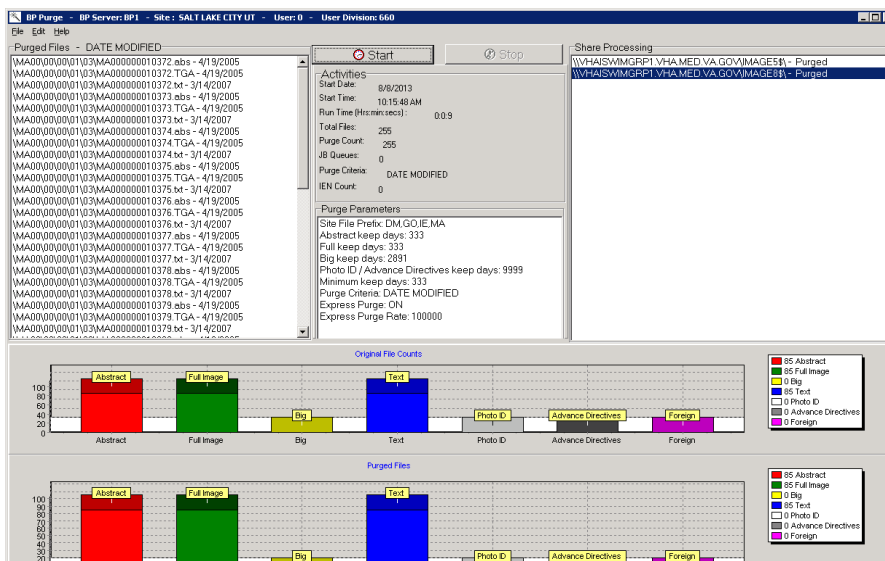

The display box in the upper left quadrant shows the files that will be purged and the date of last access by user application. All listed items are captured in the current Purge.log file. The display is cleared after every 50 items to conserve application memory.

2. To select a subset of image shares for purging, select **Edit | Select Shares**. The Purge Share Select window displays the shares.

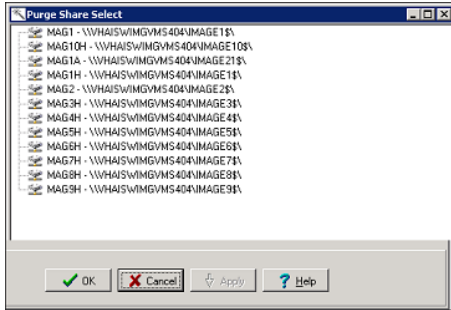

3. Select the share(s) to be purged and click **OK**.
4. Review the Purge parameters and share selection on the Purge window.
5. In the Purge application, click **Start** and **OK** in the confirmation message displayed.

The Activities display (immediately below the start button) shows the time of execution and gives running totals for the VMC files evaluated, the number purged, and the number that were queued to be copied to the Jukebox (JB) because they could not be confirmed on the jukebox.

The Share Processing display lists each online, non-routed, magnetic type share in the NETWORK LOCATION file (#2005.2). These are input values for each step of the purge process and they are appended with a Purged status as they are successfully processed.

The two graphical displays reflect the runtime categorization of image files evaluated and purged as the purge process progresses. Note that the vertical axis units change over the processing period. Also, the units tend to differ between the two graphs.

Steps in the purge process are:

1. The processor initially gets the information from VistA including site parameters governing file aging criteria and online magnetic file server shares.
2. The hierarchical directory structures on each imaging server share are traversed. For each file in each directory, the date of last access is compared against the VistA site file aging criteria for that file type.
3. Files meeting VistA purge criteria are removed from the Imaging magnetic server share, and the IMAGE file (#2005) is updated in the VistA database to indicate the current Tier 2 Write location of the files on the Tier 2.
4. If the image file being evaluated resides on an imaging server share other than the one indicated in the IMAGE file (#2005) in the VistA database, then the file on the unreferenced share is purged regardless of the date of last access as long as the file is present at its referenced location.
5. If there is no corresponding IMAGE file (#2005) entry in the VistA database for this file, the file is purged regardless of age criteria.
6. If the IMAGE file (#2005) in the VistA database is synchronized with the Tier 1, but there is no reference to the file's location on the Tier 2 then a Tier 2 copy is queued and the file is left in place on the Tier 1 share.
7. A site parameter exists for evaluating radiology image files to be held regardless of age if the specific file is related to a radiology package entry with the "NOPURGE" node set.

Note: A monthly verification process may be added to validate the file server references in the IMAGE file (#2005) in the VistA database.

9.8.4 Entities That Are Purged at the Discretion of the Site Supervisor

9.8.4.1 Purge Old Modality Worklist Entries

Old entries may be purged by selecting the option “**Purge old Modality Worklist Entries**” from the “**Text Gateway**” menu.

The subroutine that is called for this menu-option (ENTRY^MAGDDEL1) removes entries in ^MAGDWLST(2006.55, ...) that were time-stamped more than a certain number of days (the default is the number of days specified in ^MAGDICOM(2006.563, 1, "DELETE DAYS")) before the current date.

9.8.4.2 Purge Old DICOM Message Files

Old files and directories may be purged by selecting the option “**Purge old DICOM message files**” from the “**Text Gateway**” menu.

The subroutine that is called for this menu-option (DICOM^MAGDDEL2) removes files and directories that were time-stamped more than a certain number of days (the default is the number of days specified in ^MAGDICOM(2006.563, 1, "DELETE DAYS")) before the current date.

Names of directories that may play a role in this context are stored in ^MAGDICOM(2006.563, 1, "DATA PATH", ...).

9.8.4.3 Purge PACS Messages

Old messages may be purged by selecting the option “**Purge old HL7 transaction global nodes**” from the “**Text Gateway**” menu; these messages are stored in global ^MAGDHL7(2006.5).

The subroutine that is called for this menu-option (HL7^MAGDDEL3) removes entries in ^MAGDHL7(2006.5, ...) that were time-stamped more than the number of days specified in ^MAGDICOM(2006.563, 1, "DELETE DAYS") before the current date.

9.8.4.4 Process DICOM Failed Images

Entries are removed from this file by using the Correct RAD-DICOM File Entries [MAGD FIX DICOM FILE] or the Correct Clinical Specialties DICOM File Entries [MAGD FIX CLINSPEC DICOM FILE] menu options. Using this menu will mark the entries as corrected and will be reprocessed by the VistA DICOM Image Gateway. Entries are stored in global ^MAGD(2006.575).

9.8.4.5 Removal of DICOM Incomplete Images

Entries in this file will automatically be removed after an hour’s time span; entries are temporary stored in global ^MAGD(2006.593).

9.8.4.6 DICOM Error Log

This file should not be purged. It records incomplete files received and images requested to be deleted from the DICOM FAILED IMAGES file (#2006.575). Entries are stored in global ^MAGD(2006.599).

9.8.4.7 MSM Error log

See the *VistA Imaging DICOM Gateway User Manual* for instructions on how to view and purge entries from the MSM Error Log located in global ^UTILITY(“%ER”,+\$H.

9.9 VIX-related Backups

No special backup processes are needed for the VIX (VistA Image Exchange) service.

- Metadata and images stored on the VIX’s dedicated cache are considered transitory copies and are not a part of the patient record. The site from which the data originates is the official custodian of the data, not the VIX.
- The VIX transaction log, which is the primary record of VIX activities, is retained on the server where the VIX is installed for 90 days. A permanent remote backup of the VIX transaction log is also made by the VIX Log Collector service; this is a remote automated service that requires no site configuration or activation.

For more information about the VIX cache and the VIX Log Collector service, refer to the *VIX Administrator’s Guide*.

This page is intentionally blank.

Chapter 10 Callable Routines/Application Programmer Interfaces (APIs)

10.1 Import API

The Import API (Application Programming Interface) was built in VistA Imaging patches 15 and 38 and is used to allow non-imaging VA and commercial vendors to build applications that import images into the VistA database and connect them to the patient record. The Import API was modified in VistA Imaging Patch 108.

The Import API is used by the VA Veteran's ID Card (VIC) and Clinical Procedures applications, as well as commercial applications such as iMed consent and DocManager. The VIC software is used to acquire photographic images of patients. These images are sent to the National Card Management Directory (NCMD). A copy of these photo images are also automatically sent to VistA Imaging through the VistA Imaging Import API.

The Import API also has the following capabilities:

- To check VistA Imaging and verify if a patient has a photo ID on file in VistA Imaging.
- To retrieve a current list of indexing terms.
- To create a new TIU Note stub and attach an image to it.
- To watermark images associated with a Rescinded Advance Directive with the text “Rescinded”.

For more details on the Import API reference the *VistA Imaging System Import API Programmer Guide*. The Import API Programmer Guide can be requested from the VistA Imaging Development Team.

The Import API cannot be used without a written agreement between the VistA Imaging group and the party wishing to use the Import API. All imported images must meet image quality and documentation requirements of VistA Imaging. In addition to the written agreement the VA Policy in section 10.1.1 and FDA Policy in section 10.1.2 must be followed.

10.1.1 VA Policy

VA Policy states the following:

Those components of a national package (routines, data dictionaries, options, protocols, GUI components, etc.) that implement a controlled procedure contain a controlled or strictly defined interface or report data to a database external to the local facility must not be altered except by the VistA Imaging OED staff. A controlled procedure is one that implements requirements that are mandated or governed by law or VA (Department of Veterans Affairs) directive or is subject to governing financial management standards of the Federal Government and VA or that is regulated by oversight groups such as the JCAHO or FDA. A controlled or strictly defined interface is one that adheres to a specific industry standard, will adversely affect a package and/or render the package inoperable if modified or deleted. For national software that is subject to FDA oversight, only the holder of the premarketing clearance (510(k)) is allowed to modify code for the medical device. The holder of a premarketing clearance is restricted to specifically designated VistA Imaging OED staff that are located at the registered manufacturing site and operating in the designated production environment.

Note: Any party interested in interfacing with the VistA Imaging software will need to contact the VistA Imaging development team to get an integration agreement in place.

10.1.2 FDA Policy

FDA Policy states the following:

The Food and Drug Administration (FDA) classifies this software as a medical device. As such, it may not be changed in any way. Modifications to this software may result in an adulterated medical device under 21CFR820, the use of which is considered to be a violation of US Federal Statutes.

10.2 VistA Imaging Import API

10.2.1 Terms of Use

Note: The Import API, as a part of the VistA Imaging software, is regulated as a medical device. The Import API cannot be used without a written agreement between the VistA Imaging HSD&D group and the party wishing to use the Import API.

To secure an agreement for the use of the Import API, the following criteria must be met:

1. Any products built or interfaced using the VistA Imaging Import API must be tested with VistA Imaging. Testing will be performed by the VistA Imaging team with assistance from field sites and the calling package. This testing must demonstrate that there are no adverse interactions affecting the safety, efficacy or performance of the VistA Imaging software or the devices interfaced to VistA Imaging.
2. Any changes to packages/product(s) using the VistA Imaging Import API must be reported to the VistA Imaging Project Office for review and testing before release. Retesting of VistA Imaging with the product(s) is required with any change.
3. Documentation that imported reports/objects meet VHA, regulatory, and quality requirements must be on file with the Vista Imaging Project Office prior to any clinical use. Sample imported reports/objects shall be provided initially to the VistA Imaging Project Office by the package using the API. Sites installing the VistA Imaging API must comply with all VistA Imaging requirements and are responsible for filing all required documentation with the VistA Imaging Project Office, including image quality and data forms and sample reports/objects from any interfaced device.
4. Additional requirements may apply to non-VA software using the Import API.

Chapter 11 Error Recovery, Troubleshooting, and Testing

11.1 Error Recovery

11.1.1 Server or Disk Drive Failure

When a server or disk drive fails, the VistA Imaging System allows immediate action to be taken so that system operation may continue. The following steps should be taken when a server or drive has failed:

- Use the Network Location Manager menu option on the Background Processor and place the share(s) “OFFLINE”. If these are magnetic drives, their images will be automatically pulled from Tier 2.
- If the Image Network Write Location or PACS Image Write Location field in the IMAGING SITE PARAMETERS file (#2006.1) points to a device that is down, edit it to point to a location that is operational. Use the Edit/Site Parameters menu option on the Background Processor.
- When your server or disk drive has been repaired, edit the Operational Status field (#5) of the NETWORK LOCATION file (#2005.2) to “ONLINE”.
- Run the Verifier software on your magnetic shares to synchronize any pointers changed during the failure, and archive unprocessed files to Tier 2.

11.1.2 Delete Image and Pointers

Images can be deleted using the VistA Imaging Display application. When an image is deleted, the image itself and all "derivative" images (such as abstracts) are deleted from the image servers. Additionally, the IMAGE file (#2005) entry for the image, and any pointers to applications (Laboratory, Medicine, etc.) for that image, are deleted as well. To delete images, a user must have the MAG DELETE security key. For Clinical Display users with this key, there will be a Delete in the main menu of the Image List and Radiology Viewer windows. The Delete option will also be available in pop-up menus for images and abstracts.

The following occurs once an image has been flagged for deletion:

1. An entry is made in the Background Queue file and will be processed on a first-in-first-out basis by the Background Processor.
2. The IMAGE AUDIT file (#2005.1) will record the information on the deleted image entry.
3. An entry will be made in the IMAGE ACCESS LOG file (#2006.95) to indicate that an image was deleted.
4. The image entry will be deleted from the IMAGE file (#2005) and any pointed to entries will also be updated.
5. All DOS files relating to the image will be deleted from the Imaging server(s), but not from the jukebox.

ATTENTION: Caution Must Be Taken when Granting the Image Deletion Key.

Note: Anyone who holds the Image Deletion Key is allowed to delete any image, regardless of who created the image in question.

When images are deleted, a reason code must be entered to note why the image was deleted. Sites can optionally add site-specific reason codes by using the MAG REASON EDIT System Manager Menu option, which is explained in Section 8.2 of this document.

11.1.3 Correcting Image Capture Errors

When an image is captured under the wrong patient, it is **strongly recommended** that you use the following procedure to make the needed correction—provided that the images still reside on the Radiology modality, or a hard copy of the image is still available:

1. Correct the patient information on the modality, then resend the image; **or**, if a hard copy (X-Ray film) of the image is available, digitize the image
2. Review the new images acquired
3. Follow the instructions in the section above to delete the incorrect images

If the above approach is not feasible then contact the Imaging Support staff to assist in correcting the images. The steps they will use are covered below.

Two (2) types of errors can be made during image capture:

- An image is captured that the user did not want to save. This type of error is corrected by the image and pointer deletion procedure described above.
- The user identified the patient incorrectly and therefore saved patient B's images with patient A's text record. Presently, this second type of error must be corrected manually by imaging system manager staff using the following procedure.

11.1.3.1 Delete Incorrect Image Pointers from Incorrect Patient's Record

1. Use the edit option of File Manager to access the image field of the parent package (e.g., radiology, cardiology, laboratory, etc.) for the incorrect patient.
2. Identify and write down the names of the images that were incorrectly placed in this file.
3. Delete these entries.

11.1.3.2 Add Correct Image Pointers to Correct Patient's Record

1. Use the edit option to select the correct patient's report file.
2. Edit the image field and enter the exact same image names that were deleted from the incorrect patient.

11.1.3.3 Verify Correction

Ask the user to examine the image of the correct and incorrect patients, and determine whether the correction was done properly.

11.1.3.4 QA Review Utility

In Clinical Display or Clinical Capture, users who have the MAG SYSTEM or MAG EDIT security keys have access to the QA Review Utility. This utility allows users with the appropriate

security key to specify date ranges and perform quality assurance checks on captured images from specified users.

The QA Review Utility also allows the reviewers of the images to change the image indexes by using the Image Index Edit Utility.

11.1.3.5 Image Index Edit Utility

The Image Index Edit Utility is available to users who have the MAG SYSTEM or MAG EDIT security keys. Through this utility, an authorized user can select an image and modify the indexing terms for the image.

11.1.3.6 QA Review Reports

The QA Review Reports are available to users who have the MAG SYSTEM or MAG EDIT security keys. The reports are run for a specified date range and for specific users. The reports give details for users to scan for the date range, status, number of entries and pages, and a percentage representing the total number of images reviewed.

11.2 Troubleshooting / Error Messages

Users may encounter several types of errors as they use the VistA Imaging System. Some of these errors are...

- **Processing errors:** which means that the VistA Imaging System failed to complete a processing task.
- **Data errors:** which means that the VistA Imaging System attempted to use data that was incomplete or formatted incorrectly.
- **Command errors:** which means that users and other programs that interact with Imaging issued commands that conflicted with other commands or with the VistA Imaging System processing state.

A table of error messages, descriptions and causes or solutions is provided in Appendix A of this document and in the *VistA Imaging Error Message Guide*.

11.3 Test Software Available for Troubleshooting

11.3.1 Introduction

When setting up a workstation, it is often necessary to use software to test isolated workstation functions. A number of executables are available for testing:

- Network connectivity
- Connectivity to the Kernel RPC Broker
- Ability to display images
- Connectivity to image servers
- Network timing tests

These executables are described in the following sections.

11.3.2 PING, TRACERT

The PING and TRACERT commands are available in the DOS directory on the workstations. Using these commands can help determine if the IP address supplied in the HOSTS or LMHOST

file is reachable, or if a possible routing problem exists. The local PC support person in IRM can assist with the usage of these commands and the local network IP addressing scheme.

11.3.3 RPCTEST.EXE

The RPCTEST.EXE file is located in the Program Files\VISTA\BROKER directory. This file can be used to test the Broker Client Manager connection to the VistA servers. Once this file is executed, the VistA Access/Verify Code Window should display. If it does not, one or a combination of the following could be happening:

- The TCP Listener is not running on the VistA hospital system.
- An invalid IP address or listening port number was configured during the Broker Client Manager software installation on the workstation.

Note: Please review the Kernel RPC documentation on the usage of this executable file and installation of the RPC Client Manager software.

11.3.4 VistA Imaging Capture, Test Mode

The VistA Imaging Capture software has a Test mode that allows testing of input devices (scanners, video capture boards, etc.). The Test mode features...

- Testing of the capture functions without a connection to the VistA servers.
- No requirement to identify patients.

In addition, the image test file will not be saved. This mode is helpful when interfacing and testing new equipment.

To set the application to test mode, select **Test Mode** from the **Configuration | Configuration Settings | All Settings** menu.

Note: See the Capture online help for additional information.

11.4 Handling Processing and Storage Errors in the New Data Structures

The HDIG and the Archiver handle errors in storing the SOP classes for which support was introduced in MAG*3.0*34. These SOP classes are stored in the data structures that were introduced in MAG*3.0*34.

The section does not apply to processing and storage errors of the SOP classes that were supported before the release of MAG*3.0*34.

11.4.1 How the HDIG and the Archiver Handle Processing and Storage Errors

The HDIG uses the DICOM Gateway notification mechanism to send notifications about processing and storage errors to the email group defined in its configuration. It also sends information about such errors to the modality that sent the DICOM object.

When the HDIG stores an image, it uses two queues defined in the QUEUE file (#2006.927). The Archiver uses the Async Storage Request Queue to archive the objects in long term storage asynchronously. It uses the Async Storage Request Error Queue to record failed storage attempts. Both queues operate through entries made in the QUEUE MESSAGE file (#2006.928).

The Archiver attempts to process storage requests from QUEUE MESSAGE file (#2006.928) entries for the Async Storage Request Queue. If the Archiver is not able to store the object, it waits for 20 minutes before trying again. The Archiver will try to store an object five times. After five unsuccessful attempts to store the object, the Archiver deletes the Async Storage Request Queue entry in the QUEUE MESSAGE file (#2006.928) and creates a corresponding entry for the Async Storage Request Error Queue.

After the error queue message is created, the Archiver cannot make further attempts to store the object until a user examines the failed attempts, resolves the source of the error, and re-enters an Async Storage Request Queue entry in the QUEUE MESSAGE file (#2006.928) for the object.

You can identify and view Async Storage Request Error Queue entries in the QUEUE MESSAGE file (#2006.928) using VistA options on the Hybrid DICOM Gateway Menu [MAGV HDIG MENU] as described in *Using Hybrid DICOM Gateway [MAGV HDIG MENU] Options to Get Information About Asynchronous Storage Error Queue Entries in the QUEUE MESSAGE File (#2006.928)*. After correcting the problem, you can return the archive request back to the Async Storage Request Queue. For information about the procedure, see *Retrying Failed Archive Requests*.

11.4.2 Getting Information About Processing and Storage Errors

There are two ways to get information about processing and storage errors:

- Getting emails from the DICOM Gateway notification mechanism
- Using the Hybrid DICOM Gateway Menu [MAGV HDIG MENU] Options

11.4.2.1 Getting Emails from the DICOM Gateway Notification Mechanism

The HDIG saves processing and storage errors. It sends messages with all processing and storage errors to the email address defined in the configuration of the DICOM Gateway. The HDIG sends an email immediately for processing or storage errors. Image RESENDS and IOD violation errors accumulate during the day and are sent either in groups of 25 or at the end of the day (if fewer than 25).

If you get information about storage and processing errors, you need to identify the cause of the error and correct it. This typically involves identifying the object that caused the error, the cause of the error, and correcting the problem.

11.4.2.2 Using Hybrid DICOM Gateway [MAGV HDIG MENU] Options to Get Information About Asynchronous Storage Error Queue Entries in the QUEUE MESSAGE File (#2006.928)

You can view the information for Async Storage Request Error Queue entries in the QUEUE MESSAGE file (#2006.928) using the Find and List options on the Hybrid DICOM Gateway Menu [MAGV HDIG MENU].

- 1 Log into your VistA account and select the Imaging System Manager Menu [MAG SYS MENU].

```
Select OPTION NAME: MAG SYS MENU      Imaging System Manager Menu

HL7  Imaging HL7 Messaging Maintenance ...
IX   Image Index Conversion Menu ...
[ ... ]
Hybrid DICOM Gateway Menu ...

Select Imaging System Manager Menu Option: Hybrid DICOM Gateway Menu
Find Async Storage Request Errors
List Async Storage Request Errors
Requeue Async Storage Request Errors

Select Hybrid DICOM Gateway Menu Option:
```

- 2 Select Find Async Storage Request Errors [MAGVA ASYNC STORAGE ERR QURY]. This option selects QUEUE MESSAGE file (#2006.928) entries with a QUEUE field value of Async Storage Request Error Queue, and stores them in the MAGV-ASYNC-STORAGE-ERRORS Template.

```
Select Hybrid DICOM Gateway Menu Option: Find Async Storage Request Errors

18 entries selected.

Enter or '^' to exit:
```

- 3 Select List Async Storage Request Errors [MAGVA ASYNC STORAGE ERR LIST].

This option lists detailed information about the QUEUE MESSAGE file (#2006.928) entries selected in the preceding step. The following shows the sample output for the first three of 18 error messages in the Async Storage Request Error Queue.

```
Select Hybrid DICOM Gateway Menu Option: List Async Storage Request Errors

Detail of 18 item(s) selected on Aug 29, 2012@09:06:31:

Number    55 queued on: AUG 24, 2012@14:55
          artifactToken: Z8ewDN1M0000q$XQ0oQ14mja1003ICtEL
          ARTIFACT File entry: 103
          STORAGE TRANSACTION MESSAGE: [null]
          lastError: jcifs.smb.SmbException: The network name cannot be found.

Number    56 queued on: AUG 24, 2012@14:56:01
          artifactToken: Z8ewDN1M0000q$XQ04mh4mja1000iCJEL
          ARTIFACT File entry: 104
          STORAGE TRANSACTION MESSAGE: [null]
          lastError: jcifs.smb.SmbException: The network name cannot be found.

Number    71 queued on: AUG 24, 2012@15:48:12
          artifactToken: Z8ewDN1M00018xbw0jCgomZA1001yc08p
          ARTIFACT File entry: 113
```

```
STORAGE TRANSACTION MESSAGE: Write end dead
lastError: String index out of range: -1
```

The Async Storage Request Error Queue entries in the QUEUE MESSAGE file (#2006.928) provide information about the type of object that is stored and about its token. The listing displays the logged storage error(s) for an artifact resolved using its token. The sequence in the preceding sample was generated following these steps.

- Uses the artifactToken to look up the artifact identifier (IEN of the artifact) from the ARTIFACT file (#2006.916).
- Retrieves the storage transactions for the artifact from the STORAGE TRANSACTION file (#2006.926), filtering for failed transactions. (Those with a STATUS field value of F).
- Displays the MESSAGE field (#7) of the STORAGE TRANSACTION file (#2006.926) entry, which is likely to contain an error.
- Displays the lastError item from the MESSAGE field (#6) in the QUEUE MESSAGE file (#2006.928).

11.4.2.3 Retrying Failed Archive Requests

The Archiver makes five attempts to archive a file before moving it to the Async Storage Request Error Queue. After correcting the cause of the error, a site administrator must manually move the messages from the error queue to the Async Storage Request Queue. This notifies the Archiver to try and store the record again.

This section demonstrates how to move all the messages from the Async Storage Request Error Queue to the Async Storage Request Queue.

From the Hybrid DICOM Gateway Menu, [MAGV HDIG MENU], select Requeue Async Storage Request Errors [MAGVA ASYNC STORAGE ERR REQU].

In this first example, all of the entries are requeued.

```
Select Imaging System Manager Menu Option: Hybrid DICOM Gateway Menu

  Find Async Storage Request Errors
  List Async Storage Request Errors
  Requeue Async Storage Request Errors

Select Hybrid DICOM Gateway Menu Option: Requeue Async Storage Request Errors

Requeuing entry ... Result
  154 ... requeued.
  155 ... requeued.
  156 ... requeued.
  157 ... requeued.
  158 ... requeued.
  159 ... requeued.
  160 ... requeued.
  161 ... requeued.
  162 ... requeued.

  9 Async Storage Request Errors requeued.

Enter or '^' to exit:
```

In this example, the entries have previously been requeued, but the sort template has not been refreshed (with a subsequent **F**ind operation).

```
Select Hybrid DICOM Gateway Menu Option: Requeue Async Storage Request Errors
Requeuing entry ... Result
    154 ... already requeued.
    155 ... already requeued.
    156 ... already requeued.
    157 ... already requeued.
    158 ... already requeued.
    159 ... already requeued.
    160 ... already requeued.
    161 ... already requeued.
    162 ... already requeued.

    0 Async Storage Request Errors requeued.
Enter or '^' to exit:
```

You should run the menu options in this order:

- Find Async Storage Request Errors
- List Async Storage Request Errors
- Requeue Async Storage Request Errors

A List operation displays the current contents of the sort template.

Before running the Requeue option, you must resolve the cause of the storage error.

If the entries have already been requeued when you attempt to requeue them, you should initiate a new Find operation to re-initialize the sort template.

If a situation, such as a server power outage, is the cause of many archive failure errors, it is more efficient to verify a representative sample of the error messages and then requeue the entire set with the Requeue option after the event that has caused the storage failures is corrected.

Chapter 12 External Relations

12.1 HL7 Messages

The Text gateway processes the following HL7 message types to construct and maintain the Modality Worklist Database:

ADT	Admission, Discharge, Transfer
SCH	Patient Appointment and Scheduling Segment
MFN	Master File Notification
ORM	Order Message
ORU	Observational Result – Unsolicited

12.2 HL7 Application Parameters

VistA Imaging includes the following HL7 application parameters:

- **MAG COMRCL PACS**
This application name represents the destination for HL7 messages, and will appear in field 5 of the Message Header segment (MSH-5) of the HL7 message generated by VistA. The value in its FACILITY NAME Field will appear in MSH-6.
- **MAG VISTA IMGNG**
This application name represents the origin for HL7 messages, and will appear in MSH-3. The value in its FACILITY NAME Field will appear in MSH-4.

These entries are added to the HL7 APPLICATION PARAMETER File (#771) during installation.

```
NAME: MAG COMRCL PACS          ACTIVE/INACTIVE: ACTIVE
FACILITY NAME: CPACS FACILITY

NAME: MAG VISTA IMGNG         ACTIVE/INACTIVE: ACTIVE
FACILITY NAME: VA-WOIFO
```

You can change the value of the NAME or FACILITY NAME attributes through VistA option HL EDIT APPL PARAM.

12.3 HL7 Logical Link

VistA Imaging includes the HL7 logical link MAG CPACS .

This entry will be added to the HL7 LOGICAL LINK File (#870) during installation:

```
NODE: MAG CPACS              LLP TYPE: TCP
QUEUE SIZE: 10               READ TIMEOUT: 90
ACK TIMEOUT: 90              TCP/IP SERVICE TYPE: CLIENT (SENDER)
```

This logical link contains information about the commercial PACS destination, including its TCP/IP parameters (IP address and port number). The VistA HL7 package uses the IP address and port number to route messages to their destination over the network. You can change the value of the IP address and port number using VistA option HL EDIT LOGICAL LINKS.

12.4 Imaging Broker Calls

12.4.1 Imaging Broker Calls

All VistA Imaging remote procedure calls are documented in the REMOTE PROCEDURE file (#8994) and can be viewed using FileMan Print File Entries [DIPRINT] or Inquire to File Entries [DIINQUIRY] menu options. VistA Imaging remote procedures use the MAG namespace.

```
FileMan 22

Select OPTION: PRINT FILE ENTRIES
OUTPUT FROM WHAT FILE: REMOTE PROCEDURE
SORT BY: NAME//
START WITH NAME: FIRST// MAG
GO TO NAME: LAST// MAGZ
WITHIN NAME, SORT BY:
FIRST PRINT FIELD:
FIRST PRINT FIELD: [CAPTIONED]
Include COMPUTED fields: (N/Y/R/B): NO// - No record number (IEN), no Computed Fields
Heading (S/C): REMOTE PROCEDURE LIST Replace
START AT PAGE: 1//
DEVICE:
```

12.5 Windows Messaging

In order to communicate with CPRS, windows messages are exchanged on the workstation. The VistA Imaging display clients must be launched from the CPRS menu option to enable the exchange of these messages.

If CCOW is enabled, VistA Imaging Clinical Display and VistA Imaging Clinical Capture will synchronize patient and user context with other CCOW applications (such as CPRS) using CCOW. If CCOW is unavailable, VistA Imaging Clinical Display and VistA Imaging Clinical Capture will continue to synchronize with CPRS when launched from CPRS using Windows messages.

12.6 Integration Agreements

Integration Agreements (IAs) describe how one VistA application uses routines that belong to another VistA application.

To display the ICRs that cover non-Imaging routines used by Imaging, perform the steps below.

1. Sign on to the FORUM system.
2. Select the DBA menu.
3. Select the INTEGRATION CONTROL REGISTRATIONS [IAs] menu.
4. Select the Subscriber Package Menu [SUBS].
5. Choose the “Print ACTIVE by Subscribing Package” option.
6. Enter “IMAGING” at the “START WITH SUBSCRIBING PACKAGE: FIRST//” prompt.
7. Enter “IMAGINGZ” at the “GO TO SUBSCRIBING PACKAGE: LAST//” prompt.
8. Select the device for printing.

To display the IAs that cover Imaging routines used by other applications, perform the steps below.

1. Sign on to the FORUM system.
2. Select the DBA menu.
3. Select the INTEGRATION CONTROL REGISTRATIONS [IAs] menu.
4. Select the Custodial Package Menu [CUST].
5. Choose the “ACTIVE ICRs by Custodial Package” option.
6. Enter “IMAGING” for the package prompt.

12.7 Select the Context Management

This section includes:

- Context Management
- The Clinical Context Object Workgroup Protocol
- The Context Management Settings Tab
- Context Changes
- CPRS Tools Menu for VistARad

12.7.1 Context Management

Context Management (CM) allows users to choose a subject once in one application, and have all applications containing information on that same subject “tune” to the data they contain. This eliminates the need for the user to redundantly select the subject in the varying applications. In the healthcare industry, for example, multiple applications operating “in context” through use of a context manager would allow a user to select a patient (*that is*, the subject) in one application. See the expanded discussion for end users in the *VistARad User Guide*, under **Context Management**.

Context Management is gaining in prominence in healthcare due to the creation of a standardized protocol, the Clinical Context Object Workgroup (CCOW) Protocol, enabling applications to function in a “context-aware” state.

12.7.2 The Clinical Context Object Workgroup Protocol

CCOW is a Health Level 7 (HL7) standard protocol designed to enable dissimilar healthcare software applications to synchronize in real-time, and at the user-interface level. It is vendor independent and allows applications to present information at the desktop and/or portal level in a unified way.

CCOW is the primary standard protocol used in healthcare to facilitate the Context Management process. Although both CCOW and non-CCOW compliant applications can use CM, the CCOW standard helps facilitate a more robust and near “plug-and-play” interoperability across applications.

When CCOW is available, the VistARad client uses CCOW to synchronize patient and user context management with the Computerized Patient Record System (CPRS) and other CCOW-

enabled applications. A new Settings tab, **Context Management**, is used to enable context management; the setting **Enable Context Management** must be checked to use the context management functionality.



The TeleReader application requires CCOW to synchronize patient and user context with other applications such as CPRS and VistA Imaging Display. TeleReader cannot work if CCOW is unavailable. TeleReader will close if CCOW is not functioning properly.

12.7.3 The Context Management Settings Tab

The **Context Management** settings tab allows the user to manage how CM operates on the individual workstation. The user must check the **Enable Context Management** in order to use CM capability.

12.7.4 Context Changes

A context indicator (icon) appears at the top of the various VistARad windows to the left of the **Patient Name** and demographics. A **Context** menu item appears on the **Manager** and **Viewer** menu bars for options to **Suspend/Resume context**, etc. The application also automatically changes the displayed icon to reflect the change in context. See the expanded discussion for end users in the *VistARad User Guide*, under **Context Management**.

Icon	Title	Meaning
	Changing	Displayed when the Clinical Link is changing. This icon may appear so briefly that the user may not see it. It is displayed when the common (linked) patient is changing. For example, if VistARad is linked with CPRS and CPRS changes from one patient to another, this icon will display during the change process.
		Patient Context is Changing
	Broken	Displayed when an application is not linked or the application is “out of patient context.” For example, if CPRS is linked and displaying one patient and VistARad is displaying a different patient, then VistARad is said to be “out of patient context” and will display this icon.
		Patient Context is Broken
	Linked	Displayed when an application is utilizing CCOW to maintain patient context with the CCOW server. For example, if VistARad is open and displaying the same patient (as defined by the CCOW server) for all linked applications, then VistARad will display this icon.
		Patient Context is Joined

12.8 CPRS Tools Menu Option for VistARad

Sites may also configure a new CPRS Tools menu option for launching VistARad from CPRS. Refer to the *Vista Imaging Installation Guide*, under **Associating Display and Capture with CPRS**, for background information on this configuration step. To configure for launching VistARad, add a Sequence, then enter this line of text exactly as shown (no line breaks, no extra spaces):

```
Name=Command:VistARad="Mag_Vistarad.exe" d=%DFN h=%MREF s=%SRV p=%PORT
```

12.9 Mailman Messaging

This section describes the types of MailMan messages that are sent to a site's MAG SERVER mail group.

The MAG SERVER mail group is established when Vista Imaging is installed. MAG SERVER initially contains the addresses of the person that installed Vista Imaging and of the Vista Imaging development team.

- Typical members of this group should be key IRM support staff, radiology managers, and/or ADPACS.
- Text pagers can be added to the MAG SERVER mail group as a "Remote Member", provided that the domain portion of the remote mail member address is defined in the DOMAIN file (#4.2).

Note: The "[G.IMAGING DEVELOPMENT TEAM@FORUM.VA.GOV](mailto:G.IMAGING_DEVELOPMENT_TEAM@FORUM.VA.GOV)" is a required member of this group.

The members of the MAG SERVER mail group (aka the Local Imaging Mail Group) can be edited as described in Chapter 6 of the Background Processor User Manual.

12.9.1 "Image Cache Critically Low" Messages

The Image Cache Critically Low message is generated automatically when the Background Processor is unable to update the network write location within the Vista Magnetic Cache. This happens when the low level mark has been reached and the current location has only 5% (default value) of its capacity available at the time this message is generated.

The following is a sample Image Cache Critically Low Message:

```
Subj: Image Cache Critically Low at OAKMONT.VA.GOV [#118174]
18 Sep 2000 15:22:38 -0600 (CST) 12 lines
From: <IMAGUSER.ONE@SITE1.VA.GOV> In 'CRITICAL' basket. Page 1
-----
SITE: SITE1.VA.GOV
DATE: SEP 18, 2000@15:22:38 CST
SENDER: Imaging Background Processor
The 3 Imaging cache servers will require operator intervention to ensure
continued availability. The following MAG SERVER members are being
notified:
IMAGUSER,TWO
IMAGUSER,THREE
G.IMAGING DEVELOPMENT TEAM@FOR
The next notifications will occur in: 6 hours.
```

This mechanism ensures that the remaining cache locations can be manually referenced during the free space recovery process (BP Purge) that the VistA Imaging System Manager MUST initiate. It is advised that while the purge is running the Auto Write Location update process be turned off, and that the Network Write Location and the PACS Write Location be manually updated to different locations. For more information, see Chapter 6 in the *Background Processor User Manual*.

12.9.2 “Image Site Usage” Messages

When VistA Imaging is installed, a process used to generate monthly Image Site Usage messages is established. Image Site Usage messages contain information about VistA Imaging statistics (images displayed, images captured, etc.) and the software and patch versions installed. The information in these messages is used for the VistA Imaging VISN (Veterans Integrated Service Network) Performance Monitor Report.

Image Site Usage messages are automatically generated at 4:01 AM (VistA System time) on the first day of each month, and will be sent to the MAG SERVER mail group. They can also be generated on demand as described on the next page.

A sample monthly Image Site Usage message is shown below.

```

Subj: Monthly Image Site Usage: DEM0.SITE(Apr 2005) [#19] 01 May 05 04:00 49 lines
From: IMAGUSER,ONE In 'IN' basket. Page 1
-----
SITE: IMGDEM01.MED.VA.GOV
Reporting Period: Apr 01, 2005 - Apr 30, 2005
DATE: MAY 01, 2005@04:00:39 EST
DOMAIN: IMGDEM01.MED.VA.GOV
2005 ENTRIES: 1942
2006.81 ENTRIES: 94
WS DIS VERS: 3.0.0.1^1
WS DIS VERS: 3.0.2.3^4
WS DIS VERS: 3.0.7.10^8
WS DIS VERS: 3.0.7.10^Microsoft Windows 2000 .5.0.2195^1
WS DIS VERS: 3.0.7.7^1
WS DIS VERS: 3.0.8.13^1
WS DIS VERS: 3.0.8.20^1
WS CAP VERS: 3.0.0.1^1
WS CAP VERS: 3.0.7.10^1
WS CAP VERS: 3.0.7.10^Microsoft Windows 2000 .5.0.2195^1
WS VR VERS: 3.0.38^2
WS VR VERS: 3.0.38^Win NT.4.0.1381^1
WS VR VERS: 3.0.40^1
WS VR VERS: UNK^1
VistaRad Version: 3.0T20
DICOM Error Log:0
DICOM FAILED IMAGES:83
Queue File count: 19
Unprocessed Queue entries: 19
28 day Image Workstation Sessions: 3162
28 day Image Workstation Patients: 4658
28 day Image Workstation Images: 14093
28 day Image Workstation Captures: 923
28 day VistaRad WS Display:
28 day VistaRad WS Interpretations:
28 day average daily routed images: 0
BP VERS NUM DATE: <xxx>
Vista Image Version/Build: 3.0^19^3030414
DICOM Gateway Version: 3.0;IMAGING;**1,7,8,3**;30-August-2002^1
Image file namespace(s): DM
From, FileMan Date="3040201", D0="0".
Until, FileMan Date="3040228", D0="7477".
RESOLUTION: SCR_OK^1024^768^24^PC^2

```

```

RESOLUTION: SCR_OK^1024^768^32^PC^9
RESOLUTION: SCR_OK^1152^864^32^PC^3
RESOLUTION: SCR_OK^1280^1024^32^PC^21
RESOLUTION: SCR_OK^1400^1050^32^PC^2
...
...
DICOM CAPTURE: CR^12^Computed Radiography^1
DICOM CAPTURE: CT^500^Computed Tomography
IMPORT API: <xxx>
IMPORT API: <xxx>
CLIN CAPTURE: XRAY^151
OTHER CONSENTS: PRE-ANESTHESIA CONSENT^1
CONSENT FORMS: 0
Image file group parents: 150
Image file objects: 1792
Image file deletes: 12
Document Images (TIF): 123
Document Groups (TIF): 12
Unique Image patients captured: 55
Unique Image patients display: 33
Unique Image patients All: 56
ADVANCE DIRECTIVE SCANNED ADMINISTRATIVE CLOSURE: 0
ADVANCE DIRECTIVE UNSCANNED MANUAL CLOSURE: 25
ADVANCE DIRECTIVE - UMC - ADVANCED DIRECTIVE: 2
ADVANCE DIRECTIVE - UMC - ADVANCE DIRECTIVE FORM: 23
ADVANCE DIRECTIVE SCANNED MANUAL CLOSURE: 8
ADVANCE DIRECTIVE SCANNED MANUAL CLOSURE: 6
ADVANCE DIRECTIVE - SMC - ADVANCE DIRECTIVE: 8
IMAGING PACKAGE INSTALLATION HX: 13^IMAGING^3.0P1^MAY 17,2002^TESTER,ONE
IMAGING PACKAGE INSTALLATION HX: 14^IMAGING^3.0P7^AUG 09,2002^TESTER,ONE
IMAGING PACKAGE INSTALLATION HX: 15^IMAGING^3.0P19^APR 14,2003^TESTER,ONE
IMAGING PACKAGE INSTALLATION HX: 17^MAGJ RADIOLOGY^P3.0T10^JUL 30,2000^TESTER,ONE
IMAGING PACKAGE INSTALLATION HX: 18^MAGJ RADIOLOGY^P3.0T15^JUL 19,2001^TESTER,ONE
IMAGING PACKAGE INSTALLATION HX: 19^MAGJ RADIOLOGY^P3.0T17^JAN 04,2002^TESTER,ONE
IMAGING PACKAGE INSTALLATION HX: 20^MAGJ RADIOLOGY^P3.0T18^JAN 04,2002^TESTER,ONE
IMAGING PACKAGE INSTALLATION HX: 21^MAGJ RADIOLOGY^P3.0T19^FEB 07,2002^TESTER,ONE
IMAGING PACKAGE INSTALLATION HX: 22^MAGJ RADIOLOGY^P3.0T20^FEB 27,2002^TESTER,ONE
IMAGING PACKAGE INSTALLATION HX: 23^MAGJ RADIOLOGY^P3.0T5^AUG 07, 1999^TESTER,ONE
IMAGING PACKAGE INSTALLATION HX: 24^MAGJ RADIOLOGY^P3.0T6^AUG 07, 1999^TESTER,ONE
IMAGING PACKAGE INSTALLATION HX: 25^MAGJ RADIOLOGY^P3.0T9^JUL 30, 2000^TESTER,ONE
LOCAL NETWORK LOCATIONS: 0^NETWORK LOCATION^PHYSICAL REFERENCE^TOTAL SPACE^SPACE
USED^FREE SPACE^OPERATIONAL STATUS^STORAGE TYPE^HASH
LOCAL NETWORK LOCATIONS: 1^LOCAL^C:\IMAGE\^^^On-Line^MAGNETIC^YES
LOCAL NETWORK LOCATIONS: 2^MAG1H^\\imgqadb\image1$\^9080608^^10160^On-Line^MAGNETIC^
LOCAL NETWORK LOCATIONS: 3^MAG1H^\\imgqadb\image1$\^9080608^^1016440^On-
Line^MAGNETIC^YES
ASSOCIATED INSTITUTIONS: 0^Associated Institutions
ASSOCIATED INSTITUTIONS: 1^BANGOR MAINE CBOC
ASSOCIATED INSTITUTIONS: 2^BOSTON HCS VAMC
ASSOCIATED INSTITUTIONS: 3^CALAIS MAINE CBOC
ASSOCIATED INSTITUTIONS: 4^CARIBOU MAINE CBOC
ASSOCIATED INSTITUTIONS: 5^MANCHESTER VAMC
ASSOCIATED INSTITUTIONS: 6^PORTLAND MAINE MH ORC
ASSOCIATED INSTITUTIONS: 7^PROVIDENCE VAMC
ASSOCIATED INSTITUTIONS: 8^RUMFORD MAINE CBOC
ASSOCIATED INSTITUTIONS: 9^SACO MAINE CBOC
ACCESS TYPE (1): 1547
ACCESS TYPE (2): 43
ACCESS TYPE (3): 1577
ACCESS TYPE (4): 64
ACCESS TYPE (6): 1390
ACCESS TYPE (16): 19
ACCESS TYPE (CAP): 32246
ACCESS TYPE (DELETE): 481
ACCESS TYPE (F): 2
ACCESS TYPE (IMGVW): 107716
ACCESS TYPE (INDEX-42): 2
ACCESS TYPE (MEDRPT): 1
ACCESS TYPE (RADRPT): 1847
ACCESS TYPE (RVVAVA): 10026
ACCESS TYPE (TIURPT): 5712

```

The following sections explain how an Ad Hoc (on demand) version of an Image Site Usage message can be generated, describe the contents of a typical Site Usage message, and outline how automatic Image Site Usage message generation can be disabled.

12.9.2.1 Ad Hoc Image Site Usage Messages

To generate an on-demand version of the Imaging Site Usage message, perform the following steps.

1. Access the Imaging System Manager Menu [MAG SYS MENU] and run the Ad Hoc Enterprise Site Report option.

```
Select OPTION NAME: MAG SYS MENU      Imaging System Manager Menu

IX  Image Index Conversion Menu ...
LS  Edit Network Location STATUS                **
Ad hoc Enterprise Site Report
Delete Image Group
Imaging Database Integrity Checker Menu ...    **
Imaging Site Reports

Select OPTION NAME: AD HOC      Ad hoc Enterprise Site Report
```

2. At the next two prompts, enter the date range that you want the report to cover. The prompts will default to the previous month.

```
Enter starting Date: APR 01 2003// <ENTER> (APR 01, 2003)
Enter ending Date: APR 30 2003// <ENTER> (APR 30, 2003)

Creating ad-hoc report over the period 1-Apr-2003 until 30-Apr-2003.

IX  Image Index Conversion Menu ...
LS  Edit Network Location STATUS                **
Ad hoc Enterprise Site Report
Delete Image Group
Imaging Database Integrity Checker Menu ...    **
Imaging Site Reports

Select OPTION NAME:
```

3. After the report is generated, it will be sent in a MailMan message to the MAG SERVER mail group. The subject of the message will be “Ad Hoc Image Site Usage.”

12.9.2.2 Contents of an Image Site Usage Message

The contents of the Image Site Usage message are described in the following table. Note that some entries in the message are dependent on the Imaging components and patches installed—for example, entries specific to VistARad workstations will not be present at sites that do not use VistARad.

Entry Name	Description
Site	The name of the medical center for which the message was generated.
Reporting Period	The time period covered by the report. Note that for Ad-Hoc reports, the date range specified by the user is indicated (which may be greater than the date range of the available data).
Date	The date the message was generated.
Domain	The VistA mail domain name where the message was generated.
2005 Entries	The number of entries in the IMAGE file (#2005), based on the value in the IMAGE File header.
2006.81 Entries	The total number of Clinical Display and Clinical Capture workstations, as indicated in the IMAGING WINDOWS WORKSTATIONS file (#2006.81).
Production Account	The value is equal to "1" if the message is generated from the site's production database environment.
WS DIS VERS	An array showing installations of the VistA Imaging Clinical Display software. The array contains the following values: VERSION ^ OPERATING_SYSTEM ^ #INSTALLED An entry will be generated for each unique combination of VERSION and OPERATING_SYSTEM, for all Display workstations that have been accessed in the last 180 days.
WS CAP VERS	An array showing installations of the VistA Imaging Clinical Capture software. The array contains the following values: VERSION ^ OPERATING_SYSTEM ^ #INSTALLED An entry will be generated for each unique combination of VERSION and OPERATING_SYSTEM, for all Capture workstations that have been accessed in the last 180 days.
WS VR VERS	An array showing installations of the VistARad workstation software. The array contains the following values: VERSION ^ OPERATING_SYSTEM ^ #INSTALLED An entry will be generated for each unique combination of VERSION and OPERATING_SYSTEM, for all VistARad workstation that have been accessed in the last 180 days.
VistARad Version	The most recently installed version of VistARad. For the installation history of all instances of VistARad, refer to the "Imaging Package Installation HX" field.

Entry Name	Description
DICOM Error Log	The total number of unresolved DICOM errors present in the DICOM Error Log (#2006.599) on the date the report was generated.
DICOM Failed Images	The total number of entries in the DICOM FAILED IMAGES file (#2006.575) on the date the report was generated.
Queue File Count	The total number of entries in the IMAGE BACKGROUND QUEUE file (#2006.03), including failed entries that will not be processed without user intervention. (Successfully processed entries are deleted from the file.)
Unprocessed Queue Entries	The total number of unprocessed entries currently in the IMAGE BACKGROUND QUEUE file (#2006.03).
<i>N</i> day Image Workstation Sessions	The number of login sessions that occurred on all workstations (Display, Capture, and VistARad) for the period of the report.
<i>N</i> day Image Workstation Patients	The number of patient lookups performed on Display and Capture workstations for the period of the report.
<i>N</i> day Image Workstation Images	The total number of images accessed from all Clinical Display and Capture workstations for the period of the report.
<i>N</i> day Image Workstation Captures	The number of images acquired using Capture workstations for the period of the report.
<i>N</i> day VistARad WS Display	<p>An array containing information for studies displayed on all VistARad workstations for the period of the report. The array contains the following values:</p> <p>STUDIES ^ IMAGES ^ PATIENTS ^ RAD/NONRAD ^ ROUTED/LOCAL ^ STUDIES_PER_MODALITY</p> <p>STUDIES: The number of studies displayed.</p> <p>IMAGES: The number of images displayed.</p> <p>PATIENTS: The number of patient records accessed.</p> <p>RAD/NONRAD: The number of studies displayed by radiologists and non-radiologists, respectively.</p> <p>ROUTED/LOCAL: The number of routed and non-routed exams displayed, respectively.</p> <p>STUDIES_PER_MODALITY: An array of modalities and the numbers of displayed studies for each modality.</p>

Entry Name	Description
N day VistARad WS Interpretations	<p>An array containing information for studies interpreted using all VistARad workstations for the period of the report. The array contains the following values:</p> <p>STUDIES ^ IMAGES ^ PATIENTS ^ RAD/NONRAD ^ ROUTED/LOCAL ^ STUDIES_PER_MODALITY</p> <p>STUDIES: The number of studies interpreted.</p> <p>IMAGES: The number of images interpreted.</p> <p>PATIENTS: The number of patient records accessed.</p> <p>RAD/NONRAD: The number of studies interpreted by radiologists and non-radiologists, respectively (the value for non-radiologist interpretations should always be 0).</p> <p>ROUTED/LOCAL: The number of routed and non-routed exams interpreted, respectively.</p> <p>STUDIES_PER_MODALITY: An array of modalities and the numbers of interpreted studies for each modality.</p>
N day average daily routed images	The average number of studies routed per day.
BP Vers. Num. Date	<p>An array showing installations of the Background Processor client software. The array contains the following values:</p> <p>CLIENT_VERSION ^ OPERATING_SYSTEM ^ #INSTALLED ^ BUILD_DATE</p> <p>An entry will be generated for each unique combination of VERSION and OPERATING_SYSTEM for all Background Processor workstations.</p>
VistA Image Version/Build	<p>The most recent VistA Imaging KIDS installation, presented in an array with the following values:</p> <p>RELEASE ^ PATCH ^ INSTALL_DATE</p>
DICOM Gateway Version	<p>An array showing installations of the DICOM Gateway workstation software. The array is based on the contents of the DICOM WORKSTATION file (#2006.83), and contains the following values:</p> <p>VERSION;PACKAGE_NAME;PATCHES;BUILD_DATE ^ #_INSTALLED</p>
Image file namespace(s)	The unique 1-, 2-, or 3-character filename prefix used for images stored at this site. If multiple prefixes are used by a site, each prefix will be shown.

Entry Name	Description
From FileMan Date Until FileMan Date	Fields that provide information which may be helpful to support staff when the report contains unexpected values.
Resolution	<p>Reports the number of workstations and the resolutions being used by their monitors.</p> <p>CLASS ^ COLUMNS ^ ROWS ^ BITS ^ TYPE ^ COUNT</p> <p>CLASS: Indicates if the monitors in this group have acceptable or unacceptable display capabilities.</p> <p>COLUMNS^ROWS: The number or vertical and horizontal pixels.</p> <p>BITS: The bit-depth.</p> <p>TYPE : The workstation type (PC or Thin Client (TC)).</p> <p>COUNT: The number of workstations.</p>
DICOM Capture	<p>An array showing the modality and number of images acquired by all DICOM Image Gateways during the reporting period. The array contains the following values.</p> <p>MODALITY_ABBR ^ IMAGES_ACQUIRED ^ MODALITY_NAME ^ GROUPS_ACQUIRED</p> <p>An entry will be generated for each modality that images are acquired from.</p>
Import API	<p>Provides a count of images and image groups that were acquired by the Import API, broken down by sending application (origin).</p> <p>SOURCE_APP ^ #IMAGES ^ #GROUPS</p> <p>Only present for sites that use the Import API.</p>
Clin Capture	<p>An array showing the PROCEDURE Field (#2005,6) and number of images acquired by all Capture workstations during the reporting period. The array contains the following values.</p> <p>PROC_FIELD ^ IMAGES_CAPTURED</p> <p>An entry will be generated for each procedure field entry that images are captured for.</p>
Other Consents	<p>An array showing the number of captured consent forms , based on the contents of the SHORT DESCRIPTION field (#2005,10) for the report period.</p> <p>SHORT_DESC_FIELD^ IMAGES</p> <p>An entry will be generated for each SHORT DESCRIPTION field value containing the word “consent”. (For example, CONSENT and INFORMED CONSENT would be shown in two different entries).</p>
Consent Forms	The number of consent forms captured for the report period.
Image file group parents	The number of image group parent entries added to the IMAGE file (#2005) during the report period.
Image file objects	The number of entries (excluding group parent entries) added to the IMAGE file (#2005) during the report period.

Entry Name	Description
Image file deletes	The number of entries deleted from the IMAGE file (#2005) during the report period. Note that this value indicates only those entries that were both added AND deleted within the report period.
Document Images (TIF)	The number of scanned document images acquired during the reporting period.
Document Groups (TIF)	The number of scanned document groups acquired during the reporting period.
Total Image Objects for Place	The count for entire institutional database
Total Group Parents for Place	The count for entire institutional database
Total Image Entry Deletes for Place	The count for entire institutional database
Unique Image Patients Captured	The number of individual patients that had new images added (using VistA Imaging) during the report period.
Unique Image Patients Display	The number of individual patients that had images displayed using Clinical Display or VistARad during the report period.
Unique Image Patients All	The total number of individual patients that had images displayed or captured during the report period.
Total Non-Verified Images for Place	Count for reporting period
Total Verified Images for Place	Count for reporting period
Total Duplicate Images for Place	Count for reporting period
TLR SPECIALITY	TeleReader reporting period count
TLR PROCEDURE	TeleReader reporting period count
TLR LOCAL STUDIES	TeleReader reporting period count
TLR REMOTE STUDIES	TeleReader reporting period count
TLR LOCAL IMAGES	TeleReader reporting period count
TLR REMOTE IMAGES	TeleReader reporting period count
TLR LOCAL READING TIME	TeleReader reporting period count
TLR REMOTE READING TIME	TeleReader reporting period count
TLR RESULTED LOCALLY BY TELEREADER	TeleReader reporting period count
TLR RESULTED LOCALLY BY CPRS	TeleReader reporting period count

Entry Name	Description
TLR RESULTED REMOTELY BY TELEREADER	TeleReader reporting period count
TLR RESULTED REMOTELY BY CPRS	TeleReader reporting period count
TLR LOCAL ACQUISITION TIME	TeleReader reporting period count
TLR REMOTE ACQUISITION TIME	TeleReader reporting period count
Advance Directive Scanned Administrative Closure	<for future use>
Advance Directive Unscanned Manual Closure	The number of signed Advance Directive notes that do not have attached scanned documents.
Advance Directive – UNC - <i>title</i>	The number of Advance Directive notes without attached scanned documents, broken down by TIU note title.
Advance Directive Scanned Manual Closure	The number of signed Advance Directive notes that have attached scanned documents.
Advance Directive – SMC - <i>title</i>	The number of Advance Directive notes with attached scanned documents, broken down by TIU note title.
Imaging Package Installation HX	<p>An array showing the installation history of the VistA Imaging KIDS software. The array is based on the PACKAGE file (#9.4), and contains the following values:</p> <p>SEQ_NUM ^ PACKAGE ^ VERSION ^ DATE ^ INSTALLER</p> <p>SEQ_NUM: Installation sequence.</p> <p>PACKAGE: The package being installed. “Imaging” is used for the VistA Imaging KIDS packages; “MAGJ Radiology” refers to pre-3.0 Imaging installations of the VistARad software.</p> <p>VERSION: The version number of the software.</p> <p>DATE: The date the software was installed.</p> <p>INSTALLER: The user account used to install the software.</p> <p>Entries will be generated both for current and pre-existing software versions.</p>
Local Network Locations	<p>Each line shows information about a NETWORK LOCATION file (#2005.2) entry defined at the site. The first line (the one that begins with 0) is a header line that show the names of the values reported in subsequent lines. Subsequent lines show 2005.2 entries that:</p> <ul style="list-style-type: none"> • Have a Storage Type other than ‘Export’ or ‘Diagram’ • Are on-line • Are not ‘Routing’ shares.

Entry Name	Description
Associated Institutions	This is the list of institutions whose designated users will use the imaging resources, Images, and shares associated with this this Imaging configuration while logged in to the primary host system. This is a function of the multiple platform design necessary to implement the consolidated Imaging system.
ACCESS TYPE(1)	Clinical care for the patient whose images are being downloaded
ACCESS TYPE(2) ACCESS TYPE(B)	Clinical care for other VA patients
ACCESS TYPE(A)	DICOM transmit to SITE_NAME for reason 1, Clinical care for the patient whose images are being transmitted
ACCESS TYPE(3) ACCESS TYPE(C)	For use in approved research by VA staff
ACCESS TYPE(4)	For approved teaching purposes by VA staff
ACCESS TYPE(D)	DICOM transmit to SITE_NAME for reason 4, Approved teaching purposes by VA staff
ACCESS TYPE(5) ACCESS TYPE(E)	For use in approved VA publications
ACCESS TYPE(6) ACCESS TYPE(R)	Authorized release of medical records or health information
ACCESS TYPE(F)	DICOM transmit to SITE for reason 6: Copy to HIPAA Compliant Storage
ACCESS TYPE(16)	For use in Veterans Benefits Administration claims processing
ACCESS TYPE(17)	Prints from a Display Client.
ACCESS TYPE(18)	Prints from a Display Client.
ACCESS TYPE(AWIVTC)	VistA Web Sessions
ACCESS TYPE(CAP)	Clinical Captures
ACCESS TYPE(DELETE)	Clinical Display Deletes
ACCESS TYPE(EXPORT->..)	GCC queue export events
ACCESS TYPE(IMGVW)	Imaging Displays
ACCESS TYPE(IMGMM)	?? We may need to examine the Windows Session file entry
ACCESS TYPE(INDEX-42)	IMAGE INDEX field sets
ACCESS TYPE(INDEX-ALL)	All INDEX type field sets
ACCESS TYPE(INDEX-45)	Package Index updates

Entry Name	Description
ACCESS TYPE(INDEX-CR)	Procedure/ Event Index updates
ACCESS TYPE(INDXCHG)	Image Index fields updates
ACCESS TYPE(LABRPT)	Lab Reports
ACCESS TYPE(LONGDES)	Parent Record Descriptions
ACCESS TYPE(MAG ANNOT)	Imaging Annotation using CLINICAL_DISPLAY
ACCESS TYPE(MAG UTIL)	Storage Utility Updates
ACCESS TYPE(MEDRPT)	Medicine Reports
ACCESS TYPE(NOIMAGE)	Capture failure/corrupt records
ACCESS TYPE(QFAIL)	Failed Setting JukeBox Queues
ACCESS TYPE(P17CV)	Image Index Commits
ACCESS TYPE(RADRPT)	Radiology reports
ACCESS TYPE(RESCIND)	Rescinded IMPORT Images
ACCESS TYPE(RVDODVA)	VIX / VistA Rad Remote View DOD view of VA images
ACCESS TYPE(RVVADOD)	VIX / VistA Rad Remote View VA view of DOD images
ACCESS TYPE(RVVAVA)	VIX / VistA Rad Remote View VA view of VA image
ACCESS TYPE(SURGRPT)	Surgical Reports
ACCESS TYPE(TIURPT)	TIU Reports
ACCESS TYPE(VR-INT)	VistA Rad Interpretation
ACCESS TYPE(VR-VW)	VistARad Display
ACCESS TYPE(VR-VW/REM)	Remote VistARad Displays

12.9.2.3 MAGREPSTART and MAGREPSTOP

The MAGREPSTART and MAGREPSTOP options can be run to stop and restart the generation of monthly Image Site Usage messages. MAGREPSTART and MAGREPSTOP are not part of any menu, and should be assigned to a system manager or IRM before they need to be executed.

Note: Image Site Usage messages are used to fulfill FDA requirements related to medical device monitoring. MAGREPSTART and MAGREPSTOP should only be run at the direction of the VistA Imaging Group. Use of these options is not necessary under normal conditions.

Note: If the generation of monthly Image Site Usage messages is suspended using MAGREPSTOP, no monthly messages will be generated until the process is restarted using MAGREPSTART.

12.9.3 Watermarking Messages

When a patient’s Advance Directive Note is rescinded, the images that are attached to that note are queued for watermarking with the text “Rescinded”. As part of the watermarking process, the subscribers of the G.MAG SERVER mail group will receive an email with information about the status of the operation when:

- Watermarking is successful
- Watermarking fails

12.9.3.1 “Rescinded” Watermarking Succeeded

Following is an example of the email message generated when the image was watermarked with “Rescinded”:

```

Subj: Import API Report [#31292] 06/22/11@08:14 8 lines
From: PROVIDER, ONE In 'IN' basket. Page 1
-----
0) 1^1 Image(s) Copied OK. 0 Errors.
1) MAGRSND;3110622.081451.3
2) 31
3) RESCINDED IMAGE FILE^\\SERVER1\IMAGE1$\SLA0\00\00\02\05\SLA00000020542.TIF

The preceding array was generated by
the VistA Imaging Import API while
processing a 'RESCIND' Image action.

Enter message action (in IN basket): Ignore//

```

12.9.3.2 “Rescinded” Watermarking Failed

Following is an example of the email message generated if the image could not be watermarked with “Rescinded”.

```

Subj: Import API Report [#31341] 06/23/11@09:52 9 lines
From: PROVIDER, ONE In 'IN' basket. Page 1
-----
0) 0^Image is already Rescinded.

```

- 1) Image(1) 0^<error message for rescind failure>
- 2) Image(1) RESCIND Action is Canceled.
- 3) Image(1) IEN: 20924
- 4) TIU Note: 697

The preceding array was generated by the VistA Imaging Import API while processing a 'RESCIND' Image action.

Enter message action (in IN basket): Ignore//

12.10 Imaging Site Reports

Imaging Site Reports is an ad hoc reporting tool used to evaluate user productivity and details of the variety of images being created by the VistA Imaging application. The audience for these reports will be the managers of the VistA Imaging application.

12.10.1 Document Counts Report

This is a report of the IMAGE file (#2005) of Image Types for an 'Acquisition Site' and a 'From' and 'To' Date/Time Image Saved date range. The report will give totals for each Acquisition Site, Object Type, for each user, within the Acquisition Site and date range. A grand total of images within the Acquisition Site and date range are given at the end of the report.

```
Select Imaging Site Reports Option: Document Count
* Previous selection: ACQUISITION SITE from A to ZZZ
START WITH ACQUISITION SITE: A//
GO TO ACQUISITION SITE: ZZZ//
* Previous selection: DATE/TIME IMAGE SAVED from Jan 1,2000 to Feb 6,2007@24:00
START WITH DATE/TIME IMAGE SAVED: Jan 1,2000// (JAN 01, 2000)
GO TO DATE/TIME IMAGE SAVED: Feb 6,2007// (FEB 06, 2007)
DEVICE: ;999;9999 TELNET
Document Count
Sort Criteria: ACQUISITION SITE from A to ZZZ, DATE/TIME IMAGE SAVED from Jan 1,2000
DATE/TIME IMAGE OBJECT
SAVED TYPE TYPE INDEX IMAGE SAVE BY
-----
ACQUISITION SITE: ACQUISITION 1
MAR 10,2000 08:00 DOCUMENT ADVANCE DIRECTI VISTAIMAGING,FOUR
APR 3,2000 17:31 DOCUMENT ADVANCE DIRECTI VISTAIMAGING,ONE
APR 3,2000 17:36 DOCUMENT FLOWSHEET VISTAIMAGING,ONE
APR 3,2000 17:57 DOCUMENT MEDICAL RECORD VISTAIMAGING,ONE
APR 3,2000 18:01 DOCUMENT MISCELLANEOUS D VISTAIMAGING,ONE
APR 3,2000 18:07 DOCUMENT DIAGRAM VISTAIMAGING,ONE
APR 3,2000 18:07 DOCUMENT DIAGRAM VISTAIMAGING,ONE
APR 3,2000 18:10 DOCUMENT FLOWSHEET VISTAIMAGING,ONE
APR 3,2000 18:14 DOCUMENT MISCELLANEOUS D VISTAIMAGING,ONE
APR 3,2000 18:18 DOCUMENT MISCELLANEOUS D VISTAIMAGING,ONE
APR 3,2000 18:23 DOCUMENT CONSENT VISTAIMAGING,ONE
APR 3,2000 18:28 DOCUMENT MEDICAL RECORD VISTAIMAGING,ONE
AUG 2,2000 10:01 DOCUMENT ADVANCE DIRECTI VISTAIMAGING,ONE
SEP 28,2000 11:41 DOCUMENT CONSULT VISTAIMAGING,TWO
SEP 28,2000 11:50 DOCUMENT CONSULT VISTAIMAGING,TWO
MAY 31,2001 11:42 DOCUMENT MISCELLANEOUS D IMAGING,TEAM
AUG 21,2001 17:54 DOCUMENT ADVANCE DIRECTI VISTAIMAGING,TWO
AUG 21,2001 18:53 DOCUMENT MISCELLANEOUS D VISTAIMAGING,TWO
APR 11,2002 11:10 DOCUMENT VISIT RECORD VISTAIMAGING,THREE
APR 11,2002 11:10 DOCUMENT VISIT RECORD VISTAIMAGING,THREE
AUG 14,2002 19:21 DOCUMENT ALLIED VETERAN TESTER,IMAGING
AUG 14,2002 19:21 DOCUMENT ALLIED VETERAN TESTER,IMAGING
APR 17,2003 17:31 DOCUMENT ADVANCE DIRECTI VISTAIMAGING,TWO
```

```

APR 17,2003 17:40 DOCUMENT CONSENT VISTAIMAGING,TWO
APR 17,2003 17:48 DOCUMENT ADVANCE DIRECTI VISTAIMAGING,TWO
APR 17,2003 17:50 DOCUMENT CONSENT VISTAIMAGING,TWO
MAY 17,2004 19:17 DOCUMENT VISTAIMAGING,ONE
SEP 16,2004 06:42 DOCUMENT VISTAIMAGING,FIVE
NOV 17,2004 09:45 DOCUMENT IMAGE VISTAIMAGING,ONE
NOV 17,2004 09:46 DOCUMENT IMAGE VISTAIMAGING,ONE
NOV 17,2004 09:47 DOCUMENT IMAGE VISTAIMAGING,ONE
NOV 22,2004 09:12 DOCUMENT MEANS TEST (10- VISTAIMAGING,FIVE
NOV 22,2004 09:12 DOCUMENT MEANS TEST (10- VISTAIMAGING,FIVE
NOV 22,2004 12:29 DOCUMENT MEANS TEST (10- VISTAIMAGING,FIVE
NOV 22,2004 12:29 DOCUMENT MEANS TEST (10- VISTAIMAGING,FIVE
-----
SUBCOUNT 35
-----
COUNT 35

```

12.10.2 Image Count by User Report

This is a report of the IMAGE file (#2005) of Image Types for an 'Acquisition Site' and a 'From' and 'To' Date/Time Image Saved date range. The report will give totals for each Acquisition Site, Object Type, for each user, within the Acquisition Site and date range. A grand total of images within the Acquisition Site and date range are given at the end of the report.

```

Select Imaging Site Reports Option: image Type Count by User
* Previous selection: ACQUISITION SITE from A to ZZZ
START WITH ACQUISITION SITE: A//
GO TO ACQUISITION SITE: ZZZ//
* Previous selection: DATE/TIME IMAGE SAVED from Jan 1,2000 to Apr 11,2006@24:
00
START WITH DATE/TIME IMAGE SAVED: Jan 1,2000// (JAN 01, 2000)
GO TO DATE/TIME IMAGE SAVED: Apr 11,2006// (APR 11, 2006)
* Previous selection: IMAGE SAVE BY from A to ZZZZ
START WITH IMAGE SAVE BY: A//
GO TO IMAGE SAVE BY: ZZZZ//
* Previous selection: OBJECT TYPE from A to ZZZZ
START WITH OBJECT TYPE: A//
GO TO OBJECT TYPE: ZZZZ//
DEVICE: ;999;999 TELNET
Image Type Count by User
Sort Criteria: ACQUISITION SITE from A to ZZZ, DATE/TIME IMAGE SAVED from Jan 1,2000 to Apr
11,2006@24:00, I
-----
ACQUISITION SITE: ACQUISITION SITE 1
VISTAIMAGING,ONE
DOCUMENT
SUBCOUNT 8
STILL IMAGE
SUBCOUNT 23
XRAY
SUBCOUNT 17
XRAY GROUP
SUBCOUNT 37
XRAY JPG
SUBCOUNT 2
SUBCOUNT 87

```

Chapter 12 – External Relations

CAMP, ONEHUNDREDDONE	
STILL IMAGE	
SUBCOUNT	1
XRAY GROUP	
SUBCOUNT	1
SUBCOUNT	2
CAMP, SIX	
XRAY GROUP	
SUBCOUNT	1
SUBCOUNT	1
VISTAIMAGING, TWO	
DOCUMENT	
SUBCOUNT	2
XRAY	
SUBCOUNT	2
XRAY GROUP	
SUBCOUNT	2
SUBCOUNT	6
VISTAIMAGING, THREE	
TEXT	
SUBCOUNT	111
XRAY	
SUBCOUNT	2848
XRAY GROUP	
SUBCOUNT	49
SUBCOUNT	3008
VISTAIMAGING, FOUR	
DICOM IMAGE	
SUBCOUNT	3
DOCUMENT	
SUBCOUNT	1
PATIENT PHOTO	
SUBCOUNT	2
XRAY GROUP	
SUBCOUNT	1
SUBCOUNT	7
VISTAIMAGING, FIVE	
ADOBE	
SUBCOUNT	3
DICOM IMAGE	
SUBCOUNT	69
DOCUMENT	
SUBCOUNT	16

MOTION VIDEO	
SUBCOUNT	5
PATIENT PHOTO	
SUBCOUNT	2
STILL IMAGE	
SUBCOUNT	81
XRAY	
SUBCOUNT	1181
XRAY GROUP	
SUBCOUNT	77
SUBCOUNT	1434

IMAGING, TEAM

DOCUMENT	
SUBCOUNT	1
XRAY	
SUBCOUNT	1
XRAY GROUP	
SUBCOUNT	1
SUBCOUNT	3

VISTA IMAGING, SIX

DICOM IMAGE	
SUBCOUNT	2
DOCUMENT	
SUBCOUNT	5
STILL IMAGE	
SUBCOUNT	1
XRAY	
SUBCOUNT	1
SUBCOUNT	9

VISTA IMAGING, SEVEN

COLORSCAN	
SUBCOUNT	5
STILL IMAGE	
SUBCOUNT	50
XRAY GROUP	
SUBCOUNT	17
SUBCOUNT	72

POSTMASTER

XRAY	
SUBCOUNT	1
SUBCOUNT	1

VISTA IMAGING, EIGHT

XRAY	
SUBCOUNT	6
XRAY GROUP	
SUBCOUNT	1
SUBCOUNT	7
TESTER, IMAGING	
DOCUMENT	
SUBCOUNT	2
STILL IMAGE	
SUBCOUNT	4
XRAY	
SUBCOUNT	6
XRAY GROUP	
SUBCOUNT	8
SUBCOUNT	20
SUBCOUNT	4657
COUNT	4657

12.10.3 Means Test Report

This is a report of the IMAGE file (#2005) sorted by 'Acquisition Site', 'From' and 'To' Date/Time Image Saved date range, Export Location = ALL (including null), and Index Type From 'MEANS' to 'MEANSZ'. Report detail will include: Acquisition Site, Patient Name, SSN, Index Type, Date/Time Image Saved, and Export Location.

```
Select Imaging Site Reports Option: MEANS TEST

Right Margin for this report is 132

* Previous selection: ACQUISITION SITE from A to ZZZ
START WITH ACQUISITION SITE: A//
GO TO ACQUISITION SITE: ZZZ//
* Previous selection: DATE/TIME IMAGE SAVED from Jan 1,1960 to Jun 6,2006@24:0
0
START WITH DATE/TIME IMAGE SAVED: Jan 1,1960// (JAN 01, 1960)
GO TO DATE/TIME IMAGE SAVED: Jun 6,2006// (JUN 06, 2006)
DEVICE: ;999;999 TELNET
MEANS TEST
Sort Criteria: ACQUISITION SITE from A to ZZZ, DATE/TIME IMAGE SAVED from Jan 1,1960 to Jun
6,2006@24:00,
PATIENT          SSN  TYPE INDEX
                Date   EXPORT LOCATION
-----
ACQUISITION SITE: ACQUISITION SITE 1
RRRRR,AAAAAAAA  R000 MEANS TEST (10-10EZ)  01/01/1900
RRRRR,AAAAAAAA  R000 MEANS TEST (10-10EZ)
RRRRR,AAAAAAAA  R000 MEANS TEST (10-10EZ)
-----
SUBCOUNT          3
RRRRR,AAAAAAAA  R000 MEANS TEST (10-10EZ)  MAG1-SLC
-----
SUBCOUNT          1
-----
SUBCOUNT          4
-----
COUNT            4
```

12.10.4 Package Index Contains 'Note' Report

This is a report of the IMAGE file (#2005) sorted by 'Acquisition Site, 'From' and 'To' Date/Time Image Saved date range, Short Description, and Package index containing 'NOTE'. Report detail will include: Acquisition Site, Patient Name, SSN, Short Description, Date/Time Image Saved, and Image Saved by. Sub-counts and counts are given per Scanned By, with Short Description, within Patient.

```
Select Imaging Site Reports Option: Package Index Contains 'Note'

Right Margin for this report is 132

* Previous selection: ACQUISITION SITE from A to ZZZ
START WITH ACQUISITION SITE: A//
GO TO ACQUISITION SITE: ZZZ//
* Previous selection: DATE/TIME IMAGE SAVED from Jan 1,1960 to Jun 6,2006@24:0
0
START WITH DATE/TIME IMAGE SAVED: Jan 1,1960// (JAN 01, 1960)
GO TO DATE/TIME IMAGE SAVED: Jun 6,2006// (JUN 06, 2006)
DEVICE: ;999;999 TELNET
Package Index Contains 'Note'
Sort Criteria: ACQUISITION SITE from A to ZZZ, DATE/TIME IMAGE SAVED from Jan 1,1960 to Jun
6,20
PATIENT          SSN  DOC
-----
      ACQUISITION SITE: ACQUISITION SITE 1
VIPATIENT,ONE          V0000 Diagram Neuro Dermatomes
-----
SUBCOUNT              1
VIPATIENT,TWO          V1111 ADVANCE DIRECTIVE
-----
SUBCOUNT              1
VIPATIENT,ONE          V0000 Advance Directive
-----
SUBCOUNT              1
                        MICU Flowsheet
-----
SUBCOUNT              1
                        AFIP Kidney Biopsy Rpt
-----
SUBCOUNT              1
                        Geriatrics Referral
-----
SUBCOUNT              1
                        Diagram
                        OPTHOMOLOGY
                        OPTHOMOLOGY
-----
SUBCOUNT              3
                        Post Anesthesia Flowsheet
-----
SUBCOUNT              1
                        Nursing MICU Admission
-----
SUBCOUNT              1
                        Audiological Evaluation
-----
SUBCOUNT              1
                        Pre-anesthesia Consent
-----
SUBCOUNT              1
                        Manometry Rpt
-----
SUBCOUNT              1
                        Home based health care visit
```

	OPHTHOMOLOGY
	OPHTHOMOLOGY
	OPHTHOMOLOGY
	OPHTHOMOLOGY
	OPHTHOMOLOGY
	OPHTHOMOLOGY
	OPHTHOMOLOGY
	OPHTHOMOLOGY

SUBCOUNT	31
VIPATIENT, SIX	V6666 ADVANCE DIRECTIVE
	ADVANCE DIRECTIVE

SUBCOUNT	2
VIPATIENT, SEVEN	V7777 NURSING NOTE
	NURSING NOTE

SUBCOUNT	2
VIPATIENT, TWO	V1111 CONSULT NURSE MEDICAL WOUND SPEC INPT
	CONSULT NURSE MEDICAL WOUND SPEC INPT

SUBCOUNT	2
	CONSULT NURSE MEDICAL WOUND SPEC INPT

SUBCOUNT	1
VIPATIENT, THREE	V3333 PCC ESTABLISHED INTERMEDIATE
	PCC ESTABLISHED INTERMEDIATE
	PCC ESTABLISHED INTERMEDIATE

SUBCOUNT	3
VIPATIENSIX, PATIENT	S6666 NURSING NOTE

SUBCOUNT	1
VIPATIENT, EIGHT	V8888 DERMATOLOGY NOTE
	DERMATOLOGY NOTE

SUBCOUNT	2
	DERMATOLOGY NOTE

SUBCOUNT	1
VIPATIENT, NINE	V9999 ADVANCE DIRECTIVE

SUBCOUNT	1
	INFORMED CONSENT

SUBCOUNT	1
VIVAPAT, ONE	V0987 ADVANCE DIRECTIVE
	ADVANCE DIRECTIVE

SUBCOUNT	2
	INFORMED CONSENT
	INFORMED CONSENT

SUBCOUNT	2
INTERESTING, CASES	I7312 DERMATOLOGY NOTE
	DERMATOLOGY NOTE

SUBCOUNT	2
	DERMATOLOGY NOTE
	DERMATOLOGY NOTE

SUBCOUNT	2
	ADVANCE DIRECTIVE
	ADVANCE DIRECTIVE

SUBCOUNT	2
	ADVANCE DIRECTIVE

SUBCOUNT	1
VIVAPAT, TWO	V3412 WOUND/OSTOMY NOTE

Chapter 12 – External Relations

SUBCOUNT	1	WOUND/OSTOMY NOTE WOUND/OSTOMY NOTE
SUBCOUNT	2	WOUND/OSTOMY NOTE WOUND/OSTOMY NOTE
SUBCOUNT	2	WOUND/OSTOMY NOTE
SUBCOUNT WOUND, TWO	1	W3027 WOUND/OSTOMY NOTE WOUND/OSTOMY NOTE WOUND/OSTOMY NOTE WOUND/OSTOMY NOTE WOUND/OSTOMY NOTE
SUBCOUNT WOUND, THREE	6	W7321 WOUND/OSTOMY NOTE WOUND/OSTOMY NOTE
SUBCOUNT VIPAT, NINE	2	V1478 Uncompressed TIF
SUBCOUNT VIPATIENT, FOUR	1	V4444 OPHTHALMOLOGIST CONSULT NOTE OPHTHALMOLOGIST CONSULT NOTE
SUBCOUNT	2	OPHTHALMOLOGIST CONSULT NOTE OPHTHALMOLOGIST CONSULT NOTE
SUBCOUNT	2	OPHTHALMOLOGIST CONSULT NOTE OPHTHALMOLOGIST CONSULT NOTE OPHTHALMOLOGIST CONSULT NOTE OPHTHALMOLOGIST CONSULT NOTE
SUBCOUNT	4	OPHTHALMOLOGIST CONSULT NOTE OPHTHALMOLOGIST CONSULT NOTE OPHTHALMOLOGIST CONSULT NOTE
SUBCOUNT	3	OPHTHALMOLOGIST CONSULT NOTE OPHTHALMOLOGIST CONSULT NOTE
SUBCOUNT VIPAT, QWE	2	V2345 Color TIF Test
SUBCOUNT	1	Color TIF Test Uncompressed
SUBCOUNT	1	Color TIF Test 2 Uncompressed
SUBCOUNT	1	Color TIF Test 2 Compressed (jpg)
SUBCOUNT TEST, PATIENT	1	T3333 PCC TELEPHONE NOTE
SUBCOUNT VIPATIENT, FOUR	1	V4444 CARDIOLOGY NOTE CARDIOLOGY NOTE
SUBCOUNT	2	
SUBCOUNT	140	

12.11 VistA Site Service

The VistA Site Service is a central repository of information used by Imaging components (such as Clinical Display) to connect to other sites. Using the site service eliminates the need to store other sites' connection information locally. Local Imaging components access the site service using a special entry in the NETWORK LOCATION file (#2005.2) as described in Chapter 18.

The site service stores the following information for each site:

- Three-digit site number
- Site name
- Region ID (VISN number)
- Station number (field #99 in the INSTITUTION file (#4))
- VistA server hostname
- VistA server port number
- VIX server hostname
- VIX server port number

The last two values in the preceding list only apply at sites that have implemented the VistA Imaging Exchange (VIX) service. See the *VIX Administrator's Guide* for details.

Note: If any of the information above changes, you must contact the VistA Imaging development group to have the site service updated. Incorrect or outdated information will interfere with remote image access.

Sites that have implemented a VIX will also need to update their VIX's configuration after the site service has been updated. This is done by re-running the VIX Installation wizard which will detect the new connection information and reconfigure the VIX accordingly. See the *VIX Installation Guide* for more information.

12.12 VistARad External Relations

VistARad is able, optionally, to interface with the following types of non-VistA Imaging applications.

12.12.1 Voice Dictation Software

VistARad can be configured to interface with voice dictation software on the same diagnostic workstation, or elsewhere on the network. When a voice dictation interface is configured, VistARad sends identifying information for the current exam to the dictation software. Currently, Talk and PowerScribe are supported.

12.12.2 Medical Visualization/3D Reconstruction Software

VistARad can be configured to interface with medical visualization/3D reconstruction software on the same diagnostic workstation. When a medical visualization interface is configured, VistARad can send an exam to the visualization software for various manipulations such as multi-planar reconstruction, 3D reconstruction, and PET/CT Fusion. Currently, Toshiba's Voxar 3D software is supported.

12.12.3 Medical Imaging Resource Center (MIRC) “Teaching File” server

VistARad can be configured to interface with a Medical Imaging Resource Center (MIRC) server. When this interface is configured, VistARad can send an image, an image set, or an entire exam of interest to the server as a “teaching file”. Additionally, VistARad can launch a web browser to the same server, making its teaching file contents available. Only one MIRC server interface can be configured, at any given time, per diagnostic workstation. The MIRC server will not be hosted on the diagnostic workstation.

More information on setting up the interfaces is available from Chapter 3 of the *VistA Imaging Installation Guide*.

Chapter 13 Internal Relations

13.1 Dependencies

13.1.1 Entry/Exit Logic

The VistA Imaging System contains no options that rely on entry or exit logic from other options.

13.1.2 Synchronization

13.1.2.1 Clinical, Diagnostic, and Background Processor Workstations

The VistA Imaging software installed on the VistA Hospital Information System must be synchronized with compatible versions of the software installed on the individual workstations.

13.1.2.2 DICOM Modalities and PACS

The main purpose of the VistA Imaging DICOM Gateway is to act as an interface between external equipment and the VistA Hospital Information System. For each gateway function, in order for that function to be operational, the equipment on both sides of the interface must be up-and-running. In order to test and verify the operational status of equipment, see the *VistA Imaging DICOM Gateway User Manual* for a description of the programs **Ping** and **DICOM_Echo**.

13.1.3 Radiology HL7 v2.1 Protocols

The VistA Imaging DICOM Gateway is dependent on Radiology protocols being active. VistA Imaging must be a subscriber to these protocols. Review the following protocols; the highlighted protocol is the VistA Imaging protocol subscriber. Please review the DICOM Installation manual in the section *VistA - PACS Radiology Interface Setup Instructions* for a step-by-step procedure to setup the protocols.

```
NAME: RA REG          ITEM TEXT: Rad/Nuc Med exam registered
TYPE: event driver    CREATOR: 0
PACKAGE: RADIOLOGY/NUCLEAR MEDICINE
DESCRIPTION: This protocol is triggered whenever a Radiology/Nuclear
Medicine exam is registered. It executes code that creates an HL7 ORM message consisting of
PID, ORC, OBR and OBX segments. The message contains all relevant information about the exam,
including procedure, time of registration, procedure modifiers, patient allergies, and
clinical history.
ITEM: MAGD SEND ORM
ENTRY ACTION: Q          TIMESTAMP: 57877,43203
SENDING APPLICATION: RA-SERVER-IMG MESSAGE TYPE RECEIVED: ORM
EVENT TYPE: O01          PROCESSING ID: PRODUCTION
VERSION ID: 2.1          GENERATE/PROCESS ACK ROUTINE: Q
SUBSCRIBERS: MAGD SEND ORM

NAME: RA RPT
ITEM TEXT: Rad/Nuc Med report released/verified
TYPE: event driver    CREATOR: 0
DESCRIPTION: This protocol is triggered whenever a Radiology/Nuclear
Medicine report enters into a status of Verified or Released/Not Verified. It executes code
that creates an HL7 ORU message consisting of PID, OBR and OBX segments. The message contains
relevant information about the report, including procedure, procedure modifiers, diagnostic
code, interpreting physician, impression text and report text.
ITEM: MAGD SEND ORU
ENTRY ACTION: Q          TIMESTAMP: 57877,43203
SENDING APPLICATION: RA-SERVER-IMG MESSAGE TYPE RECEIVED: ORU
EVENT TYPE: R01          PROCESSING ID: PRODUCTION
VERSION ID: 2.1          GENERATE/PROCESS ACK ROUTINE: Q
```

```

SUBSCRIBERS: MAGD SEND ORU

NAME: RA CANCEL          ITEM TEXT: Rad/Nuc Med exam cancellation
TYPE: event driver      CREATOR: 0
PACKAGE: RADIOLOGY/NUCLEAR MEDICINE
DESCRIPTION: This protocol is triggered whenever a Radiology/Nuclear
Medicine exam is cancelled. It executes code that creates an HL7 ORM message consisting of
PID, ORC, OBR and OBX segments. The message contains all relevant information about the exam,
including procedure, time of cancellation, procedure modifiers, patient allergies and clinical
history.
ITEM: MAGD SEND ORM
ENTRY ACTION: Q          TIMESTAMP: 57877,43203
SENDING APPLICATION: RA-SERVER-IMG MESSAGE TYPE RECEIVED: ORM
EVENT TYPE: 001          PROCESSING ID: PRODUCTION
VERSION ID: 2.1          GENERATE/PROCESS ACK ROUTINE: Q
SUBSCRIBERS: MAGD SEND ORM

NAME: RA EXAMINED       ITEM TEXT: Rad/Nuc Med examined case
TYPE: event driver      CREATOR: 0
PACKAGE: RADIOLOGY/NUCLEAR MEDICINE
DESCRIPTION: This protocol is triggered whenever a Radiology/Nuclear
Medicine exam has reached a status where GENERATE EXAMINED HL7 MSG is Y at that (or at a
lower) status. This message contains all relevant information about the exam, including
procedure, time of registration, procedure modifiers, patient allergies, and clinical history.
ITEM: MAGD SEND ORM
ENTRY ACTION: Q          TIMESTAMP: 57877,43203
SENDING APPLICATION: RA-SERVER-IMG MESSAGE TYPE RECEIVED: ORM
EVENT TYPE: 001          PROCESSING ID: PRODUCTION
VERSION ID: 2.1          GENERATE/PROCESS ACK ROUTINE: Q
SUBSCRIBERS: MAGD SEND ORM

```

13.1.4 Radiology HL7 v2.4 Protocols

Currently HL7 Version 2.4 is the version of HL7 sanctioned for use in the VA enterprise and the version against which commercial PACS have been tested for conformance. Therefore, the v2.4 protocols will ordinarily be subscribed to by VistA Imaging in preference to the v2.1 protocols described in the previous section.

```

NAME: RA REG 2.4
ITEM TEXT: Rad/Nuc Med exam registered (v2.4 HL7)
TYPE: event driver      CREATOR: HENDERSON,MIKE
PACKAGE: RADIOLOGY/NUCLEAR MEDICINE
DESCRIPTION: This protocol is triggered whenever a Radiology/Nuclear
Medicine exam is registered. It executes code that creates an HL7 ORM message
consisting of PID, PV1, ORC, OBR, OBX and ZDS segments. The message contains
all relevant information about the exam, including procedure, time of
registration, procedure modifiers, CPT modifiers, patient allergies, and
clinical history.

This protocol is used to trigger v2.4 compliant HL7 messages.
TIMESTAMP: 61817,46605   SENDING APPLICATION: RA-CLIENT-IMG
TRANSACTION MESSAGE TYPE: ORM   EVENT TYPE: 001
VERSION ID: 2.4
RESPONSE PROCESSING ROUTINE: D MAIN^RAHLACK
SUBSCRIBERS: MAGJ PREFETCH/SEND ORM
SUBSCRIBERS: MAGD SEND ORM

NAME: RA RPT 2.4
ITEM TEXT: Rad/Nuc Med report released/verified (v2.4 HL7)
TYPE: event driver      CREATOR: HENDERSON,MIKE
PACKAGE: RADIOLOGY/NUCLEAR MEDICINE
DESCRIPTION: This protocol is triggered whenever a Radiology/Nuclear
Medicine report enters into a status of Verified or Released/Not Verified. It
executes code that creates an HL7 ORU message consisting of PID, OBR and OBX

```

segments. The message contains relevant information about the report, including procedure, procedure modifiers, diagnostic code, interpreting physician, impression text and report text.

This protocol is used to trigger v2.4 compliant HL7 messages.
 TIMESTAMP: 61817,46605 SENDING APPLICATION: **RA-CLIENT-IMG**
 TRANSACTION MESSAGE TYPE: ORU EVENT TYPE: R01
 VERSION ID: 2.4
 RESPONSE PROCESSING ROUTINE: D MAIN^RAHLACK
 SUBSCRIBERS: **MAGD SEND ORU**

NAME: RA CANCEL 2.4
 ITEM TEXT: Rad/Nuc Med exam cancellation (v2.4 HL7)
 TYPE: event driver CREATOR: HENDERSON,MIKE
 PACKAGE: RADIOLOGY/NUCLEAR MEDICINE
 DESCRIPTION: This protocol is triggered whenever a Radiology/Nuclear Medicine exam is cancelled. It executes code that creates an HL7 ORM message consisting of PID, PV1, ORC, OBR, OBX and ZDS segments. The message contains all relevant information about the exam, including procedure, time of cancellation, procedure modifiers, CPT modifiers, patient allergies and

Enter RETURN to continue or '^' to exit:
 clinical history.

This protocol is used to trigger v2.4 compliant HL7 messages.
 TIMESTAMP: 61817,46605 SENDING APPLICATION: **RA-CLIENT-IMG**
 TRANSACTION MESSAGE TYPE: ORM EVENT TYPE: 001
 VERSION ID: 2.4
 RESPONSE PROCESSING ROUTINE: D MAIN^RAHLACK
 SUBSCRIBERS: **MAGD SEND ORM**

NAME: RA EXAMINED 2.4
 ITEM TEXT: Rad/Nuc Med examined case (v2.4 HL7)
 TYPE: event driver CREATOR: HENDERSON,MIKE
 PACKAGE: RADIOLOGY/NUCLEAR MEDICINE
 DESCRIPTION: This protocol is triggered whenever a Radiology/Nuclear Medicine exam has been edited by the user. It executes code that creates an HL7 ORM message consisting of PID, PV1, ORC, OBR, OBX and ZDS segments. This message contains all relevant information about the exam, including procedure, time of registration, procedure modifiers, CPT modifiers, patient allergies, and clinical history.

This protocol is used to trigger v2.4 compliant HL7 messages.
 TIMESTAMP: 61817,46605 SENDING APPLICATION: **RA-CLIENT-IMG**
 TRANSACTION MESSAGE TYPE: ORM EVENT TYPE: 001
 VERSION ID: 2.4
 RESPONSE PROCESSING ROUTINE: D MAIN^RAHLACK
 SUBSCRIBERS: **MAGD SEND ORM**

13.1.5 Vista Imaging ADT Protocols

Beginning with the release of Patch MAG*3.0*49, Vista Imaging uses HL7 messages to communicate ADT (admission / discharge / transfer) events directly to commercial PACS. ADT information had formerly been sent from the Vista DICOM Gateway using customized DICOM protocols, which have since been deprecated.

Vista Imaging generates and sends these messages through the Vista HL7 package using the following protocols.

NAME: **MAG CPACS A01** TYPE: event driver
 CREATOR: HENDERSON,MIKE
 DESCRIPTION: This protocol generates headers for IHE-based inpatient admission messages to be delivered to a commercial PACS system by Vista Imaging.

Chapter 13 – Internal Relations

```
SENDING APPLICATION: MAG VISTA IMGNG TRANSACTION MESSAGE TYPE: ADT
EVENT TYPE: A01                VERSION ID: 2.4
SUBSCRIBERS: MAG CPACS A01 SUBS

NAME: MAG CPACS A01 SUBS          TYPE: subscriber
CREATOR: HENDERSON,MIKE
DESCRIPTION: This protocol routes inpatient admission messages to a
commercial PACS system.
RECEIVING APPLICATION: MAG COMRCL PACS
EVENT TYPE: A01                LOGICAL LINK: MAG CPACS
RESPONSE MESSAGE TYPE: ACK

NAME: MAG CPACS A02              TYPE: event driver
CREATOR: HENDERSON,MIKE
DESCRIPTION: This protocol generates the header for patient transfer
messages to be delivered to a commercial PACS system by Vista Imaging.
SENDING APPLICATION: MAG VISTA IMGNG TRANSACTION MESSAGE TYPE: ADT

Enter RETURN to continue or '^' to exit:
EVENT TYPE: A02                MESSAGE STRUCTURE: ADT_A02
PROCESSING ID:                 VERSION ID: 2.4
SUBSCRIBERS: MAG CPACS A02 SUBS

NAME: MAG CPACS A02 SUBS          TYPE: subscriber
CREATOR: HENDERSON,MIKE
DESCRIPTION: This protocol routes patient transfer messages to a commercial
PACS system.
RECEIVING APPLICATION: MAG COMRCL PACS
EVENT TYPE: A02                LOGICAL LINK: MAG CPACS
RESPONSE MESSAGE TYPE: ACK

NAME: MAG CPACS A03              TYPE: event driver
CREATOR: HENDERSON,MIKE
DESCRIPTION: This protocol generates headers for IHE-based patient
discharge/end visit messages to be delivered to a commercial PACS system by
Vista Imaging.
SENDING APPLICATION: MAG VISTA IMGNG TRANSACTION MESSAGE TYPE: ADT
EVENT TYPE: A03                MESSAGE STRUCTURE: ADT_A03
VERSION ID: 2.4
SUBSCRIBERS: MAG CPACS A03 SUBS

Enter RETURN to continue or '^' to exit:

NAME: MAG CPACS A03 SUBS          TYPE: subscriber
CREATOR: HENDERSON,MIKE
DESCRIPTION: This protocol routes inpatient patient discharge/end visit
messages to a commercial PACS system.
RECEIVING APPLICATION: MAG COMRCL PACS
EVENT TYPE: A03                LOGICAL LINK: MAG CPACS
RESPONSE MESSAGE TYPE: ACK

NAME: MAG CPACS A11              TYPE: event driver
CREATOR: HENDERSON,MIKE
DESCRIPTION: This protocol initializes the A11 message to be sent from Vista
Imaging to commercial PACS.
SENDING APPLICATION: MAG VISTA IMGNG TRANSACTION MESSAGE TYPE: ADT
EVENT TYPE: A11                VERSION ID: 2.4
SUBSCRIBERS: MAG CPACS A11 SUBS

NAME: MAG CPACS A11 SUBS          TYPE: subscriber
CREATOR: HENDERSON,MIKE
DESCRIPTION: This protocol routes admission cancellation messages to a

Enter RETURN to continue or '^' to exit:
commercial PACS system.
RECEIVING APPLICATION: MAG COMRCL PACS
EVENT TYPE: A11                LOGICAL LINK: MAG CPACS
RESPONSE MESSAGE TYPE: ACK     SENDING FACILITY REQUIRED?: YES
RECEIVING FACILITY REQUIRED?: YES

NAME: MAG CPACS A12              TYPE: event driver
```

```

CREATOR: HENDERSON,MIKE
DESCRIPTION: This protocol generates headers for IHE-based transfer
cancellation messages to be delivered to a commercial PACS system by VistA
Imaging.
SENDING APPLICATION: MAG VISTA IMGNG TRANSACTION MESSAGE TYPE: ADT
EVENT TYPE: A12          VERSION ID: 2.4
SUBSCRIBERS: MAG CPACS A12 SUBS

```

```

NAME: MAG CPACS A12 SUBS          TYPE: subscriber
CREATOR: HENDERSON,MIKE
DESCRIPTION: This protocol routes transfer cancellation messages to a
commercial PACS system.
RECEIVING APPLICATION: MAG COMRCL PACS
EVENT TYPE: A12          LOGICAL LINK: MAG CPACS
RESPONSE MESSAGE TYPE: ACK

```

Enter RETURN to continue or '^' to exit:

```

NAME: MAG CPACS A13          TYPE: event driver
CREATOR: HENDERSON,MIKE
DESCRIPTION: This protocol generates headers for IHE-based inpatient
discharge cancellation messages to be delivered to a commercial PACS system by
VistA Imaging.
SENDING APPLICATION: MAG VISTA IMGNG TRANSACTION MESSAGE TYPE: ADT
EVENT TYPE: A13          VERSION ID: 2.4
SUBSCRIBERS: MAG CPACS A13 SUBS

```

```

NAME: MAG CPACS A13 SUBS          TYPE: subscriber
CREATOR: HENDERSON,MIKE
DESCRIPTION: This protocol routes inpatient discharge cancellation messages
to a commercial PACS system.
RECEIVING APPLICATION: MAG COMRCL PACS
EVENT TYPE: A13          LOGICAL LINK: MAG CPACS
RESPONSE MESSAGE TYPE: ACK

```

13.1.6 Radiology Protocols (VistARad)

VistA Imaging VistARad can be set to automatically prefetch archived images for prior radiology exams. Prefetch is activated by subscribing to the RA REG protocol—the VistARad client protocol is **MAGJ PREFETCH SEND/ORM**. Review the example RA REG protocol below; the bolded protocol is the VistARad protocol subscriber. The Installation Guide has a step-by-step procedure to set up the protocol.

```

NAME: RA REG          ITEM TEXT: Rad/Nuc Med exam registered
TYPE: event driver          CREATOR: IMAGUSER,ONE
PACKAGE: RADIOLOGY/NUCLEAR MEDICINE
DESCRIPTION: This protocol is triggered whenever a Radiology/Nuclear
Medicine exam is registered. It executes code that creates an HL7 ORM message
consisting of PID, ORC, OBR and OBX segments. The message contains all
relevant information about the exam, including procedure, time of
registration, procedure modifiers, patient allergies, and clinical history.
ITEM: MAGD SEND ORM
ENTRY ACTION: Q          TIMESTAMP: 58864,51844
SENDING APPLICATION: RA-SERVER-IMG TRANSACTION MESSAGE TYPE: ORM
EVENT TYPE: O01          VERSION ID: 2.1
RESPONSE PROCESSING ROUTINE: Q
SUBSCRIBERS: MAGD SEND ORM
SUBSCRIBERS: MAGJ PREFETCH/SEND ORM

```

13.1.7 Patient Movement Protocol (DICOM)

The VistA Imaging DICOM gateway is dependent on the Patient Movement (DGPM MOVEMENT EVENTS) protocol being active. VistA Imaging must be a subscriber to this event

protocol. The following is an example of this event protocol; the highlighted protocol is the Imaging protocol subscriber. ATTENTION: This is only pertinent if a VistA Imaging DICOM gateway configuration has been defined. Please review the DICOM Installation manual under section *VistA - PACS Radiology Interface Setup Instructions* for a step-by-step procedure to setup the protocols.

```

NAME: DGPM MOVEMENT EVENTS          ITEM TEXT: MOVEMENT EVENTS v 5.0
TYPE: extended action                CREATOR:
PACKAGE: REGISTRATION
DESCRIPTION:
At the completion of a patient movement the following events take place through this option:

1. The PTF record is updated when a patient is admitted, discharged or transferred.

2. The appointment status for a patient is updated to 'inpatient' for admissions and
'outpatient' for discharges. Admissions to the domiciliary have an 'outpatient' appointment
status.

When a patient is admitted, dietetics creates a dietetic patient file entry and creates an
admission diet order. When a patient is discharged, all active diet orders are

discontinued. If a patient is absent or on pass, the diet orders are suspended.
Inpatient Pharmacy cancels all active orders when a patient is admitted, discharged or on
unauthorized absence. A patient can not be given Unit Dose meds unless s/he is admitted to a
ward. The patient can receive IV meds; however.

When a patient is transferred, an inpatient system parameter is used to determine whether or
not the orders should be cancelled. When a patient goes on authorized absence, the inpatient
system parameter is used to determine whether the orders should be cancelled, placed on hold
or no action taken.

When a patient returns from authorized absence any orders placed on hold will no longer be on
hold.

5. With ORDER ENTRY/RESULTS REPORTING v2.2, MAS OE/RR NOTIFICATIONS may be displayed to
USERS defined in an OE/RR LIST for the patient. These notifications are displayed for
admissions and death discharges.

FILE LINK: GMRD MAIN MENU MIS MANAGER
ITEM: DG MEANS TEST DOM              SEQUENCE: 8
ITEM: DGJ INCOMPLETE EVENT          SEQUENCE: 6
ITEM: DGOERR NOTE                    SEQUENCE: 7
ITEM: DGPM TREATING SPECIALTY EVENT SEQUENCE: 1
ITEM: SD APPT STATUS                 SEQUENCE: 2
ITEM: ORU AUTOLIST
ITEM: ORU PATIENT MOVMT
ITEM: FHWMAS
ITEM: GMRADGPM MARK CHART
ITEM: IB CATEGORY C BILLING          SEQUENCE: 10
ITEM: VSIT PATIENT STATUS
ITEM: SC PCMM INPATIENT ACTIVITY
ITEM: SC ASSIGN PC TEAM ON DISCHARGE
ITEM: YS PATIENT MOVEMENT
ITEM: VAFH HL7 INPATIENT CAPTURE     SEQUENCE: 3
ITEM: VAFH HL7 INPATIENT CAPTURE     SEQUENCE: 4
ITEM: MAGD DHCP-PACS ADT EVENTS
ITEM: IVM FINANCIAL QUERY FOR ADMISSION
TIMESTAMP: 57986,52890
    
```

13.2 VistARad Internal Relations

VistARad interfaces with the following components of VistA Imaging.

13.2.1 VistA Site Service

VistARad will query the VistA Site Service if VistARad is configured to detect a local VistA Imaging Exchange (VIX) server. It may do this even if there is no local VIX available.

13.2.2 VistA Imaging Exchange (VIX) servers

If a local VIX server is accessible, VistARad will query the local VIX for relevant patient exams & ancillary information from other remote sites, including those in the DoD. If configured for remote site monitoring, VistARad will also periodically query the VIX for exam list information from the configured monitored sites. Additional information on configuring VistARad for VIX-enabled reading and list monitoring is available in the “VistARad Settings” and “Monitoring Exam Lists of Remote Sites” sections of the VistARad User Guide.

This page is intentionally blank.

Chapter 14 Package-Wide Variables

The VistA Imaging System does not contain any package-wide variables.

This page is intentionally blank.

Chapter 15 Online Documentation

15.1 Online Help

Online help is available from the Help menu for Clinical Display, Clinical Capture, MagSys (clinical workstation configuration manager), Background Processor, Verifier, VistARad, TeleReader, TeleReader Configurator, and DICOM Importer II.

This page is intentionally blank.

Chapter 16 Site-Specific Implementation

16.1 Site-Specific Implementation

16.1.1 Radiology Report Transcription Service

Local routines that automatically upload radiology reports from a transcription service should be reviewed and/or modified to ensure that proper consideration has been made for VistA Imaging. When an image is captured via the DICOM Image Gateway and the radiology case number does not have an existing radiology report entry (in file #74), then the VistA Imaging software creates a report stub entry for that case number with limited information. (See box below -- example of radiology report stub entry made by Imaging.) Please note that the stub report entry has an image pointer stored in the IMAGE field, no report status is on file and the activity log indicates that images were collected. The VistA Imaging System executes a Radiology Package API called CREATE^RARIC to create this entry. The RAD/NUC MED PATIENT file (#70) is also updated with the report pointer in the Report Text field.

Imaging has experienced problems when the auto-upload routine updates the REPORT TEXT field (#17) in the RAD/NUC MED PATIENT file (#70). Often the problems result from the program not expecting the Report file entry to exist at the time of the upload. However, the DICOM image capture process guarantees that at the time the transcribed reports are uploaded to the system, a Report file entry already exists, although no Report text nodes exist. Differences in implementations of the local upload programs at various sites have led to other problems as well. Therefore, if your site uses such a program for uploading and/or updating the Radiology report, you must carefully review all aspects of its functionality in light of the changes introduced by the VistA Imaging System.

```
DAY-CASE#: 031500-6666          PATIENT NAME: IMAGPATIENT,ONE
EXAM DATE/TIME: MAR 15, 2000@13:28  CASE NUMBER: 6666
DATE REPORT ENTERED: MAR 15, 2000
IMAGE: IMAGPATIENT,ONE 666-58-5533 FOOT 3 OR MORE VIEWS
CLINICAL HISTORY: pt s/p multiple 1st ray sx w/ continued pain. Please x-ray weight bearing
right foot.
LOG DATE: MAR 15, 2000@13:59      TYPE OF ACTION: IMAGES COLLECTED  COMPUTER USER: POSTMASTER
```

Example: Radiology Report stub entry made by the VistA Imaging application.

16.1.2 HL7 MESSAGE TEXT File (#772)

VistA Imaging is a subscriber to the Radiology protocols that create HL7 messages. When Radiology protocols are executed, entries are created in the HL7 MESSAGE TEXT file (#772). The purging of this file is handled by the menu option for this application. Sites are requested to review the purging parameters for this file. Use menu option 'Purge Message Text File Entries' under the HL7 Main menu.

16.1.3 Incomplete DICOM Files Received on the DICOM Image Gateway

During the processing of DICOM files on the DICOM image gateway, it is possible for a modality or a PACS interface to send an incomplete file (possibly just header information without the image information). The image processing routine will log these entries in a temporary file (M global) and check periodically to see if the entire file has been received. If, after an hour's time span, the file is still incomplete, the entry is removed from the temporary file

(M global) and the file is renamed by appending “_incomplete” to the filename. These files do remain in the DICOM\IMAGE_IN directory and will require site personnel to research the possible failure. In addition, these files will require manual intervention for file maintenance (deletion). Please see the *VistA Imaging DICOM User Manual* for additional information.

Chapter 17 Database Integrity Checking

The VistA Imaging System performs database integrity checking at the system level and within various applications.

17.1 VistA Imaging MAG SYS MENU

In the VistA Imaging system, the MAG SYS MENU has an Integrity Checker Menu with the following submenus:

- GM Global Move Inconsistency Report
- QA Pointer Inconsistency Report
- SC Scan Database for Integrity Issues

Where	Means
GM	Global Move Inconsistency Report [MAG_IC_RPT_GM] DESCRIPTION: Report from Imaging Integrity Check, limited to items required for Central Office ROUTINE: RPT^MAGCRPT("CO") UPPERCASE MENU TEXT: GLOBAL MOVE INCONSISTENCY REPO
QA	Pointer Inconsistency Report [MAG_IC_RPT_QA] DESCRIPTION: Report from Imaging Integrity Check, including all items required for Quality Assurance ROUTINE: RPT^MAGCRPT("QA") UPPERCASE MENU TEXT: POINTER INCONSISTENCY REPORT
SC	Scan Database for Integrity Issues [MAG_IC_SCAN] DESCRIPTION: Menu option to scan the Imaging database EXIT ACTION: K MAGN100,MAGZ,VALID,Z ROUTINE: RPT^MAGGSQI(.Z,1E11) UPPERCASE MENU TEXT: SCAN DATABASE FOR INTEGRITY IS

17.2 Clinical Display Application

The *Clinical Display Workstation User Manual* contains two references to Questionable Integrity (QI):

- A “Not Viewable” icon is displayed if the user attempts to view an image that has internal references that suggest some degree of integrity risk. For details, see the section Images That Are Not Viewable Due to an Error.

- An image that is blocked from view can be attributed to a number of reasons. One is if the image data does not pass the QI check, then the image is marked as QI. For details, see the section *Blocked Images* in the *Abstracts Window*.

Additionally, see the *Clinical Display Workstation User Manual* section *Deleting Images with Questionable Integrity (QI Issues)* in *Appendix C: Deleting Images*.

17.3 VistARad Application

The *VistARad User Guide* contains a reference to a “Severe Alert” icon that is displayed when a user attempts to view an exam and the system detects a data integrity problem with the exam. For details, see the section *Opening Exams*.

17.4 Verifier Application in the Background Processor

The BP Verifier provides a report called the *Imaging Patient Integrity Issues* in the *DFNError Log* file, which displays integrity issues with patient data. For details, see Section 5.7.1.4 *DFN Log File* in the *Background Processor User Manual*.

Chapter 18 Remote Image Views

18.1 Configuration for Remote Image Views

The Remote Image Views functionality uses a Network Location entry that points to the VistA Site Service to determine the server and port of remote VistA databases. This Network Location entry is present at all sites running Patch 45 or later. By default, this Network Location is enabled.

The URL defined in the VistA Site Service Network Location must be accessible to all clients attempting to access remote images.

Patch 111 provides the availability of the Broker Security Enhancement (BSE) for VistA Imaging clients. BSE is a token based authentication method that provides enhanced security over the previously used CAPRI login method.

Patch 94 modifies remote image view functionality in Display and TeleReader to make use of BSE. The client will first use BSE when attempting to connect to remote sites. If BSE fails, the client will use the CAPRI remote site login. When CAPRI is used, the system will generate a log entry to track the usage of the CAPRI authentication method. Using the BSE or CAPRI remote login method does not affect the usability of the applications, and it is transparent to the user.

The Kernel Team will release a patch to disable the CAPRI authentication method after Patch 94 is released. When the Kernel Team disables the CAPRI authentication method, only clients 94 and later will be able to connect to sites for remote image viewing.

18.1.1 Enabling/Disabling Remote Image Views for Site

To enable/disable Remote Image Views for your entire site, you may do so by changing the Operational Status of the NETWORK LOCATION file (#2005.2). Setting the Operational Status to On-Line enables Remote Image Views for your entire site. Setting the Operational Status to Off-Line disables Remote Image Views for your entire site. Enabling and disabling this option does **not** prevent remote sites from accessing your data. This only prevents users at your local site from accessing remote data.

```
If you would like to disable Remote Image Views at your local site, you may do so by modifying the Operation Status field of the VISTASITESERVICE NETWORK LOCATION.
```

```
VA FileMan 22.0
```

```
Select OPTION: ENTER OR EDIT FILE ENTRIES
```

```
INPUT TO WHAT FILE: NETWORK LOCATION// NETWORK LOCATION  
(60 entries)
```

```
EDIT WHICH FIELD: ALL// OPERATIONAL STATUS  
THEN EDIT FIELD:
```

```
Select NETWORK LOCATION: VISTASITESERVICE  
http://siteserver.med.va.gov/VistaWebSvc/SiteService.asmx
```

```
OPERATIONAL STATUS: On-Line// ?  
Code the Network Location Online/OFFline status  
Choose from:  
0 Off-Line
```

```
1 On-Line
OPERATIONAL STATUS: On-Line// ??
```

To allow clients at your site to use Remote Image Views, set the VISTASITESERVICE Operational Status to **On-Line**. If you would like to disable Remote Image Views at your site, set the Operational Status to **Off-Line**.

18.1.2 Updating VistA Site Service URL

The remote image viewing capability uses a VistA Site Service to determine the server details of remote VistA systems. The following describes how to change the URL for this service if necessary.

If the VistA Site Service URL needs to be changed, you will need to edit the Physical Reference field for the VISTASITESERVICE entry in the NETWORK LOCATION File.

Example Fileman session:

VA FileMan 22.0

Select OPTION: **ENTER OR EDIT FILE ENTRIES**

INPUT TO WHAT FILE: **NETWORK LOCATION// NETWORK LOCATION**
(60 entries)

EDIT WHICH FIELD: ALL// **PHYSICAL REFERENCE**
THEN EDIT FIELD:

Select NETWORK LOCATION: **VISTASITESERVICE**

http://siteserver.med.va.gov/VistaWebSvc/SiteService.asmx

PHYSICAL REFERENCE: http://vhaann26607.v11.med.va.gov/VistaWebSvc/SiteService.asmx
Replace ??

You can modify the value for the Physical Reference field to the new URL of the VistA Site Service. Appendix A Error Messages

Chapter 19 Two-Factor Authentication (2FA)

19.1 Two-Factor Authentication (2FA) Overview

SSOi implemented by replacing the existing RPC Broker for those VistA Imaging applications that require VistA login credentials to access. The VistA Imaging login interface and workflow has changed from username and password to PIV card and PIN entry as part of the 2FA mandate. VistA Imaging components currently consume and reference a Delphi RPC Broker Development Kit (BDK) including a compiled BAPI32.DLL library. This RPC library exposes several procedure calls used to authenticate a user within a VistA application. As part of the VistA Imaging SSOi effort, we will be upgrading this library and BDK, (expected version XWB*1.1*65 currently in development and beta testing), which will have built-in integration to the IAM SSOi Secure Token Server (STS) authentication model including PIV/PIN prompt(s).

19.1.1 PIV/PIN Login

Figures 1 and 2 represent the screens that will display during login with 2FA SSOi integration. The user must have a valid PIV card attached to their computer, select the corresponding identity certificate, and enter their PIN.

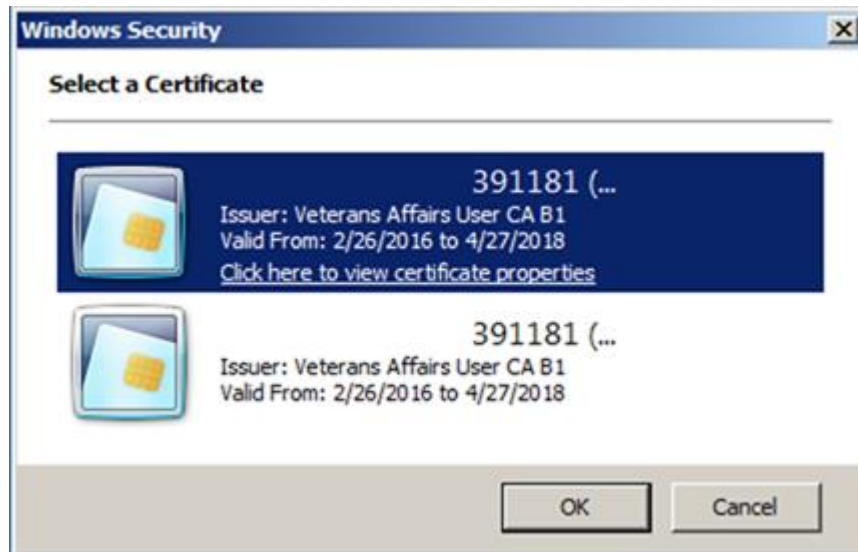

Figure 1: PIV Identity Certificate Selection Display

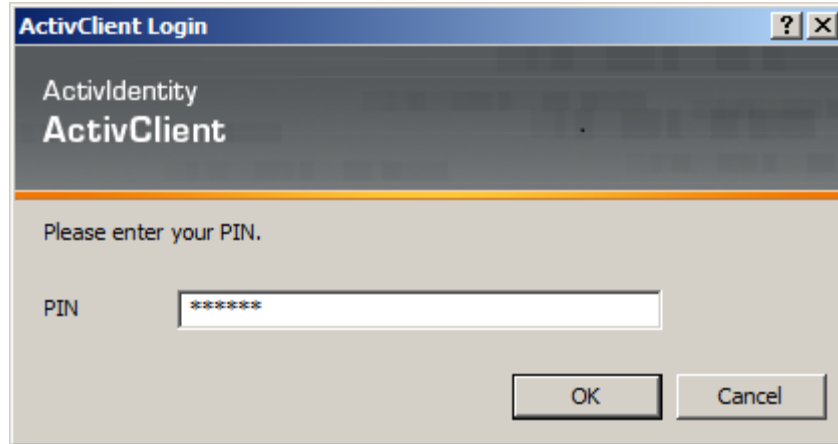

Figure 2: PIV PIN Entry Display

19.2 Implementation History

MAG*3.0*178 introduced 2FA for the Clinical Capture application, replacing username and password login process.

MAG*3.0*181 introduced 2FA for the Clinical Display application, replacing username and password login process.

MAG*3.0*182 introduced 2FA for the Telereader application, replacing username and password login process.

MAG*3.0*184 introduced 2FA for the VistARAD application, replacing username and password login process.

MAG*3.0*206 introduced 2FA for the Importer application, replacing username and password login process.

Appendix A Error Messages

A.1 Clinical Workstation Error Messages

Error Message	Cause(s)/Solutions
You don't have the proper Security Keys to capture LAB images.	The USE CAPTURE KEY field in the IMAGING SITE PARAMETERS file (#2006.1) has been turned on and the user has not been assigned the proper key. Please review the Security Key section in the <i>Vista Imaging Security Guide</i> .
Error in connecting to Server \\servername\image\	Possible causes: <ul style="list-style-type: none"> • The workstation has not been set up properly. • The account used to access the server has not been given the proper security level or has not been set up properly. • The listed server is down. Find the associated error number and use the Help Error Code Lookup option in Imaging Display.
AutoUpdating is disabled. Network Configuration file doesn't exist.	The MAGNET.ini file is not on the Network Update directory. Auto Update is not configured properly. <ol style="list-style-type: none"> 1. Contact network administrator and request that a copy of the MAGNET.ini file be placed in the Network Update directory. 2. Review the Vista Imaging System Installation Guide for proper configuration of Auto Update.
AutoUpdating disabled. The network update directory doesn't exist.	Cannot connect to the directory or it does not exist. <ul style="list-style-type: none"> • User does not have privileges to the distribution directory. • Workstation log-on profile does not connect to Network Update directory. • Contact network administrator.
AutoUpdating disabled. Workstation isn't configured for Auto Updating.	No update directory in the MAG308.ini file under section SYS_AUTOUPDATE for variable DIRECTORY. Run MAGASET.EXE from the Network Update directory. This will automatically define the DIRECTORY entry in the MAG308.ini file for the current workstation.

Error Message	Cause(s)/Solutions
<p>AutoUpdating canceled. No Updates available.</p>	<p>The MAGSETUP.EXE file does not reside in the Network Update directory. Contact the network administrator and request a copy of the MAGSETUP.EXE file be placed on the Network Update directory.</p>
<p>Abstract not found.</p>	<p>Possible causes:</p> <ul style="list-style-type: none"> • The abstract was removed from the server. • The abstract was not generated, or could not be written to the share. • Network problems. • Mapped Image share • Permission to access the share is not granted. <p>Diagnostic process and corrective action:</p> <ul style="list-style-type: none"> • Check file and folder permissions for the image shares. • Check to see if the files exist on the shares.
<p>ERROR_ACCESS_DENIED</p>	<p>Possible causes:</p> <ul style="list-style-type: none"> • Account or share permissions are not set up properly. • Account password was changed on the server, but not updated in the IMAGING SITE PARAMETERS file (#2006.1).
<p>Error connecting to server.</p>	<p>Possible causes:</p> <ul style="list-style-type: none"> • Incorrect configuration. <p>Diagnostic process and corrective action:</p> <ul style="list-style-type: none"> • Check for error number in the message history window. Look it up using the Error Lookup option on the Imaging Display help menu. • Use ping or tracert to check the availability of the file server.

Error Message	Cause(s)/Solutions
0 Images on file.	<p>Possible causes:</p> <ul style="list-style-type: none"> • Normal condition. <p>Diagnostic process and corrective action:</p> <ul style="list-style-type: none"> • This refers to images, not EKGs! A patient can have one without the other. Check "user preferences" to see if "always display EKG window" is selected. Click the EKG button to display the EKGs.
The File Does Not Exist - Notify IRM.	<p>Possible causes:</p> <ul style="list-style-type: none"> • Missing or inaccessible file. <p>Diagnostic process and corrective action:</p> <ul style="list-style-type: none"> • Check to see if the file pointed by the database exist and is accessible.
Launching Imaging from CPRS causes RPC Broker dialog for access/verify code.	<p>Possible Causes:</p> <ul style="list-style-type: none"> • Incorrect configuration. <p>Diagnostic process and corrective action:</p> <ul style="list-style-type: none"> • AutoSignon or multiple signon is not enabled for the site (KERNEL SYSTEM PARAMETERS file (#8989.3)) or the user (NEW PERSON file (#200)). • DEFAULT AUTO SIGN-ON cannot be set to "Disabled" in Kernel site parameters file.
Error Accessing Group Image - See VistA Error Log.	<p>Possible causes:</p> <ul style="list-style-type: none"> • Database inconsistency. <p>Diagnostic process and corrective action:</p> <ul style="list-style-type: none"> • This error is found on the clinical display when you try to delete an "Abstract not Found" entry. The software identifies this entry as a group image and because you cannot expand the group, it cannot be deleted.

Error Message	Cause(s)/Solutions
<p>No MUSE Servers available.</p>	<p>Possible causes:</p> <ul style="list-style-type: none"> • No MUSE servers are configured in the Network Location file (#2005.2). • All MUSE servers in the Network Location file are configured as off-line. <p>Diagnostic process and corrective action:</p> <ul style="list-style-type: none"> • Add the MUSE Servers to the Network Location file. • Bring the MUSE servers back On-Line in the Network Location file.
<p>No MUSE Servers available. Select a failed connection to see the error code.</p>	<p>Possible causes:</p> <ul style="list-style-type: none"> • The application failed to connect to the all of the MUSE Servers. • MUSE servers are down. <p>Diagnostic process and corrective action:</p> <ul style="list-style-type: none"> • Click on a specific connection to see the error details.
<p>No Muse EKGs on File for this patient</p>	<p>Possible causes:</p> <ul style="list-style-type: none"> • Patient ID (SSN) entered does not match MUSE patient ID. • The Patient has no Muse EKGs on file. <p>Diagnostic process and corrective action:</p> <ul style="list-style-type: none"> • Verify that the entered patient ID (SSN) is identical in the MUSE and VistA databases.
<p>Error connecting to MUSE Server \\<ServerName>\<ServerShare>: status =53</p>	<p>Possible causes:</p> <ul style="list-style-type: none"> • The network path was not found. • Permission problem on share. • MUSE server down. <p>Diagnostic process and corrective action:</p> <ul style="list-style-type: none"> • Be sure you can ping the server. • Ensure that the Physical Reference field in the Network Location file (#2005.2) is defined correctly.

Error Message	Cause(s)/Solutions
Error connecting to MUSE Server \\<ServerName>\<ServerShare>: status =104	Possible causes: <ul style="list-style-type: none"> • Error message displayed when user selects a failed connection in the EKG selection list. The MUSE API flag is not enabled. Diagnostic process and corrective action: <ul style="list-style-type: none"> • This requires a call to GE so they can enable the API by installing a VOL000\system\sysinf\MUSEAPI.FIX file. • If this file was created with Notepad, be sure that it is not named MUSEAPI.FIX.TXT. Notepad adds a .txt extension when it creates a file.
Invalid File : MUSEAPI.DLL Call IRM to get an updated file.	Possible causes: <ul style="list-style-type: none"> • The MUSE API files were not installed correctly. • The MUSE API files are not installed. Diagnostic process and corrective action: <ul style="list-style-type: none"> • Call IRM for help • Reinstall VistA Imaging.

A. 2 Troubleshooting

General Startup

Network Connection

Check all the online VistA Imaging Tier 1 shares and Tier 2 shares by one of the following means to determine if the BP has access to the folders/files on the shares. There are several methods to test the connectivity:

1. From the Main BP window, select the **View > Server Size** option.
The free space should display for each share.

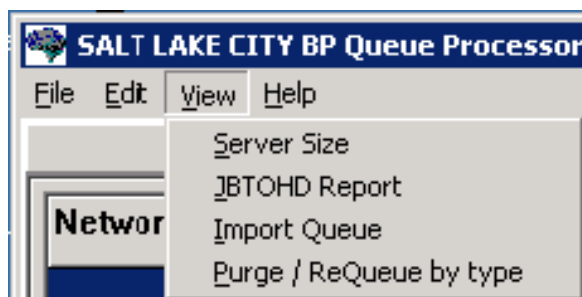

2. Using Windows Explorer on the destination device (Image cluster or Windows-based Jukebox server), show the properties of the VistA Imaging Tier 1 shares and Tier 2 shares.

The VHAxxxIA account that is used to log into the BP Server should have READ/WRITE access to both the shares and folders/files on those shares.

Note: For sites using the Archive Appliance (AA), contact the HP Expert Center.

3. Open a DOS window. At the command prompt type `dir \\server\share` (the server could be a cluster server or the jukebox server). Traverse down a couple folders under the main level the folders/files should be visible
4. If any of these methods fail, open a DOS window and use the DOS `ping` command to see if the server is accessible on the network.
5. If the server is accessible, try mapping the share thru Windows Explorer. Explorer will display any error messages. If the server is not accessible, contact the network admin to troubleshoot.

Broker Failures

When the connection to the Broker fails:

- Verify the PORT and Server are correct in the registry
- Close and restart the application.
- Open a DOS window and use the `ping` command to see if the VistA server is available
- Verify that the listener is running in VistA
- Validate that the Access/Verify codes have not expired.
- Check the security on the Access/Verify account. Make sure:
 - The MAG SYSTEM security key is assigned
 - The All MAG* RPC's [MAG WINDOWS]menu option is assigned

Not Enough Server Cache

This message indicates that:

- The share on the server is not accessible. Follow the steps in section [0 Network Connection](#) to troubleshoot.
- The free space on the Image shares is below the % Server Reserve.
 - Disable the Auto Write Location Update option.
 - Set the write location manually to a share with cache space available.
 - If no share has adequate free space, create a second BP Server and manually launch a Purge (in **Error! Reference source not found. Error! Reference source not found.**) to run on all shares. When the Purge has run and generated free space on a share, set the Write location manually to that share.

Not Enough Process Memory

Close all the applications and reboot the server. If the problem persists, contact the National Helpdesk.

Not Enough Write Cache Available

This message refers to the DiskXtender cache on the jukebox and indicates there is no free space on the jukebox share, or for Archive Appliance sites a possible space issue exists.

- Verify the share is accessible. Follow the steps in section *0 Network Connection* to troubleshoot.
- Click the Extended Drive in DiskXtender to see if there is free space available. Also, use Windows Explorer on the JB server to see if Windows is properly reporting free space.
- Check the Move Group within the DiskXtender application to see if there are platters with available space. If not, add additional optical platters to the Move Group. See the *DiskXtender User Manual*.
- Run a Drive Scan on the share. See the *DiskXtender User Manual*.

A. 2.1 Queue Processor Startup

Message	Explanation	Action
Create Process failed'+ProgramName	A system error occurred starting the process	Follow your local, VISN, or regional procedures for problem resolution/escalation
Increment <i>queue_name</i> Ptr^Failed	The QUEUE POINTER (#1) in the IMAGE BACKGROUND QUEUE POINTER file (#2006.031) in VistA could not be updated	On the main BP window, use the Edit > Refresh Queue Counts to correct the current counts. Close the BP and restart the application.
Initialization Failure^Log Files at: C:\Program Files\Vista\Imaging\BackprocLog\BackProc\BPError.log	Log file could not be created	Check permissions on the log folder
RAID groups not properly configured	An active RAID Group has no online shares	Make sure online RAID Group has online shares. Use the Network Location Manager to reset your RAID groups
Requeue Failure trying to Requeue:	An attempt to re-queue a failed queue entry failed	Use the Queue Manager and step past the queue entry. Determine the problem with the entry that would not re-queue.

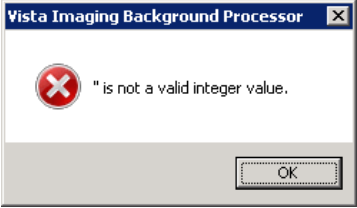
Message	Explanation	Action
SetTime Handle – Destin: C:\Program Files\Vista\Imaging\BackprocLo g\BackProc\BPError.log Access is Denied	Could not write the Access Date on the log file	Check the file permissions on the log folder listed.
The Background Processor client software is version <i>n.n.n.n</i> . VistA Imaging Host system has version <i>m</i> installed. Please update to compatible client and host software. Shutting down the Background Processor...	The client software that is installed does not match the KIDS version installed on VistA.	Install the correction version of the KIDS and client software.
The Patch 135 KIDS install on the VistA host system is required for this Version of the: <i>site name</i> BP Queue Processor	The KIDS file for this most recent patch has not been installed in VistA.	Install the KIDS file on VistA.
The Site parameter context could not be determined. The application will terminate.	The PLACE global is corrupt	Follow your local, VISN, or regional procedures for problem resolution/escalation.
	The Broker is not properly configured in the registry of this server.	Edit the registry on this server to meet the connection requirements on the host server with proper host server name and port number. Note: on 64 bit OS the hive is [HKEY_LOCAL_MACHINE\SO FTWARE\Wow6432Node\Vista\B roker\Servers]
This server is not yet configured for BP queue task processing!	There is either no BP Server name with this network name in the BP Server file (#2006.8) or there are no task(s) assigned to this server	Create a BP Server through the GUI and assign tasks to it BP Servers menu/tab
InitLogFile: procedure NewCreationDate SetFileTime Failed <i>WIN32_Error</i>	Log File Initialization error	See above The log files should not have a local drive in the BP Server Parameters. The designated path should be a network share. Note: The Computer name is automatically set by the application software. Setting the server name in the parameter will create a confusing duplicate descendant server tree on the Network share.

A.2.2 Runtime

Message	Explanation	Action
0^AccuSoft Control creation error : < error message >	The Import API uses the AccuSoft Image Gear Toolkit to create the watermarked image. If an error occurs during the creation of AccuSoft controls, the error message displays describing the error.	The AccuSoft controls are installed during MAG*3.0*135 installation. If this error message occurs, contact the Vista Imaging system manager.
0^Image is missing from input data.	The image to be watermarked is not in the Import Queue Data.	Check the IMAGE file (#2005) to see if the data is corrupt.
0^Watermark failure : <error message>	The process of burning the “Rescinded” watermark onto the image file failed.	The AccuSoft ToolKit could not create the watermarked image. Check if the rescinded bitmap exists in the image directory C:\Program Files\vista\Imaging\Bmp\MagRescinded.bmp. You may need to reinstall MAG*3.0*135 to correct AccuSoft ImageGear problems.
An Abstract for this file is on the Jukebox, a JBTOHD is being queued	ABSTRACT - The abstract pointer on the Tier 1 is empty. The abstract will be copied from the jukebox	None
Could not complete	DELETE - file could not be deleted	Check permissions on Tier 1 share
Could not complete/Requeued	DELETE - file could not be deleted	Check permissions on Tier 1 share
Current Tier 1 Shares^Exception: No RAID group Assigned	The Tier 1 share must be assigned to a RAID Group	On the BP main window, use Edit > Network Location Manager to assign the Tier 1 share(s) to a RAID Group.
False Positive Copy <i>filename(Source), filenames source file size, file size(jukebox)</i>	File sizes on source and destination don’t match. File not copied.	Determine if images are for different patients
File copied was of size zero	IMPORT - The file size is zero	Resend image from import source

Appendix A – Error Messages

Message	Explanation	Action
File of size zero created then deleted	MAKEABS - file of zero length was created by Mag_MakeAbs.exe. It was deleted.	Follow your local, VISN, or regional procedures for problem resolution/escalation
File was not found	IMPORT - file does not exist on the image share	Resend image from import source
<i>filename</i> Source file does not exist.	Could not find source file	Run Verifier to correct VistA pointers
<i>fileshare</i> : Cannot connect to the Export Share.	EXPORT - Cannot map to the remote share	Check for network connectivity. Check permissions..
ForceDirectories failed:	DELETE - could not create directory on jukebox share	Check permissions on jukebox share
Image File type: <i>filename.ext</i> is an Unsupported Format	ABSTRACT - The Full file is not a supported Imaging file type. So the abstract cannot be created.	Examine the "foreign" file and determine if the extension was misnamed.
Invalid Imaging Network Username or Password.	The BP processor operator does not have write permissions on Tier 1, Tier 2, the Network Log file share, or the IMPORT share.	Check permissions on the share the write share associated with this error.
Jukebox is not available: <i>filepath Volume label</i>	Tier 2- the jukebox share is not available	Ping the jukebox server. Check the jukebox share permissions.
Jukebox sourcefile unavailable	JBTOHD - There is no abstract file on the jukebox. The abstract pointer in VistA is not set.	None
JUKEBOX: <i>queue _pointer ^file_extension</i> Not copied	JUKEBOX - Alternate file extension (i.e. .TXT) was not copied	Check file permissions
Login Message^Pausing 3 minutes and will then retry	AUTOLOGIN - could not relog into the Broker	Check for network connectivity.
Login Message^Silent Login attempt failed!	AUTOLOGIN - could not relog into the Broker	Check for network connectivity.
Make AbstractError / abs is already present	ABSTRACT- file already exists at the Tier 1 location specified in VistA	None
Make AbstractError / <i>filename</i>	MAKEABS- the Mag_MakeAbs.exe could not create the abstract file	Follow your local, VISN, or regional procedures for problem resolution/escalation

Message	Explanation	Action
NetConError Using User credentials <i>WIN32_Error</i>	GCC - Could not logon to the remote location with the Username/Password in VistA	Correct the Username/Password for the GCC location in VistA
NetConError, There is no password associated with this Network Location: <i>share_name</i>	GCC - The password field is empty for this Network Location	Enter a password for this GCC location
No Image file entry was created!	IMPORT - an IEN was not created in the image file	Resend image from import source
No Jukebox sourcefile available / Attempting Abstract Queue	JBTOHD - There is no abstract file on the jukebox. The abstract pointer in VistA is set. The Queue Processor will attempt to make on from the Full or BIG file.	None
No Tracking ID IMPORT failed	IMPORT - unique Tracking ID parameter is missing from IMPORT	Resend image from import source. Use the Queue Manager to check the Import queue Properties for failed IMPORTS.
Problem renaming log file: <i>filename</i>	Could not rename log file to a versioned copy	Check permissions on the existing folder/files
<i>queue_pointer</i> ^Size Mismatch <i>queue_type</i> copy not overwritten.	File sizes on source and destination don't match. File not copied.	Determine if images are for different patients
SetFileTime Failed	Could not set Access date on the log file.	None
The BP Queue executed a scheduled RAID Group Advance	The Queue Processor performed a the scheduled RAID Group Advance to the next group with adequate free space per the site parameter configuration	Verify that the tape backup schedule are synchronized with this Tier 1 write location update
The BP Queue executed an automatic RAID Group Advance	The Queue Processor performed an automatic RAID Group to the next group with adequate free space per the site parameter watermark configuration	Verify that the tape backup schedule are synchronized with this Tier 1 write location update
The jukebox copy: <i>filename</i> does not exist -- attempting a copy...	DELETE -Could not find the file on jukebox shares. Try to copy from Tier 1 shares to jukebox	None
The RAID share is not on-line	IMPORT - The Tier 1 share is not available	Check the permissions on the image share indicated

Message	Explanation	Action
The <i>src_filename</i> to <i>dest_filename</i> copy failed.	EXPORT - file could not be copied	Check for network connectivity. Check permissions.
The VistA cache file: <i>filename</i> not found	DELETE -Could not find the file on Tier 1share to delete	None
This Server is not yet configured!	A BP Server has not been associated with this server.	Create a BP Server for this processor
Unable to copy to the Jukebox: Not enough write cache available	JUKEBOX - The Tier 2 share is not available or is full	Add new platters to the jukebox. Determine why the Tier 2share is full. Possibly add new platters to the jukebox.
Zero size <i>queue_type</i> copy NOT overwritten	Zero size file on the destination could not be overwritten	Remove zero size file
No Connection to VISTA	The VistA Access and Verify codes of the user or service account are invalid.	Update the Access and Verify codes on the BP Site parameter window.

A.2.3 Verifier

Start/Run

Message	Explanation	Action
About to exit without processing: 0	There are no IEN records within the range.	Choose another IEN range
Broker Connection to server could not be established!	VistA RPC Broker is not currently in a listening state OR the application has timed out.	Close the application and restart. Check with the VistA system manager for the status of the Broker listener.
CC:createcontext ("MAG WINDOWS") could not be established!	The user does not have All MAG* RPC's [MAG WINDOWS] menu option assigned.	Assign the user this menu option.
lbCacheShare.items.Count < 1: MAGQ SHARES	There are no online, non-router VMC shares.	Use the Queue Processor's Network Location Manager to check/add the shares.
Invalid Input Range	The From and To values entered in the Range are not correct (e.g. Start: 0 End: 0).	Enter a valid <i>From</i> and <i>To</i> range.
jukebox shares are not setup	The Tier 2 share(s) are offline or don't exist in the NETWORK LOCATION file (#2005.2).	Create/Edit the Tier 2 shares in the Network Location Manager on the Queue Processor.
This workstation is not currently setup as a Background Processor.	There is no BP Server set up for this machine.	Use the option <i>BP Servers</i> on the Queue Processor to register this server.

Message	Explanation	Action
Verifier client software is version nnn. VistA Imaging Host software is version mmm. Please update to compatible client and host software. Shutting down Verifier...	The version of the KIDS file installed on VistA does not match the executable version on the workstation.	Install the latest KIDS and client software.
VistA shares are not setup	The image share(s) are offline or don't exist in the NETWORK LOCATION file (#2005.2).	Create/Edit the shares in the Network Location Manager on the Queue Processor.

A. 2.4 Output HTML Messages

Message	Explanation	Action
Aggregate JB Copy Error:	Could not copy from alternate Tier 2 to the current Tier 2 Write location.	Check permissions
Abs to JB:	Abstract has been created and copied to the jukebox	None
Aggregate Function - Enabled	Software is enabled to copy files from secondary jukebox, if necessary	None
BIG Aggregate Failed	Could not copy BIG file from secondary jukebox	Check file existence/permissions
Create Process failed	Could not create process on VistA for Verifier	Check Error Trap
Empty FBIG node	"FBIG" node has no pointers set in IMAGE file (#2005) record.	Check shares for existence of BIG file. If not found, restore BIG file from backup tapes.
File of size zero created then deleted	Abstract file created of size zero. Then it is deleted. (Likely corruption of BIG and/or TGA file)	None
FULL Aggregate Failed	Could not copy FULL file from secondary Tier 2.	Check file existence/permissions
FULL Aggregate Failed	Could not copy FULL file from secondary Tier 2.	Check file existence/permissions
Images JB share is OFF-LINE:	Tier 2 is offline	Set Tier 2 back ONLINE
Make AbstractError	Abstract file could not be created from TGA/BIG (BIG/TGA not found or image file corruption).	Check shares for existence of BIG/TGA file. If not found, restore BIG/TGA file from backup tapes.
New Abs to CWL	An abstract file has been created and copied to the current write image share	None
No ABS file VC Ptr Cleared	Abstract file not found on the Image share	None

Message	Explanation	Action
No ABS file VC Share OFF-Line	Image share is offline at location of abstract file	Set share back online and re-run Verifier
No ABS JB Files	No abstract file found on Tier 2	Check shares for existence of ABS file. If not found, restore ABS file from backup tapes
No Acquisition Site in Image file	The ACQUISITION SITE field #100 in the IMAGE file (#2005) is missing. This is a required field.	Contact IRM Update the field with the proper site ID.
No FULL JB Files	FULL file not found on the Tier 2	Check shares for existence of Full file. If not found, restore Full file from backup tapes
No FULL VC Files	FULL file not found on the Tier 1 share	None
No jukebox BIG Files	BIG file not found on the Tier 2	Check shares for existence of BIG file. If not found, restore BIG file from backup tapes.
No jukebox FULL Files	FULL file not found on the Tier 2	Check shares for existence of Full file. If not found, restore Full file from backup tapes.
No Network References	No IMAGE file (#2005) record exists for this image	Re-import image thru the Capture client
No Network References: Archived Image	Image has been archived, resides in the IMAGE AUDIT file (#2005.1)	None
No VC BIG Files	Could not find the BIG file on the Tier 1 share	None
Not Certed	Could not find/create file type on Tier 2	Check shares for existence of BIG file. If not found, restore BIG file from backup tapes.
Problem rename log file:	Permission problem with log file	Set WRITE permissions set on share/folder/file for Windows login account.
Text file Patient ID not in VistA	Could not locate patient ID in VistA	Contact IRM
TXT to BIG VC	Copy TXT file to same share as BIG file	None
TXT to FULL VC	Copy TXT file to same share as FULL file	None
"Check Text" Option Messages		
Text File Corruption Error Type 1:	Text file is binary or unreadable	Restore file from Tier 2/backup tapes
Cannot determine Text file type:	Foreign text file was not likely generated on the image gateway	Restore file from Tier 2/backup tapes
Text File Corruption Error Type 2:	Text file is ASCII but has unprintable characters or truncated	Restore file from Tier 2/backup tapes
Text/Image DFN Mismatch:	Patient ID in text file does not match that in VistA	Future utility patch

Message	Explanation	Action
Text/Image SOP/UID Mismatch	The Series Instance UID in the text file does not match the one in VistA	Future utility patch
Text/Image Study/UID Mismatch	The Study Instance UID in the text file does not match the one in VistA	Future utility patch
Text/Image UID Mismatch	SOP and/or Study UID are/is blank in text file	Future utility patch
Updated Text file	Text file has been edited	Validate file has been copied to Tier 2
No SSN Found	Patient ID field missing in text file	Future utility patch

A.2.5 Integrity Messages on Patient Data

There are integrity issues that will prevent their respective images from being displayed and others that will not impact the viewing. See Appendix C for sample output.

A.2.5.1 Conditions Preventing Viewing

An integrity error message will be generated when the image is retrieved for viewing on these conditions and the patient image will not be viewable until the condition is corrected or the user has the proper key to view these images.

Message	Explanation	Action
No Image Ptr in AP	The Clinical Association Report (AP) for this image does not contain an image entry that points back to this image.	Future utility patch
GP has no images	Image series that does not contain any images. Group Parents (GP) are containers for an Image series. A group parent with NO group objects (GO) is an invalid condition.	Future utility patch
Conflicting AP & Image DFNs	The patient file reference (DFN) in the Clinical Association Report (AP) does not match the DFN in the IMAGE file (#2005).	Future utility patch
Invalid Image Ptr to AP	The Clinical Association Report (AP) has image references that are not in the IMAGE file (#2005).	Future utility patch
Conflicting GP and GO DFN	The patient file reference (DFN) in the Group Parent (GP) is not the same as the DFN in the Image entry.	Future utility patch

Appendix A – Error Messages

Message	Explanation	Action
GP & GO AP Mismatch	The Group Parent and Group Object pointer references to a Clinical Association Report (AP) do not match.	Future utility patch
GP Missing GO Ptr	The Group Object multiple of the referenced Group Parent does not reference this group object.	Future utility patch
No AP Mult Ptr	This Image entry does not have the clinical application (AP) image multiple entry number specified. The IMAGE file (#2005).record is missing the <i>PARENT DATA FILE IMAGE POINTER</i> (#17) for a Clinical Association Report (AP).	Future utility patch
GO DFN mismatches	Some image file Group Objects have different PATIENT references (DFN).	Future utility patch
Image entry is structurally abnormal	The normal structure that distinguishes Image entry Group Parents (GP), Group Objects (GO), and Non-Group image (NG) is corrupt.	Future utility patch
Missing Group Objects	The Group Parent has Group Object references that are missing.	Future utility patch
DFN Mismatches in AP Image Mult	The Clinical Association Report (AP) references a Group Parent that has image files with a different PATIENT reference (DFN) than the report.	Future utility patch

A.2.5.2 Conditions Allowing Viewing

The following integrity issues will **not** prevent their respective images from being displayed. These are informational messages.

Message	Explanation	Action
No AP Ptr	The IMAGE file (#2005) record is missing the PARENT DATA FILE# (#16) for a Clinical Association Report (AP). This Image does not have the entry in the clinical application (AP) specified.	Future utility patch
No AP entry Ptr	This Image does not have the entry in the clinical application (AP) specified. The IMAGE file (#2005) record is missing the <i>PARENT GLOBAL ROOT DO</i> (#17) for a Clinical Association Report (AP).	Future utility patch

A.2.4 Purge

Message	Explanation	Action
Broker Reconnection failed	Auto login after a Broker disconnect failed	Check network. Contact IRM
Create Process failed <i>ProgramName</i> ,	Windows failed to create a process.	Reboot the server.
Express Purge Rate limit reached: <i>PurgeRate</i> on share: <i>CurrentShare</i>	The purge terminated on the given share because Express Purge was active and the Purge process exceeded the user defined purge rate.	None
File Delete failure: <i>filename</i>	The file listed could not be deleted.	Check permissions on the share/folder/file
File in use: <i>filename</i>	The log file is in use	Exit from the Purge and restart
File purged: <i>filename</i> . 'The Image file (#2005) was not updated'	The file was deleted on Tier 1, but the pointer in VistA could not be updated.	Validate the IEN record exists in VistA.
Findfirst failed <i>filename</i>	The directory traversal failed	Exit from the Purge and restart
Log File Archival reset to: <i>FilePath2</i> instead of: <i>FilePath1</i>	The logs files are now being stored at another location.	None

Message	Explanation	Action
Login Message^Broker Reconnection Successful	After a Broker disconnect, the application was able to reconnect to VistA.	None
Login Message^Pausing 3 minutes and will then retry	After a Broker disconnect, the application tries 3 times to reconnect to VistA	None
Login Message^Silent Login attempt failed!	After a Broker disconnect, the application was not able to reconnect to VistA.	Check network connections.
NewCreationDate^SetFileTime Failed <i>filename</i>	Could not set the date of last Access on filename	None
Non-Connection related Broker error	Broker disconnected	Check VistA for error trap
NOT Purged criteria: <i>EvalCriteria</i> NOT PURGED- JUKEBOX QUEUED <i>filename date</i>	File was not deleted. See Section 6.4 Purge Criteria.	None
Problem renaming log file <i>filename1 -> filename2</i>	Could not rename log file to versioned log file name	Check permissions.
Purge Criteria: <i>EvalCriteria filename filedate</i>	See Section 6.4 Purge Criteria	None
Purge Criteria: <i>EvalCriteria</i> NOT PURGED <i>filename filedate</i>	File was deleted. See Section 6.4 Purge Criteria	None
Silent Login attempt	Broker was disconnected. Auto login is initiated.	None
Start Date failure	Problem with Date of Last Purge on Scheduled Purge	Contact IRM to clear the record in the Imaging Site Parameter file (#2006.1).

A.2.5 Import API

The Import API OCX (IAPI OCX) traps System Error Codes in all of the Windows function calls that are made during Import processing. When an Error occurs, the Error Code and Error Description are listed in the Result Array that is returned by the Import API.

Descriptions of the error codes are returned using the Windows function: GetLastError.

Note: The System Error Codes are very broad. Each one can occur in one of many hundreds of locations in the system. Consequently the descriptions of these codes cannot be very specific. Use of these codes requires some amount of investigation and analysis. Make note of the run-time context in which these errors occur.

Along with the System Error code and description, the values of other IAPI parameters will also be listed in the Result Array when an error occurs. The other values will help determine the exact cause of the error.

Not all of the values listed below will be returned in the Result Array. Depending on the type of error, some values will be listed while others may or may not exist at the point in the process when the error occurred.

An example of this is the Access Verify codes. These values will be listed if an error occurs during login to the database only.

Other values include:

- Import Queue number
- Image Share File Path
- Password
- Tracking ID
- Server\Share Name
- Access Code
- File to Import Full Patch
- Username
- Verify Code

Example

The following is an example of returned Error array

```
(0): 0~ERROR: 0 Images copied
(1): MAG135;20130122 12:31:21-43      << Tracking ID
(2): 21                               << Import Queue Number
(3): ----- Image Security for Filename: \\vhaiswclu4\User1$\TestImages\CardioMR.jpg
(4): ----- ParseServerShare: Input= \\vhaiswclu4\User1$\TestImages\CardioMR.jpg
(5): ----- ExtractFilePath : \\vhaiswclu4\User1$\TestImages\
(6): ----- Result \\Server\Share: \\vhaiswclu4\User1$
(7): ----- Confirming UserName and Password...
(8): ----- Username: vhamaster\vhaiswIU Password Access1.
(9): ----- OSConnectToServer Start : 1/22/2013 12:32:35 PM
```

(10): ----- GetLastError: 1219 - Multiple connections to a server or shared resource by the same user, using more than one user name, are not allowed. Disconnect all previous connections to the server or shared resource and try again

(11): ----- Credential conflict, continuing as current User...

(12): ----- OSConnectToServer Success: 1/22/2013 12:32:35 PM

(13): ----- Success: Image Directory is accessible. \\vhaiswclu4\User1\$

(14): Error copying \\vhaiswclu4\User1\$\TestImages\CardioMR.jpg
to Server : 30168~\\isw-kirin-It\image1\$\GFB0\00\00\03\01\~GFB00000030168.JPG

(15): :File doesn't exist : \\vhaiswclu4\User1\$\TestImages\CardioMR.jpg

(16): 1~VistA Image Entry deleted: 30168

(17): 1~Status Callback was called

The most common types of errors that will occur in the IAPI OCX are network connection errors and network read/write errors.

The exact errors that may occur at a site are unknown, but the most probable are listed below:

- 2 : The system cannot find the file specified
- 3 : The system cannot find the path specified
- 4 : The system cannot open the file
- 5 : Access is denied
- 8 : Not enough storage is available to process this command
- 12 : The access code is invalid
- 14 : Not enough storage is available to complete this operation
- 15 : The system cannot find the drive specified
- 19 : The media is write protected
- 20 : The system cannot find the device specified
- 21 : The device is not ready
- 25 : The drive cannot locate a specific area or track on the disk
- 26 : The specified disk or diskette cannot be accessed
- 29 : The system cannot write to the specified device
- 30 : The system cannot read from the specified device
- 31 : A device attached to the system is not functioning
- 32 : The process cannot access the file because it is being used by another process
- 33 : The process cannot access the file because another process has locked a portion of the file

- 36 : Too many files opened for sharing
- 39 : The disk is full
- 51 : Windows cannot find the network path. Verify that the network path is correct and the destination computer is not busy or turned off. If Windows still cannot find the network path, contact your network administrator
- 52 : You were not connected because a duplicate name exists on the network. Go to System in Control Panel to change the computer name and try again
- 53 : The network path was not found
- 54 : The network is busy
- 57 : A network adapter hardware error occurred
- 59 : An unexpected network error occurred
- 64 : The specified network name is no longer available
- 65 : Network access is denied
- 67 : The network name cannot be found
- 70 : The remote server has been paused or is in the process of being started
- 71 : No more connections can be made to this remote computer at this time because there are already as many connections as the computer can accept
- 80 : The file exists
- 82 : The directory or file cannot be created
- 86 : The specified network password is not correct
- 88 : A write fault occurred on the network
- 89 : The system cannot start another process at this time Import API : System Error Codes

A.2.2 Queue Processor Application Error Messages

Startup

Message	Explanation	Action
---------	-------------	--------

Message	Explanation	Action
0^Accusoft Control creation error : < error message >	The Import API uses the AccuSoft Image Gear Toolkit to create the watermarked image. If an error occurs during the creation of AccuSoft controls, the error message displays describing the error.	The AccuSoft controls are installed during MAG*3.0*121 installation. If this error message occurs, contact the VistA Imaging system manager. You may need to reinstall MAG*3.0*121 to correct AccuSoft ImageGear problems.
0^Image is missing from input data.	The image to be watermarked is not in the Import Queue Data.	Check the IMAGE file (#2005) to see if the data is corrupt.
0^Watermark failure : <error message>	The process of burning the “Rescinded” watermark onto the image file failed.	The AccuSoft ToolKit could not create the watermarked image. Check if the rescinded bitmap exists in the image directory C:\Program Files\vista\Imaging\Bmp\MagRescinded.bmp . You may need to reinstall MAG*3.0*121 to correct AccuSoft ImageGear problems.
Create Process failed'+ProgramName	A system error occurred starting the process	Log a Remedy ticket
Increment queue_name Ptr^Failed	The QUEUE POINTER (#1) in the IMAGE BACKGROUND QUEUE POINTER file (#2006.031) in VistA could not be updated	On the main BP window, use the Edit Refresh Queue Counts to correct the current counts. Close the BP and restart the application.

Message	Explanation	Action
Initialization Failure^Log Files at: C:\Program Files\Vista\Imaging\BackprocLog\BackProc\BPError.log	Log file could not be created	Check permissions on the log folder
RAID groups not properly configured Use the Network Location Manager to reset your RAID groups	An active RAID Group has no online shares	Make sure online RAID Group has online shares
Requeue Failure trying to Requeue:	An attempt to re-queue a failed queue entry failed	Use the Queue Manager and step past the queue entry. Determine the problem with the entry that would not re-queue.
SetTime Handle – Destin: C:\Program Files\Vista\Imaging\BackprocLog\BackProc\BPError.log Access is Denied	Could not write the Access Date on the log file	Check the file permissions on the log folder listed.
The Background Processor client software is version <i>n.n.n.n</i> . VistA Imaging Host system has version <i>m</i> installed. Please update to compatible client and host software. Shutting down the Background Processor...	The client software that is installed does not match the KIDS version installed on VistA.	Install the correction version of the KIDS and client software.
The Patch 39 KIDS install on the VistA host system is required for this Version of the: <i>site name</i> BP Queue Processor	The KIDS file for this most recent patch has not been installed in VistA.	Install the KIDS file on VistA.
The Site parameter context could not be determined. The application will terminate.	The PLACE global is corrupt	Log a Remedy ticket

Message	Explanation	Action
This server is not yet configured for BP queue task processing!	There is no BP Server name assigned to this server	Create a BP Server through the GUI and assign tasks to it.

Runtime

Message	Explanation	Action
An Abstract for this file is on the Jukebox, a JBTOHD is being queued	ABSTRACT - The abstract pointer on the RAID is empty. The abstract will be copied from the jukebox	None
Could not complete	DELETE - file could not be deleted	Check permissions on RAID share
Could not complete/Requeued	DELETE - file could not be deleted	Check permissions on RAID share
Current RAID Shares^Exception: No RAID group Assigned	The RAID share must be assigned to a RAID Group	On the BP main window, use Edit Network Location Manager to assign the RAID share(s) to a RAID Group.
False Positive Copy <i>filename(Source), filenames source filesize, filesize(jukebox)</i>	File sizes on source and destination don't match. File not copied.	Determine if images are for different patients
File copied was of size zero	IMPORT - The file size is zero	Resend image from import source
File of size zero created then deleted	MAKEABS - file of zero length was created by Mag_MakeAbs.exe. It was deleted.	Log a Remedy ticket
File was not found	IMPORT - file does not exist on the image share	Resend image from import source
<i>filename</i> Source file does not exist.	Could not find source file	Run Verifier to correct Vista pointers

Message	Explanation	Action
<i>fileshare</i> : Cannot connect to the Export Share.	EXPORT - Cannot map to the remote share	Check for network connectivity. Check permissions..
ForceDirectories failed:	DELETE - could not create directory on jukebox share	Check permissions on jukebox share
Image File type: <i>filename.ext</i> is an Unsupported Format	ABSTRACT - The Full file is not a supported Imaging file type. So the abstract cannot be created.	Examine the "foreign" file and determine if the extension was misnamed.
Jukebox is not available: <i>filepath Volume label</i>	JUKEBOX - the jukebox share is not available	Ping the jukebox server. Check the jukebox share permissions.
Jukebox sourcefile unavailable	JBTOHD - There is no abstract file on the jukebox. The abstract pointer in VistA is not set.	None
JUKEBOX: <i>queue _pointer ^file_extension</i> Not copied	JUKEBOX - Alternate file extension (i.e. .TXT) was not copied	Check file permissions
Login Message^Pausing 3 minutes and will then retry	AUTOLOGIN - could not relog into the Broker	Check for network connectivity.
Login Message^Silent Login attempt failed!	AUTOLOGIN - could not relog into the Broker	Check for network connectivity.
Make AbstractError / abs is already present	ABSTRACT- file already exists at the RAID location specified in VistA	None
Make AbstractError / <i>filename</i>	MAKEABS- the Mag_MakeAbs.exe could not create the abstract file	Log a Remedy ticket
NetConError Using User credentials <i>WIN32_Error</i>	GCC - Could not logon to the remote location with the Username/Password in VistA	Correct the Username/Password for the GCC location in VistA

Message	Explanation	Action
NetConError,"There is no password associated with this Network Location: <i>share_name</i>	GCC - The password field is empty for this Network Location	Enter a password for this GCC location
No Image file entry was created!	IMPORT - an IEN was not created in the image file	Resend image from import source
No Jukebox sourcefile available / Attempting Abstract Queue	JBTOHD - There is no abstract file on the jukebox. The abstract pointer in VistA is set. The Queue Processor will attempt to make on from the Full or BIG file.	None
No Tracking ID IMPORT failed	IMPORT - unique Tracking ID parameter is missing from IMPORT	Resend image from import source
No valid RAID share found	IMPORT - no RAID pointer is set in VistA for the image	Resend image from import source
Problem renaming log file: <i>filename</i>	Could not rename log file to a versioned copy	Check permissions on the existing folder/files
<i>queue_pointer</i> ^Size Mismatch <i>queue_type</i> copy not overwritten.	File sizes on source and destination don't match. File not copied.	Determine if images are for different patients
SetFileTime Failed	Could not set Access date on the log file.	None
The jukebox copy: <i>filename</i> does not exist -- attempting a copy...	DELETE -Could not find the file on jukebox shares. Try to copy from RAID shares to jukebox	None
The RAID share is not on-line	IMPORT - The Image share is not available	Check the permissions on the image share indicated
The <i>src_filename</i> to <i>dest_filename</i> copy failed.	EXPORT - file could not be copied	Check for network connectivity. Check permissions.

Message	Explanation	Action
The VistA cache file: <i>filename</i> not found	DELETE -Could not find the file on RAID shares to delete	None
This Server is not yet configured!	A BP Server has not been associated with this server.	Create a BP Server for this processor
Unable to copy to the Jukebox: Not enough write cache available	JUKEBOX - The jukebox share is not available or is full	Add new platters to the jukebox. Determine why the jukebox share is full. Possibly add new platters to the jukebox.
Zero size <i>queue_type</i> copy NOT overwritten	Zero size file on the destination could not be overwritten	Remove zero size file

A.2.3 Verifier Application Error Messages

Start/Run

Message	Explanation	Action
About to exit without processing: 0	There are no IEN records within the range.	Choose another IEN range
Broker Connection to server could not be established!	VistA RPC Broker is not currently in a listening state OR the application has timed out.	Close the application and restart. Check with the VistA system manager for the status of the Broker listener.
CC:createcontext ("MAG WINDOWS") could not be established!	The user does not have the MAG WINDOWS menu option assigned.	Assign the user this menu option.
lbCacheShare.items.Count < 1: MAGQ SHARES	There are no online, non-router VMC shares.	Use the Queue Processor's Network Location Manager to check/add the shares.
Invalid Input Range	The From and To values entered in the Range are not correct (e.g. Start: 0 End: 0).	Enter a valid <i>From</i> and <i>To</i> range.
jukebox shares are not setup	The jukebox share(s) are offline or don't exist in the NETWORK LOCATION file (#2005.2).	Create/Edit the jukebox shares in the Network Location Manager on the Queue Processor.

Message	Explanation	Action
This workstation is not currently setup as a Background Processor.	There is no BP Server set up for this machine.	Use the option <i>BP Servers</i> on the Queue Processor to register this server.
Verifier client software is version nnn. VistA Imaging Host software is version mmm. Please update to compatible client and host software. Shutting down Verifier...	The version of the KIDS file installed on VistA does not match the executable version on the workstation.	Install the latest KIDS and client software.
VistA shares are not setup	The image share(s) are offline or don't exist in the NETWORK LOCATION file (#2005.2).	Create/Edit the shares in the Network Location Manager on the Queue Processor.

Output HTML Messages

Message	Explanation	Action
Aggregate JB Copy Error:	Could not copy from alternate jukebox to current jukebox	Check permissions
Abs to JB:	Abstract has been created and copied to the jukebox	None
Aggregate Function - Enabled	Software is enabled to copy files from secondary jukebox, if necessary	None
BIG Aggregate Failed	Could not copy BIG file from secondary jukebox	Check file existence/permissions
Create Process failed	Could not create process on VistA for Verifier	Check Error Trap
Empty FBIG node	"FBIG" node has no pointers set in 2005 record.	Check shares for existence of BIG file. If not found, restore BIG file from backup tapes.
File of size zero created then deleted	Abstract file created of size zero. Then it is deleted. (Likely corruption of BIG and/or TGA file)	None
FULL Aggregate Failed	Could not copy FULL file from secondary jukebox	Check file existence/permissions
FULL Aggregate Failed	Could not copy FULL file from secondary jukebox	Check file existence/permissions

Message	Explanation	Action
Images JB share is OFF-LINE:	jukebox is offline	Set jukebox back ONLINE
Make AbstractError	Abstract file could not be created from TGA/BIG (BIG/TGA not found or image file corruption).	Check shares for existence of BIG/TGA file. If not found, restore BIG/TGA file from backup tapes.
New Abs to CWL	An abstract file has been created and copied to the current write image share	None
No ABS file VC Ptr Cleared	Abstract file not found on the Image share	None
No ABS file VC Share OFF-Line	Image share is offline at location of abstract file	Set share back online and re-run Verifier
No ABS JB Files	No abstract file found on the jukebox	Check shares for existence of ABS file. If not found, restore ABS file from backup tapes
No Acquisition Site in Image file	The ACQUISITION SITE field #100 in the IMAGE file (#2005) is missing. This is a required field.	Contact IRM Update the field with the proper site ID.
No FULL JB Files	FULL file not found on the jukebox	Check shares for existence of Full file. If not found, restore Full file from backup tapes
No FULL VC Files	FULL file not found on the Image share	None
No jukebox BIG Files	BIG file not found on the jukebox	Check shares for existence of BIG file. If not found, restore BIG file from backup tapes.
No jukebox FULL Files	FULL file not found on the jukebox	Check shares for existence of Full file. If not found, restore Full file from backup tapes.
No Network References	No IMAGE file (#2005) record exists for this image	Re-import image thru the Capture client
No Network References: Archived Image	Image has been archived, resides in the IMAGE AUDIT file (#2005.1)	None
No VC BIG Files	Could not find the BIG file on the image share	None
Not Certed	Could not find/create file type on jukebox	Check shares for existence of BIG file. If not found, restore BIG file from backup tapes.

Message	Explanation	Action
Problem rename log file:	Permission problem with log file	Set WRITE permissions set on share/folder/file for Windows login account.
Text file Patient ID not in VistA	Could not locate patient ID in VistA	Contact IRM
TXT to BIG VC	Copy TXT file to same share as BIG file	None
TXT to FULL VC	Copy TXT file to same share as FULL file	None
"Check Text" Option Messages		
Text File Corruption Error Type 1:	Text file is binary or unreadable	Restore file from jukebox/backup tapes
Cannot determine Text file type:	Foreign text file was not likely generated on the image gateway	Restore file from jukebox/backup tapes
Text File Corruption Error Type 2:	Text file is ASCII but has unprintable characters or truncated	Restore file from jukebox/backup tapes
Text/Image DFN Mismatch:	Patient ID in text file does not match that in VistA	Future utility patch
Text/Image SOP/UID Mismatch	The Series Instance UID in the text file does not match the one in VistA	Future utility patch
Text/Image Study/UID Mismatch	The Study Instance UID in the text file does not match the one in VistA	Future utility patch
Text/Image UID Mismatch	SOP and/or Study UID are/is blank in text file	Future utility patch
Updated Text file	Text file has been edited	Validate file has been copied to the jukebox
No SSN Found	Patient ID field missing in text file	Future utility patch

Integrity Messages on Patient Data

There are integrity issues that will prevent their respective images from being displayed and others that will not impact the viewing. See Appendix C in the *Background Processor User Manual* for sample output.

Conditions Preventing Viewing

An integrity error message will be generated when the image is retrieved for viewing on these conditions and the patient image will not be viewable until the condition is corrected or the user has the proper key to view these images.

Message	Explanation	Action
No Image Ptr in AP	The Clinical Association Report (AP for this image does not contain an image entry that points back to this image.	Future utility patch
GP has no images	Image series that does not contain any images. Group Parents (GP) are containers for an Image series. A group parent with NO group objects (GO) is an invalid condition.	Future utility patch
Conflicting AP & Image DFNs	The patient file reference (DFN) in the Clinical Association Report (AP does not match the DFN in the IMAGE file (#2005).	Future utility patch
Invalid Image Ptr to AP	The Clinical Association Report (AP) has image references that are not in the IMAGE file (#2005).	Future utility patch
Conflicting GP and GO DFN	The patient file reference (DFN) in the Group Parent (GP) is not the same as the DFN in the Image entry.	Future utility patch
GP & GO AP Mismatch	The Group Parent and Group Object pointer references to a Clinical Association Report (AP) do not match.	Future utility patch
GP Missing GO Ptr	The Group Object multiple of the referenced Group Parent does not reference this group object.	Future utility patch

Message	Explanation	Action
No AP Mult Ptr	This Image entry does not have the clinical application (AP) image multiple entry number specified. The IMAGE file (#2005).record is missing the <i>PARENT DATA FILE IMAGE POINTER</i> (#17) for a Clinical Association Report (AP).	Future utility patch
GO DFN mismatches	Some image file Group Objects have different PATIENT references (DFN).	Future utility patch
Image entry is structurally abnormal	The normal structure that distinguishes Image entry Group Parents (GP), Group Objects (GO), and Non-Group image (NG) is corrupt.	Future utility patch
Missing Group Objects	The Group Parent has Group Object references that are missing.	Future utility patch
DFN Mismatches in AP Image Mult	The Clinical Association Report (AP) references a Group Parent that has image files with a different PATIENT reference (DFN) than the report.	Future utility patch

Conditions Allowing Viewing

The following integrity issues will **not** prevent their respective images from being displayed. These are informational messages.

Message	Explanation	Action
No AP Ptr	The IMAGE file (#2005) record is missing the PARENT DATA FILE# (#16) for a Clinical Association Report (AP). This Image does not have the entry in the clinical application (AP) specified.	Future utility patch
No AP entry Ptr	This Image does not have the entry in the clinical application (AP) specified. The IMAGE file (#2005) record is missing the <i>PARENT GLOBAL ROOT DO</i> (#17) for a Clinical Association Report (AP).	Future utility patch

A.2.4 Purge Application Error Messages

Message	Explanation	Action
Broker Reconnection failed	Auto login after a Broker disconnect failed	Check network. Contact IRM
Create Process failed <i>ProgramName</i> ,	Windows failed to create a process.	Reboot the server.
Express Purge Rate limit reached: <i>PurgeRate</i> on share: <i>CurrentShare</i>	The purge terminated on the given share because Express Purge was active and the Purge process exceeded the user defined purge rate.	None
File Delete failure: <i>filename</i>	The file listed could not be deleted.	Check permissions on the share/folder/file
File in use: <i>filename</i>	The log file is in use	Exit from the Purge and restart

Message	Explanation	Action
File purged: <i>filename</i> . 'The Image file (#2005) was not updated'	The file was deleted on the RAID, but the pointer in VistA could not be updated.	Validate the IEN record exists in VistA.
Findfirst failed <i>filename</i>	The directory traversal failed	Exit from the Purge and restart
Log File Archival reset to: <i>FilePath2</i> instead of: <i>FilePath1</i>	The logs files are now being stored at another location.	None
Login Message^Broker Reconnection Successful	After a Broker disconnect, the application was able to reconnect to VistA.	None
Login Message^Pausing 3 minutes and will then retry	After a Broker disconnect, the application tries 3 times to reconnect to VistA	None
Login Message^Silent Login attempt failed!	After a Broker disconnect, the application was not able to reconnect to VistA.	Check network connections.
NewCreationDate^SetFile Time Failed <i>filename</i>	Could not set the date of last Accesses on filename	None
Non-Connection related Broker error	Broker disconnected	Check VistA for error trap
NOT Purged criteria: <i>EvalCriteria</i> NOT PURGED-JUKEBOX QUEUED <i>filename date</i>	File was not deleted. See Section 6.4 Purge Criteria.	None
Problem renaming log file <i>filename1</i> -> <i>filename2</i>	Could not rename log file to versioned log file name	Check permissions.
Purge Criteria: <i>EvalCriteria filename filedate</i>	See Section 6.4 Purge Criteria	None
Purge Criteria: <i>EvalCriteria</i> NOT PURGED <i>filename filedate</i>	File was deleted. See Section 6.4 Purge Criteria	None

Message	Explanation	Action
Silent Login attempt	Broker was disconnected. Auto login is initiated.	None
Start Date failure	Problem with Date of Last Purge on Scheduled Purge	Contact IRM to clear the record in the Imaging Site Parameter file.

A.3 DICOM Gateway Error Messages

Information about DICOM Gateway Error messages is available in the *VistA Imaging Error Message Guide*.

A.4 Clinical Display/Capture Setup Error Messages

The following errors are possible during the MAGINSTALL.EXE file execution. When the MAGINSTALL file is transported via FTP, it should be in binary format (or possible file corruption may occur).

Error Message	Notes
Incorrect Windows version.	Review the installation manual regarding the application's Windows compatibility.
Invalid executable file.	Possible corrupted MAGINSTALL.EXE file.
Type of executable file was unknown.	Possible corrupted MAGINSTALL.EXE file.
Attempt was made to load a second instance of an executable file containing multiple data segments that were not marked for read-only.	Possible corrupted MAGINSTALL.EXE file.
Dynamic Link Library (DLL) file was invalid.	One of the DLLs required to run this application was corrupt.
[2] Imaging Display	The Imaging Display application is open. Close the application and click retry.
[1] Imaging Capture	The Imaging Capture application is open. Close the application and click retry.

A.5 VistARad Error Messages

Error messages associated with the VistARad application are listed below. Messages are listed alphabetically. This list is not exhaustive. It omits some messages which are informational,

supply their own remediation instruction, or are otherwise self-evident. If a message not on this list appears and requires further explanation, please contact the National Help Desk.

Error Message	Cause(s)/Solutions
Case #nnn is already locked by you, perhaps at another workstation.	A user has attempted to lock an exam that is already locked in their name. This could occur from two different logons from different workstations; or, it could result from a failed connection that left a process hanging without a connected client.
Case %s: all images failed to load.	No images for the selected case could be found. If any valid headers are located, one or more “dummy” thumbnails may be displayed in the Preview window, but no actual images are available. Close the exam, then attempt to re-open it. If the problem persists, contact the local Imaging Coordinator.
Case #nnn is Locked by [Name/Unknown]; Status Update will NOT be allowed.	Between the time that the exam was opened and locked, and the time the exam was closed for update, the Exam lock information had changed, making the exam not updateable. If this occurs, check for problems in the lock table or with the Broker connection.
Case #nnn locked by [name], not locked by [user]--No Status update performed	Between the time that the exam was opened and locked, and the time the exam was closed for update, the lock information either was killed, or over-written with another user’s information.
Case #nnn was previously locked by [Radiologist]. The lock is now assigned to you.	The radiologist that previously had the lock likely had the M session abnormally terminated.
Case %s: no valid headers found.	Images in the exam do not have valid headers and cannot be processed properly. The exam load is considered successful. You can display images by loading the “IMG_INVALID_TEXT” stack in the Preview window into the Viewer; the exam can be locked for interpretation.

Error Message	Cause(s)/Solutions
Case %s: some image(s) are missing.	<p>Some images and/or headers could not be found. The exam load is considered incomplete. Depending on what is missing, one or more placeholders will be used in the Preview and Viewer windows. The exam cannot be locked or interpreted.</p> <p>Close the exam, then attempt to re-open it. If the problem persists, contact the local Imaging Coordinator.</p>
Case %s: some image(s) have invalid or missing headers.	<p>The headers for some images in the case could not be found. Images that can be processed properly will be displayed normally; images that could not be processed due to missing header data will be loaded into the Preview window only with an “IMG_INVALID_TEXT” label.</p> <p>The exam can be locked and interpreted.</p>
Case with number xxx will not be loaded, Error 0x %x.	<p>A VistARad internal error occurred while opening the exam.</p>
Could not send files to MIRC Server at <Host Name> and Port <Port Number> with AE Title <AE Title>.	<p>Ensure that the MIRC server configuration information is correct, that the MIRC server is online, and that it can receive messages.</p>
Current Case Not Accessible for Updating	<p>A user request to close an exam cannot be processed because the data does not have valid information that correctly identifies a Radiology study. Check the exam data stored in the Radiology database.</p>
Current Case not accessible to close--no action taken	<p>A user request to close an exam cannot be processed because the data does not have valid information for the Radiology study. Check the exam data stored in the Radiology database.</p>
Don't know how to read this image element.	<p>An unexpected value was found in the last DICOM tag listed in the Viewport Info tab of the Hanging Protocol Definition dialog. The hanging protocol definition cannot be saved. Verify that the image header is populated properly for the DICOM tag in question.</p>

Error Message	Cause(s)/Solutions
Error getting shared CPT-HP association info.	VistARad was unable to read information from the VistA host. Check the VistA error trap & contact your Imaging Coordinator or the National Help Desk.
Error Initializing HP module.	VistARad was unable to read information from the VistA host. Check the VistA error trap & contact your Imaging Coordinator or the National Help Desk.
Error occurred while performing search.	The VistARad client was not able to contact the VistARad host. Check for status details at the bottom of the manager window.
Error Reading File MAGJ.ini	MAGJ.ini not present in expected location (C:\Program Files\Vista\Imaging\MAG_VistARad). The software will start, but users will not be able to display local copies of routed exams or use integrated voice dictation functions until the problem is resolved.
Error reading settings. VistARad will exit.	The client was unable to retrieve monitor information from the VistARad back end on the VistA Host. Verify that the VistA Host is accessible and running.
Error retrieving monitor information (Error:%d). VistARad will exit.	The VistARad client could not retrieve monitor information stored on the VistARad back end. System queried back end for monitor information but gets no response. Verify that a connection is present and that the VistA system is up and running.
Exam is for Station (nnn); you are logged on to #mmm". Exam is NOT Locked.	The exam being opened is exam registered at a consolidated site that is a not the user's logon site (division). The exam can be displayed but its status cannot be updated.
Exam Manager failed to Initialize. VistARad will exit.	The client was unable contact VistARad back end on the VistA Host. Verify that the VistA Host is accessible and running, and that the correct KIDS version is installed.

Error Message	Cause(s)/Solutions
Exam Status for Case #nnn CANNOT be updated; current status remains: [Status]	<p>The status update cannot proceed because there is insufficient information in the radiology record to allow the status to advance.</p> <p>If this occurs frequently, then the site has not properly performed VistARad system setup regarding Radiology Exam Status codes definition—refer to Chapter 3 in the <i>Vista Imaging Installation Guide</i>.</p>
Failed to get HP info from the backend for default system user. Error code 0x80004005.	VistARad was unable to read information from the VistA host. Check the VistA error trap & contact your Imaging Coordinator or the National Help Desk.
Failed to import user profile. Click OK to exit VistARad.	VistARad was unable to read information from the VistA host. Check the VistA error trap & contact your Imaging Coordinator or the National Help Desk.
Failed to read in xxx preset definition of the current or system user correctly.	There was a problem processing the specified image preset definition. Do not use the specified image preset until the problem is resolved.
Failed to read in xxx template definition of the current or system user correctly.	There was a problem processing the specified template definition. Do not use the specified template until the problem is resolved.
Failed to retrieve a preset xxx for user xxx	There was a problem retrieving preset information from the VistARad back end. Verify that a connection is present and that the VistA system is up and running.
For Case #nnn, current Status is [status]; Stats Update will NOT be allowed	Between the time the exam list indicated an exam was lockable and the time the exam was opened, the exam status had changed, making the exam not lockable. If this happens frequently, exam list compile intervals specified in the MAG VISTARAD SITE PARAMETERS file (#2006.69) may need to be adjusted.
For MAGJ STUDYDATA (TX="_TXID_") invalid params passed to rpc call.	Invalid request for key image and/or presentation state data was received on the VistA host; could indicate a database problem with the exam or images in the exam being looked at.

Error Message	Cause(s)/Solutions
HP creation failed, error code xxxx	An application error prevented creation of the hanging protocol; record the error code and contact Customer Support.
HP named xxx could not be read in correctly.	There was a problem processing the specified hanging protocol definition. Do not use the specified hanging protocol until the problem is resolved.
Insufficient memory; cannot load all text files, thumbnails and/or key images. Load aborted for case(s) XXX.	Exit and restart VistARad to clear any potential memory issues. Attempt to reload the exam in question. Contact your Imaging Coordinator if the error persists.
Invalid Request (ListType=xxx)	An attempt to compile an exam list failed. The exam list definition in MAG RAD LISTS DEFINITION file (#2006.631) may be corrupted. The exam list definition should be fixed or disabled.
Invalid transaction (TX="_TXID_") requested by MAGJ STUDYDATA RPC call.	Invalid request for key image and/or presentation state data was received on the VistA host; could indicate a database problem with the exam or images in the exam being looked at.
Modality type xxx not found in the configuration file.	hpconfig.xml does not contain information for the modality associated with the active exam. Verify that modality for the exam in question is being correctly identified and that hpconfig.xml file stored in the VistARad application folder is present and not corrupt.
Modality xxx not found. Please contact your system administrator"	The hpconfig.xml file does not contain information for the modality associated with the active exam. Verify that modality for the exam in question is being correctly identified and that hpconfig.xml file stored in the VistARad application folder is present and not corrupt.
No data supplied for History List update/delete.	The client software performed an invalid request to update the History list.
No modality in this stack of images	The exam being opened does not contain modality information.

Error Message	Cause(s)/Solutions
No Update Allowed for Case #nnn--current status is [Status]	Between the time that the exam was opened and locked, and the time the exam was closed for update, the Exam Status information had changed, making the exam not updateable. This can occur if a data entry operation was performed in Radiology package while the exam was being read.
Image loading has been paused: not enough memory to load all images at once. Use the Preview window's List view mode to load and/or purge selected image sets.	Using the Preview window in List View mode, click “Purge” on one or more (partially) loaded series to free their memory. Then click “Resume” on the series of interest that was paused.
Request Contains Invalid Case Pointer (nnn^nnn^nnn^nnn).	A user request to open an exam cannot be processed because the data does not have valid information that correctly identifies a Radiology study. Check the exam data stored in the Radiology database.
Resource limit exceeded! Close some images	The maximum number of DIMPLX controls allowed by the operating system has been exceeded. Use the layout controls in VistARad to reduce the number of visible viewports.
Startup problem: cannot launch background case loader. Startup problem: cannot launch background cleaner. Startup problem: cannot create image load/display objects.	Exit and restart VistARad; contact customer support if this error persists.
The current History List may not be updated by the current user.	The client software performed an invalid request to update the History list.
The Exam file for this exam has patient [Pat1]; the corresponding Report file has patient [Pat2]. This is a serious problem--immediately report it to Radiology management and Imaging support!	The exam failed a “Patient Safety” check.

Error Message	Cause(s)/Solutions
This exam has no report entry for associating images; no images can be accessed.	There is no Radiology Report link for the images in the exam being opened. Could be normal; or, a database problem (e.g., induced by deleting a Report without first correcting images).
This exam has problems in the Radiology files, with two different Case Numbers referenced Ref1 and Ref2. This is a potentially serious problem—immediately report it to Radiology management and Imaging support staff!	The exam failed a “Patient Safety” check.
This exam has problems in the Radiology Report file, with two different report entries referenced Ref1 and Ref2. This is a potentially serious problem--immediately report it to Radiology management and Imaging support staff!	The exam failed a “Patient Safety” check.
This exam is linked to Report entry #nnn, but some of its images may be linked to Report entry #mmm. This is a potentially serious problem--immediately report it to Radiology management and Imaging support staff!	The exam failed a “Patient Safety” check.
This exam is registered for [Pat1]; however, it is linked to images for patient [Pat2]. This is a serious problem--immediately report it to Radiology management and Imaging support staff!	The exam failed a “Patient Safety” check.
The resolution of the display is not suitable for displaying diagnostic quality images. VistARad will exit.	This message appears if monitor resolution width is less than 1024, or if monitor resolution height is less than 700, or if monitor bit depth is less than 8.
Unable to access HISTORY File for deleting records; try again later.	A delete or other update operation cannot be performed because the current M process cannot lock the file for the user.

Error Message	Cause(s)/Solutions
<p>Unable to connect to specified host/port or Unable to obtain VIX connection information for the specified Site code</p>	<p>VistARad cannot establish a connection to the specified remote VIX server. Verify correct data entry. If necessary, consult your local ADPAC to confirm that the specified VIX server is on-line and the Site Service is configured properly.</p>
<p>Unable to get/update user data (USER_name) for MAGJ USER DATA RPC call.</p>	<p>The system could not retrieve data from the MAGJ USER DATA file (#2006.68).</p>
<p>Unable to open device 'IMAGING WORKSTATION'</p>	<p>Attempt to display a VistARad report fails because the host system cannot open the device for host file output. Fix the device file entry.</p>
<p>Unable to retrieve images for Case #nnn</p>	<p>Probably a database problem; the system expected to find images, but did not find any.</p>
<p>Unable to update Interpreting Radiologist:[Explanation provided]</p>	<p>The Status Update cannot proceed because the user fails Radiology package user security checks.</p>
<p>Update failed</p>	<p>There was a problem saving preset information to the VistARad back end. Verify that a connection is present and that the VistA system is up and running.</p>
<p>Updates not allowed at this site--no action taken</p>	<p>After the exam was closed and locked, the back end "Enable Status Update" setting has been disabled.</p>
<p>VistARad cannot run in a terminal services client environment. VistARad will exit.</p>	<p>VistARad cannot be launched using a remote desktop connection or terminal services client.</p>
<p>VistARad is already running. Exiting application.</p>	<p>Another instance of VistARad is running on the workstation. If that instance cannot be accessed from the Windows Taskbar, you may need to kill the process named "VistARad Viewer" using the Windows Task Manager; you may need to end the MAG_Vistarad.exe process from within the Processes tab of the Windows Task Manager. Then re-launch VistARad.</p>

This page intentionally left blank.

Appendix B: Means Tests

B.1 Sending Means Tests to the HEC

The following is the current list of 'Image Types' that need to be sent to the HEC (Health Eligibility Center):

- MEANS TEST (10-10EZ)
- MEANS TEST (10-10EZR)*
- MEANS TEST (10-10F)

* The (HEC) has requested that a third type of Means Test (EZR) be copied to them. Sites need to add the MEANS TEST (10-10EZR) Image Index Type to the IMAGE ACTIONS file (#2005.86) to allow the transfer of this type of Means Test.

- A qualified person at the site needs to use FileMan to edit the IMAGE ACTIONS file (#2005.86); select the TYPE field (#5); and choose HEC COPY at the Image Action name field prompt.
- You can also log a Remedy ticket and have VistA Support guide you through this process.

An example of adding a new Index Type to be sent to HEC is shown below. User entries are shown in **bold**.

```
D P^DI
VA FileMan 22.0

Select OPTION: ENTER OR EDIT FILE ENTRIES

INPUT TO WHAT FILE: IMAGE ACTIONS
EDIT WHICH FIELD: ALL// TYPE (multiple)
EDIT WHICH TYPE SUB-FIELD: ALL// <ENTER>
THEN EDIT FIELD: <ENTER>

Select IMAGE ACTIONS NAME: HEC_COPY
Select TYPE: MEANS TEST (10-10F)// ? <ENTER> or type two question marks and press <ENTER>
Answer with TYPE
Choose from:
MEANS TEST (10-10EZ)
MEANS TEST (10-10F)
    You may enter a new TYPE, if you wish
Answer with IMAGE INDEX FOR TYPES NAME, or CLASS
Do you want the entire 57-Entry IMAGE INDEX FOR TYPES List? Yes <ENTER>

Choose from:
List has been shortened for this example

ADVANCE DIRECTIVE
BILLS
COMMITMENT
DD214 ENLISTED RECORD & RPT OF SEP
ELIGIBILITY/VA FORM 10-7131
FINANCIAL WORKSHEET
HEALTH INSURANCE CARDS
IMAGE
LEGAL DOCUMENTS
```

Appendix B – Means Tests

```
MEANS TEST (10-10EC)
MEANS TEST (10-10EZ)
MEANS TEST (10-10EZR)
MEANS TEST (10-10F)
MEDICAL CERTIFICATE

Select TYPE: MEANS TEST (10-10F)// MEANS TEST
  1 MEANS TEST (10-10EZ)
  2 MEANS TEST (10-10F)
CHOOSE 1-2: <ENTER>
  1 MEANS TEST (10-10EC)
  2 MEANS TEST (10-10EZ)
  3 MEANS TEST (10-10EZR)
  4 MEANS TEST (10-10F)
CHOOSE 1-4: 3 MEANS TEST (10-10EZR)
Are you adding 'MEANS TEST (10-10EZR)' as a new TYPE (the 3RD for this IMAGE ACTIONS)? No//
Yes
Select TYPE: <ENTER>

Select IMAGE ACTIONS NAME: <ENTER>

To check the new file entry:

Select OPTION: INQUIRE TO FILE ENTRIES

OUTPUT FROM WHAT FILE: IMAGE ACTIONS// <ENTER>
Select IMAGE ACTIONS NAME: HEC COPY
ANOTHER ONE: <ENTER>
STANDARD CAPTIONED OUTPUT? Yes// <ENTER>
Include COMPUTED fields: (N/Y/R/B): NO// <ENTER>
- No record number (IEN), no Computed Fields

NAME: HEC COPY          ACTIVE: NO
TAG: HEC                ROUTINE: MAGGSPP
DESC: Means Test document images will be copied to the Health Eligibility Center (HEC)
TYPE: MEANS TEST (10-10EZ)
TYPE: MEANS TEST (10-10F)
TYPE: MEANS TEST (10-10EZR)

Select IMAGE ACTIONS NAME: <ENTER>
```

Note: Sites would only want to add/expand on what gets sent to the Health Eligibility Center (HEC) upon a direct request from the Health Eligibility Center (HEC) to do so. This is usually a rare occurrence, and all sites will be notified if this occurs.

This page intentionally left blank.

Glossary

AE_Title	The unique name assigned to a DICOM application to identify the application to other DICOM applications on the network. AE_Title will be used to log machine-to-machine communication within this patch.
CD	Compact Disc
cPACS	Commercial PACS
DICOM Correct	The name assigned to the software routine used to correct DICOM Objects that fail processing on the DICOM Gateway.
DICOM Gateway	Interface between VistA and external DICOM application entities. See <i>VistA Imaging DICOM Gateway</i> .
DICOM Importer II	Refers to the software that performs the automated DICOM import process from outside facilities.
DICOMDIR	A file that is a unique and mandatory DICOM Directory file that contains the Media Storage Directory SOP Class as described in DICOM PS 3.10 2008.
DoD	Department of Defense
DUZ	The internal entry number of a VistA user's entry in the NEW PERSON file (#200).
DVD	Digital Versatile Disc
GUI	Graphical User Interface
HDIG	Hybrid DICOM Image Gateway: An image gateway that combines the legacy DICOM Gateway and the new VISA Gateway. It implements DICOM services.
HIPAA	Health Insurance Portability and Accountability Act
IA	Integration Agreement
IHE	Integrating the Healthcare Enterprise
IHS	Indian Health Services
KIDS	Kernel Installation and Distribution System

PACS	Picture Archiving and Communications System
Partial Study	A study where only a subset of the available images have been staged or imported.
PHI	Protected health information: Individually identifiable health information transmitted by electronic media, maintained in electronic media, or transmitted or maintained in any other form or medium.
RPC	Remote Procedure Call
SCP	Service Class Provider
SCU	Service Class User
SOP	Service Object Pair
SOP Class	Unique identifier assigned by the DICOM Standard to identify DICOM objects.
Staging	<p>Copying study data from either media or an authorized network location into temporary persistent storage for later reconciliation. There are two types of staging (controlled by Security Keys):</p> <p>Basic Staging: An authorized user copies all study data from an authorized source to Importer II Persistent Storage.</p> <p>Advanced Staging: An authorized user can view source data by study and copy data by study to Importer II Persistent Storage.</p>
Storage media	The physical device onto which data is recorded.
Supported SOP Class	A DICOM Object that can be processed by the DICOM Gateway and delivered to other VistA Imaging applications for use within VistA Imaging.
TWAIN	An interface standard for scanners, cameras and other input devices. A TWAIN driver is generally supplied by the equipment vendor.
UID	DICOM unique identifier
VA	US Department of Veterans Affairs
VISA	VistA Imaging Services Architecture
VISN	Veterans Integrated Service Network
VIX	VistA Imaging eXchange – Software platform for managing site service and other VISA services.

Index

%
% Server Reserve, 123

A
ad hoc reporting, 157
ADPAC staff requirements, 29
ADT protocols, 171
archiving, 97
Auto-Write function, 123

B
Background Processor
 configuration guidelines, 104
 files installed on, 50
 overview, 5
BackProc.log file, 101, 102
backward compatibility, 169
biomedical staff requirements, 29

C
CCOW, iv, v, 2, 144, 145, 146
Check text files, 122
Clinical Workstation
 files installed on, 42
CONFIGURE IHE-BASED HL7 ADT
 INTERFACE TO PACS menu option, 87
Context Management, iv, 2, 145, 146
CPRS, iv, 2, 144, 145, 146, 147, 155, 189

D
DFNError log file, 103
DICOM error log, 131
DICOM Gateway, 125
 and PACS, 169
 HL7 messages and, 143
DICOM overview, 2
DICOM_Echo, 28
document counts report, 157
drag, 11

E
error log
 DICOM, 131
 MSM, 131
Error messages, 214
event viewer, 28, 30
exported options, 85

F
failed images, processing, 130
file migration, 126
file security, 79
FileMan files, 63

G
global journaling, 83

H
hardware maintenance, 21
HEC, sending means tests to, 223
HL7 application parameters, 143
HL7 logical link, 143
HL7 MESSAGE TEXT file (#772), 181
HL7 messages, 143
HL7 protocols
 Radiology v.2.1, 169
 Radiology v.2.4, 170

I
ICRs (integration control registrations), 144
Image Cache, 147
image count by user report, 158
IMAGE file (#2005)
 deletion, 98
 migration, 97
IMAGE file (#2005)
 archiving or purging, 97
images
 taking offline, 126
 viewing remotely, 185

IMAGING HL7 MESSAGING

MAINTENANCE, 85

Imaging package requirements, 13

Imaging Site parameters, 115

Imaging system

general maintenance, 29

overview, 1

RPC calls, 144

Import API, 134

input templates, 72

Integration Agreement, 144, 225

Integration Agreements, 144

Internal Relations, 169

IRM staff requirements, 28

J

journaling, 83

jukebox backups, 125

K

Kernel, 2, 13, 14, 41, 94, 137, 138, 185, 189

KIDS, 28, 36, 95, 126, 152, 155, 202, 203,
207, 217**L**

Log files

Background Processor, 100

BackProc.log, 101, 102

DFNError log, 103

NoArchive log, 102

Purge.html log, 103

PurgeError.html log, 103

Queue Processor, 101

Scan log, 102

ScanError log, 103

Verifier log files, 102

M

MAG CLIENT VERSION REPORT menu

option, 92

MAG CPACS, 143

MAG HL7 MAINT menu option, 85

MAG REASON EDIT menu option, iv, 90

MAG SERVER mail group, 147, 148

MAG_Decompressor, 60

MAGD MAINT RAD HL7 SUBS menu

option, 86

MAGREPSTART, 156

MailMan messages, 147

MAINTAIN SUBSCRIPTIONS TO

RADIOLOGY HL7 DRIVERS menu

option, 86

maintenance

general, 29

hardware, 21

security software, 25

means test report, 161

means tests, 223

Menus

Imaging System Manager, 85

VistARad System Options, 93

messages

HL7, 143

Image Cache, 147

MailMan, 147

site usage, 148

Windows, 144

Microsoft patches, installing, 21

modalities, changes to, 21

mouse, 10

MSM error log, 131

N

Network Location Manager, using, 113

network resources, 27

NoArchive log file, 102

O

offline images, 126

online help, 179

P

package index contains 'note' report, 162

package requirements, 13

package-wide variables, 177

patches, Microsoft, installing, 21

patient movement protocol, 174

PII, 2

ping, 28

power requirements, 28

processing failed images, 130

productivity reports, 157
protocols
 patient movement, 174
 radiology, 169, 173
Purge configuration, 108
Purge log files, 103
Purge.html log file, 103
PurgeError.html log file, 103
purging, 97, 98
 image shares, 128
 message files, 130
 modality worklist, 130
 PACS messages, 130

Q

Queue Processor overview, 5

R

Radiology HL7 v2.1 protocols, 169
Radiology HL7 v2.4 protocols, 170
radiology protocols
 DICOM, 169
 VistARad, 173
radiology report transcription service, 181
RAID Group Advance, 123
reboot, 9
remote access requirements, 28
Remote Image Views, 185
reports, imaging site, 157
routines
 non-M, 41
RPC calls
 VistA Imaging, 144

S

Scan log file, 102
ScanError log file, 103
Scheduled Verifier, 121

security, 25
 file, 79
security keys, 15
server manager, 28
site parameters for Imaging, 115
site usage messages, 148
space requirements, 27
staff requirements
 ADPAC, 29
 biomedical, 29
 IRM, 28
system outages, 83

T

TeleReader, 18, 22, 51, 118, 146, 154, 155, 185
TraceRT, 28
Two-Factor Authentication (2FA), 189

U

user manager, 28

V

Verifier overview, 6
Verifier, using, 125
VistA Imaging ADT protocols, 171
VistA Site Service, 14, 166, 186
VIX, 7, 27, 61, 131, 166

W

window controls, 10
Windows 7, iv, 2, 8, 41, 42, 49
Windows messaging, 144
Windows servers, changes to, 21
Workstations, 9