

**InterSystems Health Connect (HC) / Electronic
Contract Management System (eCMS)**

**Deployment, Installation, Back-Out, and Rollback
Guide**



January 2019

Department of Veterans Affairs (VA)

Office of Information and Technology (OIT)

Revision History

Date	Revision	Description	Author
1/16/2018	0.8	Revised section 3 Deployment	Halfaker: KL
12/21/2018	0.7	VA Tech Edit Review: <ul style="list-style-type: none"> • Made style and format updates throughout to continue with same look and feel in other FM24 project documents. • Added alternate text to all images for Section 508 conformance. • Used Track Changes to enter all of my edits and comments. If you accept the changes I'm sure there will be some follow-up formatting issues. It's hard to check/correct formatting when in Track Changes mode. 	VA Tech Writer: TB
12/18/2018	0.6	Revised section 5 Back-Out Procedure	Halfaker: KL
12/12/2018	0.5	Additional feedback after review meeting and approved deployment approach	Halfaker: DR
12/05/2018	0.4	Created an alternative deployment approach	Halfaker: DR
11/07/2018	0.3	Added details for HC settings details and incorporated team feedback	Halfaker: DR
11/01/2018	0.2	Added details for deployment and back-out	Halfaker: DR
10/16/2018	0.1	Created initial outline	Halfaker: DR

Table of Contents

Revision History	ii
List of Figures.....	iv
List of Tables.....	v
1 Introduction	1
1.1 Purpose	1
1.2 Dependencies	1
1.3 Constraints	2
2 Roles and Responsibilities.....	2
3 Deployment	3
3.1 Timeline.....	10
3.2 Site Readiness Assessment.....	11
3.2.1 Deployment Topology (Targeted Architecture).....	11
3.2.2 Site Information (Locations, Deployment Recipients).....	12
3.2.3 Site Preparation	12
3.3 Resources	12
3.3.1 Facility Specifics.....	13
3.3.2 Hardware	13
3.3.3 Software.....	13
3.3.4 Communications.....	13
3.3.4.1 Deployment/Installation/Back-Out Checklist	13
4 Installation.....	14
4.1 Platform Installation and Preparation	14
4.2 Download and Import Files.....	14
4.3 Database Creation	16
4.4 Installation Scripts	16
4.5 Cron Scripts.....	16
4.6 Access Requirements and Skills Needed for the Installation.....	16
4.7 Installation Procedure.....	16
4.8 Installation Verification Procedure	16
4.9 System Configuration	16
4.10 Database Tuning.....	16
5 Back-Out Procedure	17
5.1 Back-Out Strategy	17
5.2 Back-Out Considerations	17
5.2.1 Load Testing	17
5.2.2 User Acceptance Testing.....	17

5.3	Back-Out Criteria	17
5.4	Back-Out Risks	17
5.5	Authority for Back-Out.....	18
5.6	Back-Out Tasks	18
5.6.1	VIE Message Flows.....	18
5.6.2	Health Connect Flows	18
5.6.3	eCMS Connection	18
5.6.4	VistA Sites Repoint to VIE.....	18
5.7	Back-Out Verification Procedure	18
6	Rollback Procedure	19
7	Appendices	20
7.1	Appendix A—Health Connect Production Namespace Configuration and Deployment	20
7.1.1	Creating a New Namespace	20
7.1.2	Deploying a Health Connect Production	20
7.2	Appendix B—Configuring a Health Connect Production.....	22
7.2.1	Configuring Each Regional Health Connect Production.....	22
7.2.2	Configuring Enterprise Health Connect Production.....	25
7.3	Appendix C—Starting and Stopping a Health Connect Production.....	28
7.3.1	Starting Health Connect Production	28
7.3.2	Stopping Health Connect Production	28

List of Figures

Figure 1:	Current VIE Architecture for eCMS	3
Figure 2:	Deploy Health Connect Productions	4
Figure 3:	Disable eCMS Outbound Flows	5
Figure 4:	VistA HL7 Logical Link Screens	6
Figure 5:	VistA Sites Start Redirecting Outbound Messages	8
Figure 6:	eCMS Connects Inbound to HC	9
Figure 7:	eCMS Connection to HC for Outbound	9
Figure 8:	Targeted eCMS Architecture.....	11
Figure 9:	Management Portal (MP)—Deployment Options	14
Figure 10:	SM—Selecting Deployment File: eCMS.....	15
Figure 11:	SM—Deploy Production Changes Screen: eCMS	15

List of Tables

Table 1: Roles and Responsibilities	2
Table 2: Site Preparation.....	12
Table 3: Download and Import Files.....	14

1 Introduction

This document describes the deployment, installation, back-out, and rollback instructions for the migration of Electronic Contract Management System (eCMS) from the Vitria Interface Engine (VIE) to InterSystems Health Connect (HC).

HC will replace VIE; currently in production, for the routing of eCMS messages.

This document includes information about:

- System support
- Issue tracking
- Escalation processes
- Roles and responsibilities involved in all activities

It provides clients, stakeholders, and support personnel with a smooth transition to Health Connect. It describes how to deploy and install the Health Connect in production as well as how to back out the product and roll back to a previous version or data set.



NOTE: In cases where you are installing a commercial-off-the-shelf (COTS) product, you can use the vendor-provided user guide and installation guide. However, if those guides do *not* include a back-out recovery and rollback strategy, you *must* retain that information in this document.

1.1 Purpose

The purpose of this guide is to provide a single, common document that describes how, when, where, and to whom Health Connect will be deployed and installed; as well as how it is to be backed out and rolled back, if necessary. The guide also identifies resources, communications plan, and rollout schedule. Specific instructions for deployment, installation, back-out, and rollback are included in this document.

1.2 Dependencies

VIE supports the routing of messages from several applications. The Health Connect product will ultimately be replacing VIE. During the transition phase both products will be running concurrently.

The success of HC as the messaging solution relies upon the availability of the VistA site administrators performing their part of the deployment in each VistA instance in a timely manner.

The installation of the shared Enterprise and Regional Health Connect instances is not within the scope of this deployment, which is dependent upon those instances being installed, configured, and running in production.

1.3 Constraints

HC is an approved product as per the VA’s Technical Reference Model (TRM).

2 Roles and Responsibilities

Table 1: Roles and Responsibilities

ID	Team	Phase / Role	Tasks	Project Phase (See Schedule)
	FM24 Project Management Office (PMO)	Deployment	Plan and schedule deployment (including orchestration with vendors).	
			Determine and document the roles and responsibilities of those involved in the deployment.	
	HC Operations	Deployment	Test for operational readiness.	
	Site and Vista Operations	Deployment	Execute deployment, including switch of logical link to HC.	
	HC Operations	Installation	Plan and schedule installation.	
			Ensure authority to operate and that certificate authority security documentation is in place.	
	InterSystems	Installations	Coordinate training as appropriate.	
	Development	Back-Out	Confirm availability of back-out instructions and back-out strategy (what are the criteria that trigger a back-out).	
	HC Operations/ Development/ InterSystems	Post Deployment	Hardware, Software, and System Support.	

3 Deployment

[Figure 1](#) depicts the current VistA Interface Engine (VIE) architecture for eCMS:

Figure 1: Current VIE Architecture for eCMS

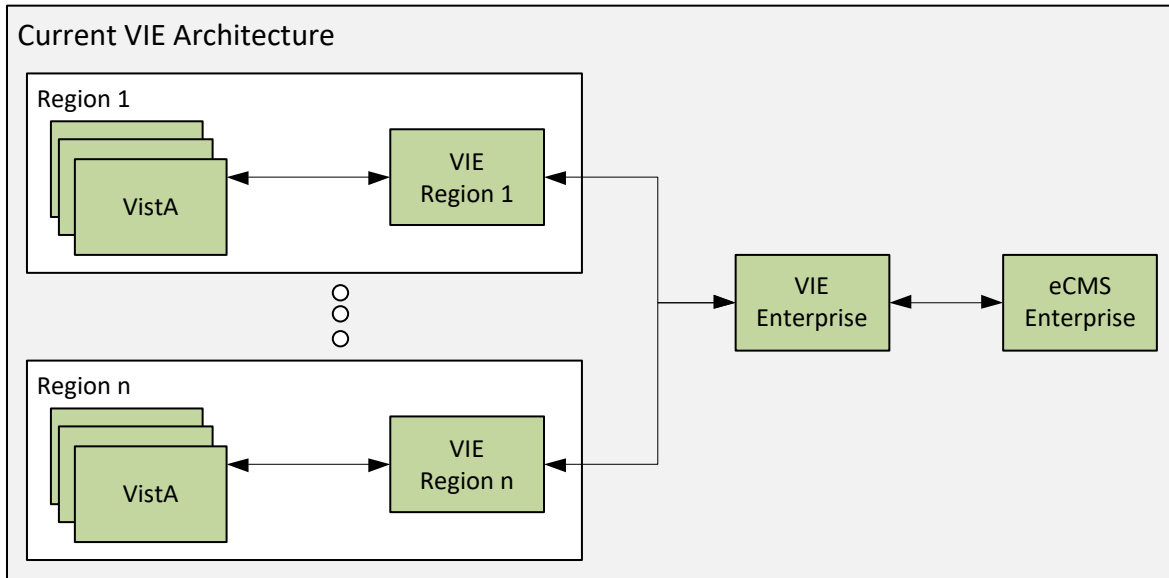

The FileMan 24 (FM24) IT PMO and Operations leadership have determined that a Rapid Deployment is the only feasible deployment strategy because of the technical limitation of the eCMS Enterprise system to connect to one messaging service at one time. Since eCMS can connect to either VIE or Health Connect, but not both, there must be a single switchover point in time.

In order to preserve message integrity and prevent message loss or substantial delay, a careful and deliberate set of steps must be followed in a specific order. VistA sites must quickly redirect new messages to avoid delayed communications between their site and eCMS.

Pre-Rollout Steps

The HealthShare Health Connect App Support/Operations team performs the following pre-rollout steps:

1. Installs the eCMS productions files onto the Enterprise Health Connect Instance and each of the Regional Health Connect instances.
2. Ensures all applicable ports are properly configured and opened.
3. Starts all productions
4. Enables all Services, Processes, and Operations, except for the Enterprise HC Operation **To_eCMS_5026**, which should be left disabled.

Figure 2: Deploy Health Connect Productions

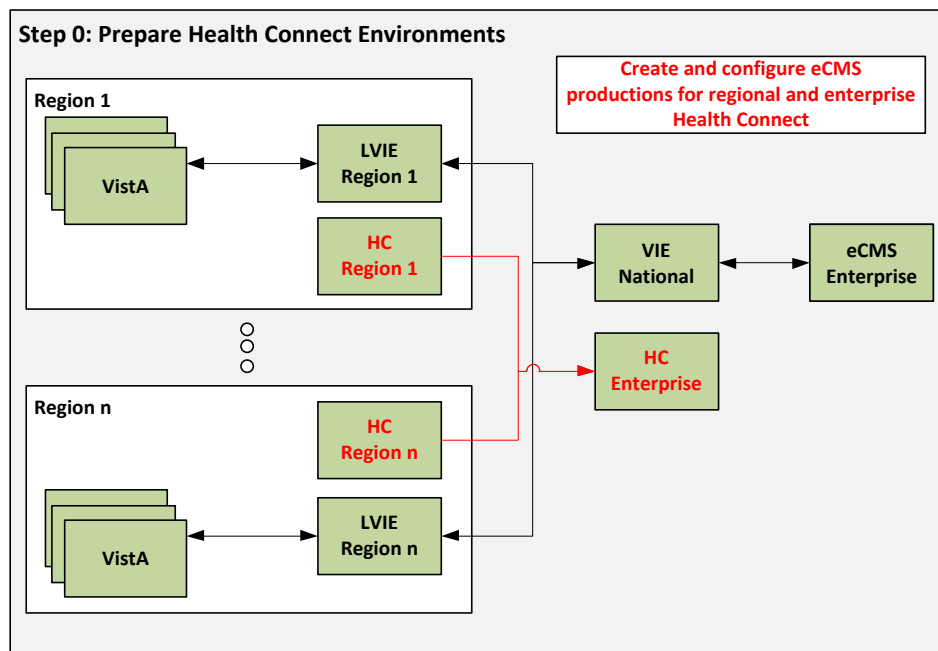

Rollout Procedure

Perform the following rollout steps:

1. The eCMS Operations team disables all outbound message flows. Until eCMS reconnects to HC Enterprise, no VistA sites will receive messages from eCMS.

Figure 3: Disable eCMS Outbound Flows

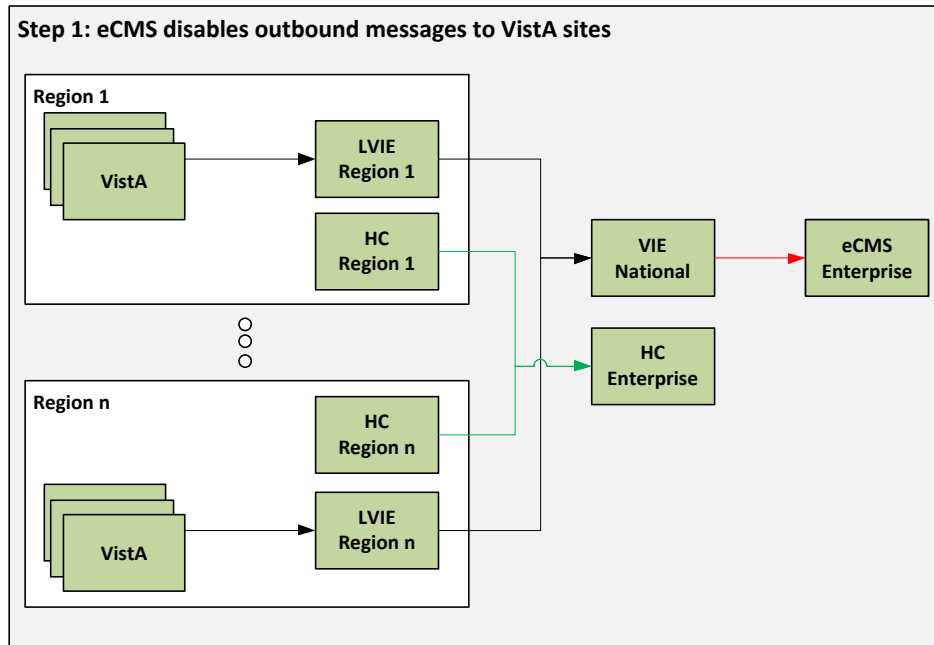

2. The HealthShare Health Connect App Support/Operations team ensures all eCMS to VistA messages are processed and cleared.
3. The Health Product Support team releases informational patch PRC*5.1*206 for 72-hour rapid release application.



NOTE: If the National team can coordinate the sites' execution of the patch instructions over a short period of time (i.e., one day), risk of stuck or duplicate transactions would be substantially reduced.

4. Each VistA site will redirect the outbound PRCHJ_ECMS logical link from the Local Vitria Interface Engine (LVIE) to the appropriate Regional Health Connect instance following the instructions in the PRC*5.1*206 patch, see Figure 4.

5. During this time period, VistA sites not yet redirected will still send messages through VIE and those will reach eCMS.
6. For sites that redirect their logical link, their messages will reach HC Enterprise and be held in queue until the patch time period is over, and eCMS connects to HC Enterprise. These sites will *not* receive application acknowledgements until that time as well. The transitioned VistA sites will receive commit acknowledgements as normal.
7. The Infrastructure Operations VistA Applications team will conduct conference calls to assist VistA sites with the redirection of the logical links, and to track compliance to the change.



NOTE: Each site will be provided the actual values to be entered in this step.

Figure 4: VistA HL7 Logical Link Screens

Main Screen

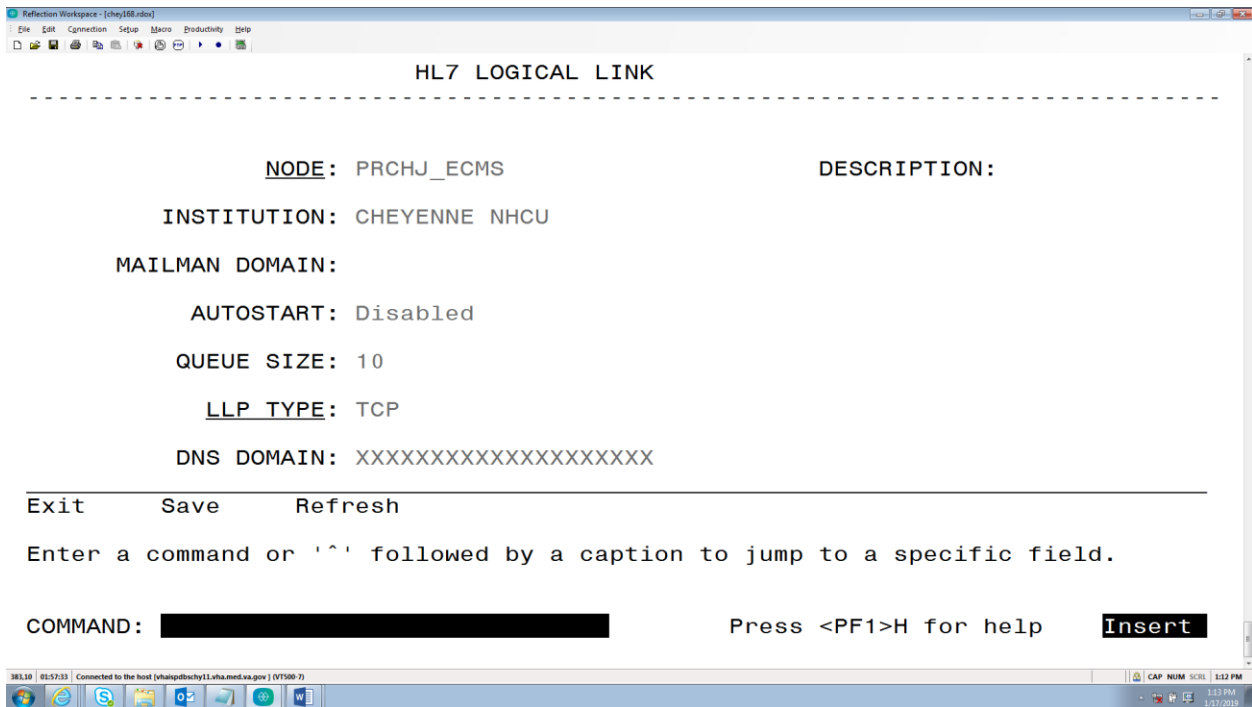

TCP Lower Level Parameter Screen

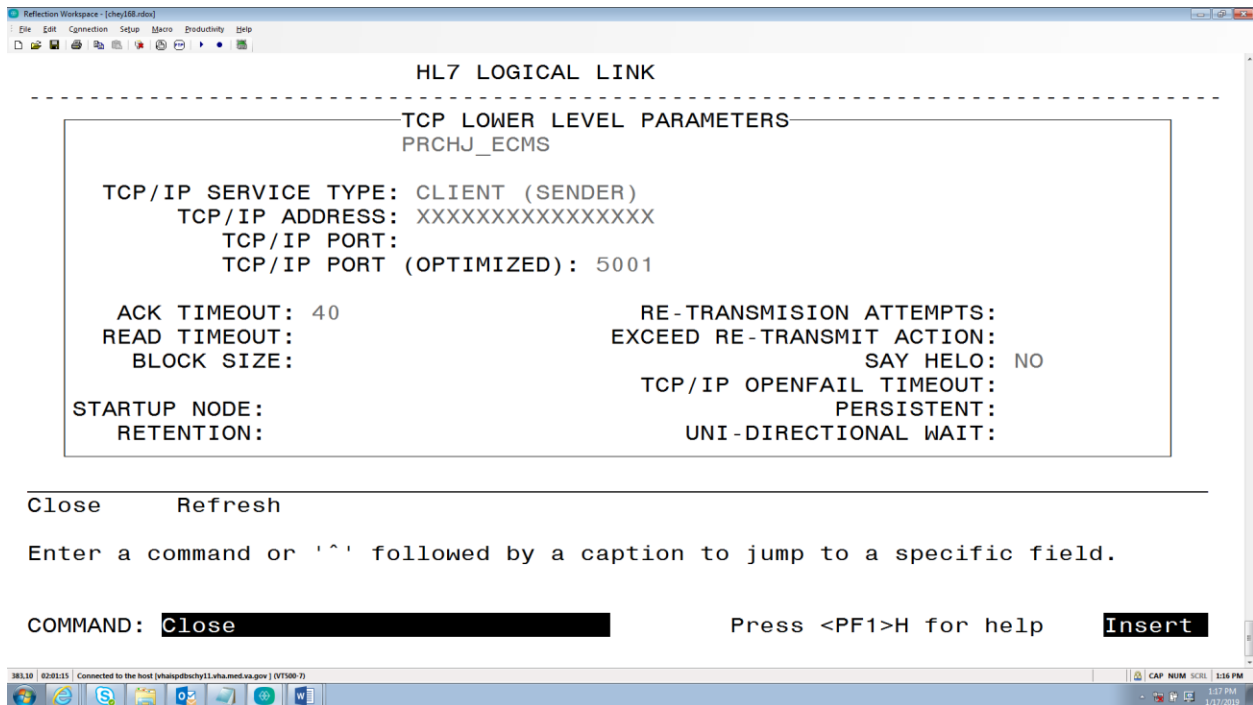

- a. Shut down the PRCHJ_ECMS Logical Link with the Start/Stop Links HL7 menu option.
- b. Edit the PRCHJ_ECMS Logical Link with the Link Edit HL7 menu option.
- c. On the main screen make sure that AUTOSTART is Disabled; and replace the existing DNS DOMAIN with the Health Connect domain.
- d. When in the TCP Lower Level Parameter screen (by hitting enter at the LLP TYPE field located on the main screen), replace the existing TCP/IP ADDRESS and existing TCP/IP PORT (OPTIMIZED) with the Health Connect IP address and Port.
- e. Do NOT start the PRCHJ_ECMS Logical Link once the edits have been completed.

.Figure 5: VistA Sites Start Redirecting Outbound Messages

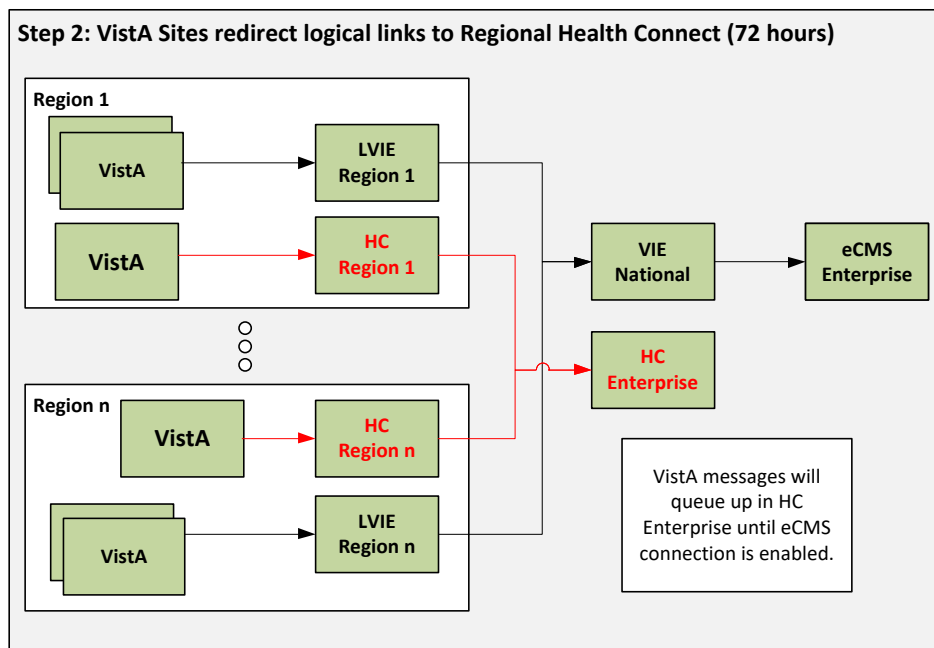

5. Once all VistA sites have complied with the transition to Health Connect, the HealthShare Health Connect App Support/Operations team monitors and validates that all:
 - eCMS related messages have passed through to their intended destination.
 - Local and national queues have been cleared.
 - eCMS VIE flows are disabled in the VIE network.
6. The eCMS Operations team connects its inbound queue to the Enterprise Health Connect instance and begins processing the queued messages.

Figure 6: eCMS Connects Inbound to HC

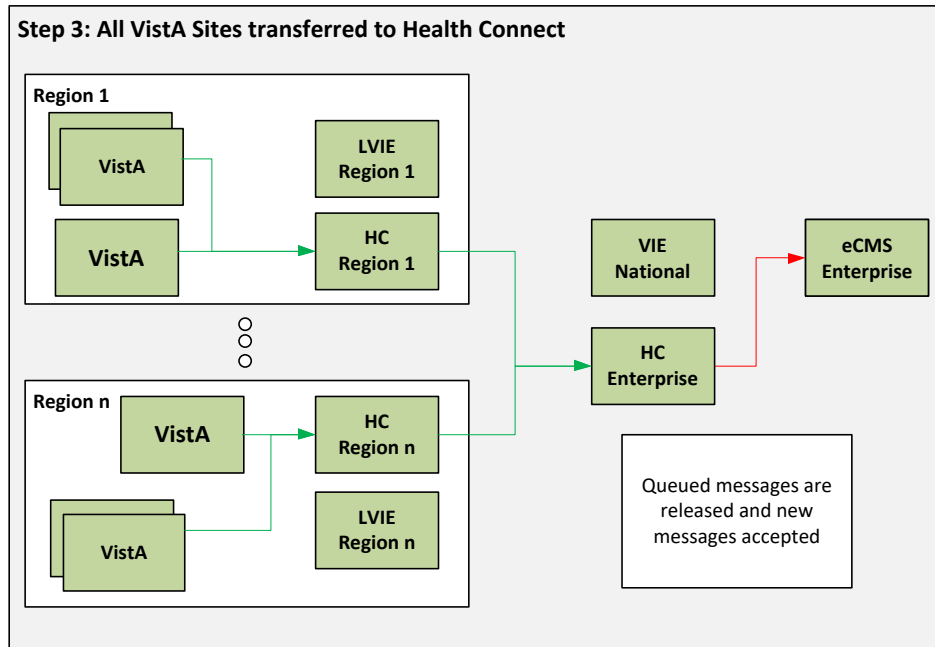

7. The eCMS Operations team connects outbound messages to VistA to the HC Enterprise instance.

Figure 7: eCMS Connection to HC for Outbound

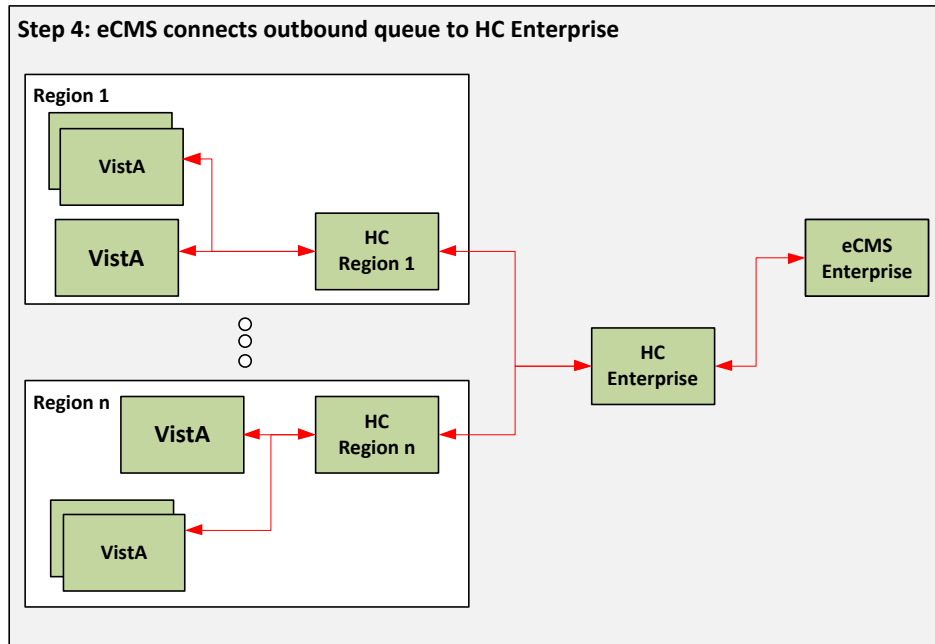

8. The HealthShare Health Connect App Support/Operations team monitors all eCMS productions on the Enterprise and Regional instances to ensure all messages are flowing appropriately.

3.1 Timeline

For timeline information, see the **VIE_eCMS_Checklist_V2.xlsx** Excel spreadsheet on SharePoint: (Sharepoint path is FileMan 24 – VIE Migration – eCMS)

https://vaww.oed.portal.va.gov/pm/iehr/vista_evolution/FileMan%2024/Forms/AllItems.aspx?RootFolder=%2Fpm%2Fiehr%2Fvista%5Fevolution%2FFileMan%2024%2FVIE%20Migration%2FeCMS



VIE_eCMS_Checklist
_V2.xlsx

3.2 Site Readiness Assessment

There are no preparatory steps at the VA medical center (VAMC) locations for the deployment of the eCMS messaging flows.

3.2.1 Deployment Topology (Targeted Architecture)

The final state, once all sites have deployed, is depicted in [Figure 8](#). VIE will no longer be used to pass messages related to eCMS and is removed from the target architecture. However, VIE will be used to manage other message types until they are also replaced.

Figure 8: Targeted eCMS Architecture

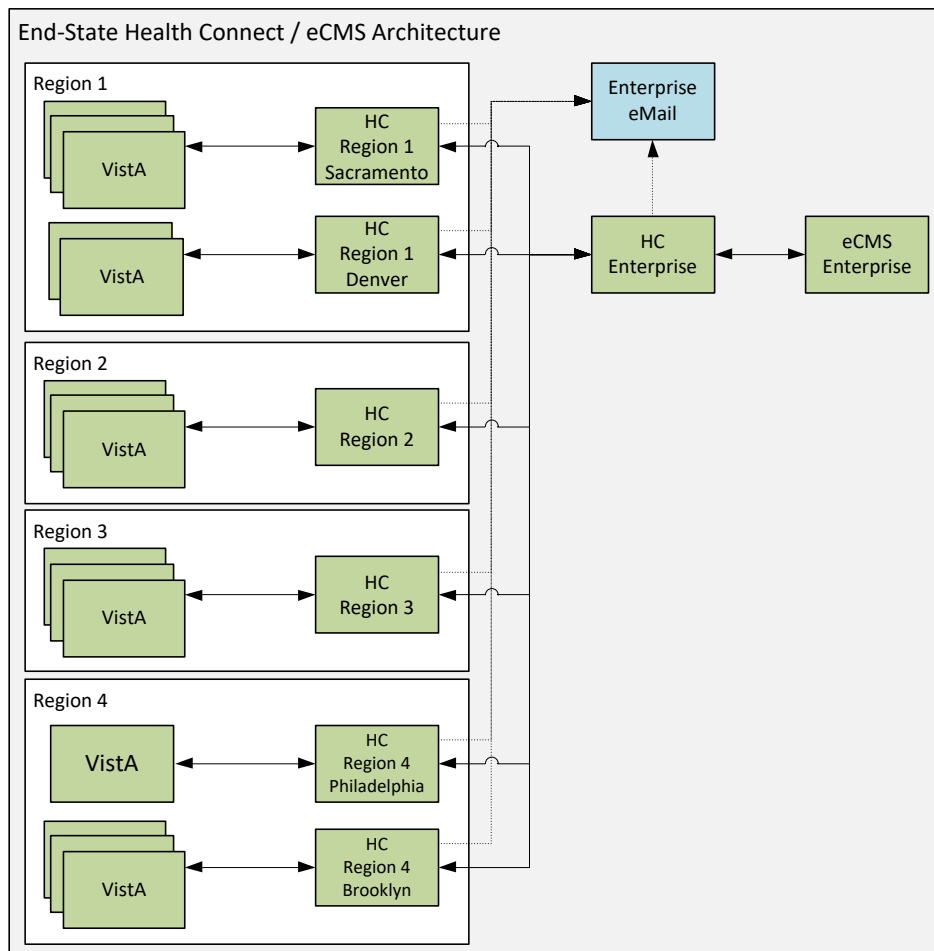

3.2.2 Site Information (Locations, Deployment Recipients)

The HealthShare Health Connect software has already been installed in production. There is one Enterprise instance, and six regional instances named:

- Region 1—Sacramento
- Region 1—Denver
- Region 2, Region 3, Region 4—Philadelphia
- Region 4—Brooklyn

Production Operations staff install the configurations specific to the eCMS message flows in each of these Health Connect instances.

The eCMS Enterprise production instance is reconfigured in its current location to connect to the Health Connect Enterprise production instance. No software changes are required.

Each VistA location that uses the Integrated Funds Control, Accounting, and Procurement (IFCAP) package to send and receive purchase requisitions will need to perform a reconfiguration of the IP address and Port for the HL7 Logical Link (#870) entry **PRCHJ ECMS**. No software changes are required.

3.2.3 Site Preparation

[Table 2](#) describes preparation required by the site prior to deployment.

Table 2: Site Preparation

Site/Other	Problem / Change Needed	Features to Adapt/Modify to New Product	Actions/Steps	Owner
HealthShare Health Connect Enterprise and Regional Instances	Install production configurations for eCMS message flows	Productions	Install Production definition file	HC Production Operations

3.3 Resources

The following support resources will be required during the transition of eCMS messages from VIE to Health Connect:

- Health Connect Support Operations Team
- VistA HL7 Support, VistA Administrators for each site
- eCMS Support Staff

3.3.1 Facility Specifics

This section does *not* apply to HL7 Health Connect and eCMS. Virtual meetings can be used to assist sites as needed.

3.3.2 Hardware

There are no special hardware requirements for sites using HL7 Health Connect and eCMS.

3.3.3 Software

The HC/eCMS software deployment is made up of the following:

eCMS Health Connect Production Extensible Mark-up Language (XML) files will be placed under configuration control in Rational CM.

3.3.4 Communications

Communications and notification activities include:

- The VistA administrators will be notified in advance via their monthly community call to introduce them to the strategy.
- Patch PRC*5.1*206 will be released from Forum to all VistA sites via rapid release information patch to be followed with **72** hours of release. The patch will contain the information necessary for the VistA administrator to connect to the appropriate Health Connect Regional instance.
- A series of “roll-call” conferences will be held when the patch is released to assist sites with redirecting the logical link and checking compliance.

3.3.4.1 Deployment/Installation/Back-Out Checklist

Refer to section 3.1

4 Installation

4.1 Platform Installation and Preparation

Platform installation and preparation steps are outlined in the sections below for PRC*5.1*206.

4.2 Download and Import Files

Definitions for eCMS Health Connect productions are available under Configuration Management in the VA Enterprise Ration CM instance. The files in [Table 3](#) should be downloaded to the respective Health Connect server. Each file contains specific definitions for each region and the enterprise instance, so they *must* be placed on the appropriate server for deployment.

Table 3: Download and Import Files

Health Connect Instance	Deployment XML Filename
Health Connect Region 1 - Sacramento	PROD_R1_Sacramento_eCMS.xml
Health Connect Region 1 – Denver	PROD_R1_Denver_eCMS.xml
Health Connect Region 2	PROD_R2_eCMS.xml
Health Connect Region 3	PROD_R3_eCMS.xml
Health Connect Region 4 – Brooklyn	PROD_R4_Brooklyn_eCMS.xml
Health Connect Region 4 – Philadelphia	PROD_R4_Philadelphia_eCMS.xml
Health Connect Enterprise	PROD_Enterprise_eCMS.xml

- As an administrator on the specific Health Connect Instance, access the **Deploy** option:
Management Portal (MP) → Ensemble → Manage → Deployment Changes → Deploy

Figure 9: Management Portal (MP)—Deployment Options

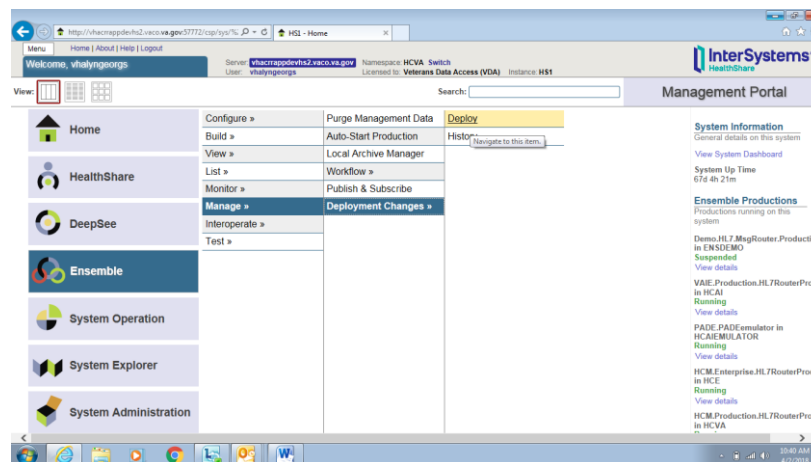

2. Select the eCMS XML deployment file, downloaded earlier Section 4.2, for the correct Health Connect instance. In this example [Figure 10](#), the file name is **ECMS_Region1Denver.xml**, but use the correct filename from [Table 3](#):

Open Deployment → Select Deployment file → OK

Figure 10: SM—Selecting Deployment File: eCMS

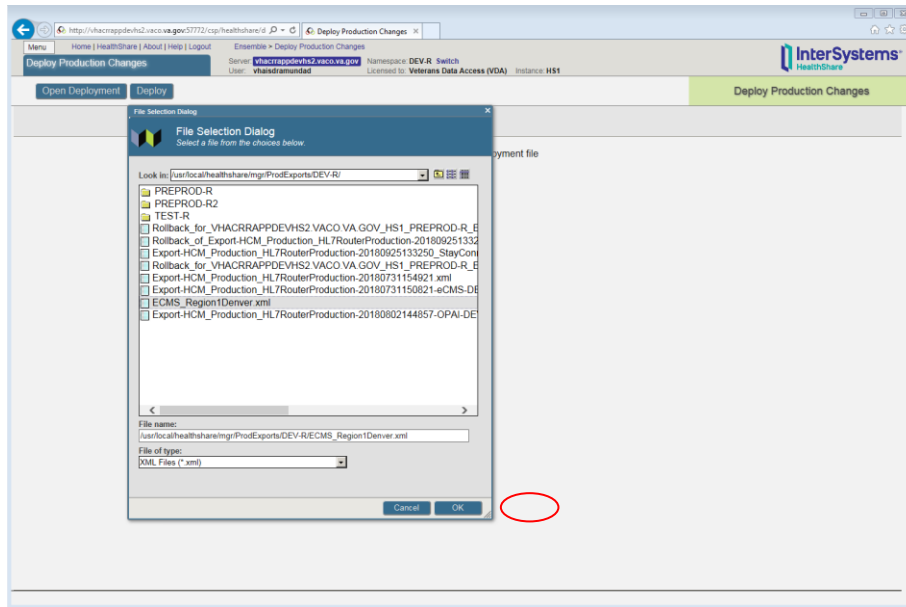

3. When you select **Deploy** [Figure 10](#), the “Deploy Production Changes” screen is displayed, as shown in [Figure 11](#):

Figure 11: SM—Deploy Production Changes Screen: eCMS

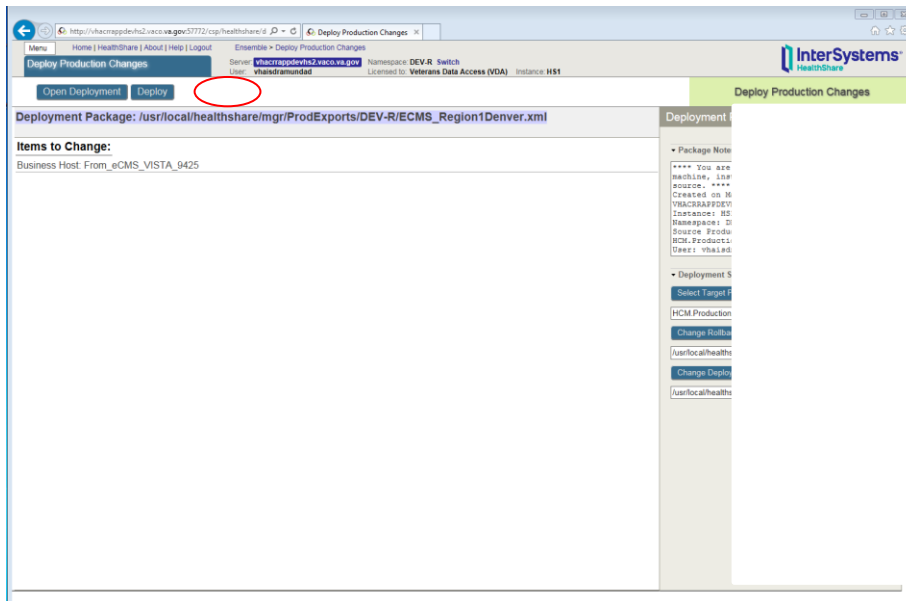

4. After deployment on each Health Connect instance, each production *must* be configured and enabled as described in Section [7.2](#), “[Appendix B—Configuring a Health Connect Production](#).”

4.3 Database Creation

There are no database creation steps for this deployment.

4.4 Installation Scripts

There are no installation scripts for this deployment.

4.5 Cron Scripts

Cron Scripts do *not* apply to the Health Connect/eCMS deployment.

4.6 Access Requirements and Skills Needed for the Installation

- A user with Health Connect administrative privileges on the Enterprise and Regional production instances will be required to deploy and configure the eCMS productions.
- At each VistA site, a user with HL7 Menu privileges in production will be required to reconfigure the eCMS logical link.

4.7 Installation Procedure

No software is being deployed. Configuration of the productions is described in Section [7.2](#), “[Appendix B—Configuring a Health Connect Production](#) .”

4.8 Installation Verification Procedure

Not applicable.

4.9 System Configuration

System configuration is described in in Section [7.2](#), “ [REF_Ref529359156 \h *](#) MERGEFORMAT [Appendix B—Configuring a Health Connect Production](#) .”

4.10 Database Tuning

Currently, no database tuning is expected or required for eCMS on HL7 Health Connect.

5 Back-Out Procedure

The back-out procedure documented in this section is basically the reverse of the deployment procedure. With a rapid roll-out strategy, a significant change to the messaging environment will occur quickly, so a back-out should be a last resort.

5.1 Back-Out Strategy

Since this is a first time install, the only back-out option is to un-deploy Health Connect (HC) and re-point eCMS to VistA Interface Engine (VIE) last known software configuration and platform settings.

The back-out process will re-point eCMS servers and the VistA logical links back to the VIE instance. This process will identify unsent eCMS messages on Health Connect and resend to eCMS/VistA.

The configuration and operational support will be in place as the VIE platform will still be in production, providing message routing for other applications. Coordination with each site and the operations teams (if VIE and Health Connect use different resources) for server configuration and VistA logical link update will be key to a successful back-out.

5.2 Back-Out Considerations

VIE (for remaining supported applications) and Health Connect (for migrated eCMS and other sites) will be running in parallel. Since both will be running before and after the deployment, a return to VIE would include reactivating the VIE/eCMS message flows.

The re-pointing of the eCMS server and VistA systems will need to be coordinated with site point of contact (POC), VIE, and Health Connect operations.

5.2.1 Load Testing

N/A

5.2.2 User Acceptance Testing

N/A

5.3 Back-Out Criteria

The primary criteria for a back-out decision will be any detrimental impact to patient care. If the deployed software and configuration is irreparably causing loss or damage to eCMS messages, a back-out may be preferable and timelier than repair to existing configurations. However, this is extremely unlikely given the extensive testing prior to deployment in production.

5.4 Back-Out Risks

Primary risks for a deployment back-out are the loss or corruption of messages during the back-out procedure. Risks also include impact to the program schedule and budget for re-work and re-deployment.

5.5 Authority for Back-Out

The decision to execute the back-out procedure may only be made by:

- Ken Leonard (FM24 Project Manager)
- Annette Parsons (HC Operations Project Manager)

5.6 Back-Out Tasks

The steps for the back out tasks are below.

5.6.1 VIE Message Flows

The VIE message flows specific to eCMS should be reactivated back to their pre-deployment state.

5.6.2 Health Connect Flows

The inbound flows from the VistA sites on the Regional Health Connect instances should be disabled so that no additional messages may be sent. The inbound flow from eCMS to the Enterprise Health Connect instance should be disabled so that new messages from eCMS may not be sent. The Health Connect production operations staff should ensure all eCMS messages have been processed through to eCMS or the appropriate VistA instance before deactivating the productions.

5.6.3 eCMS Connection

The eCMS production operations team should disconnect its connection to the Health Connect Enterprise instance and reconnect to the VIE Enterprise instance.

5.6.4 VistA Sites Repoint to VIE

An informational patch will need to be released to instruct each of the VistA sites to repoint their Logical Link for eCMS back to the VIE Regional instance they used prior to the deployment.

5.7 Back-Out Verification Procedure

The following group will determine if messages remain on the VIE server if back out is required:

VIE National Admins (VIENationalAdmins@va.gov)

6 Rollback Procedure

Due to the nature of the deployment strategy and messaging architecture, a roll-back of processed data is unrealistic and unnecessary. Since the source and target systems do *not* change during the deployment, messages will be processed after the deployment the same way as prior to deployment. Therefore, even if the messaging infrastructure is changed back, no roll-back of data or messages will be required.

7 Appendices

7.1 Appendix A—Health Connect Production Namespace Configuration and Deployment



NOTE: Sections 7.1.1 and 7.1.2 are included for completeness, but should *not* be necessary, since they should already have been completed at this point by previous Fileman 24 Health Connect application installs.

7.1.1 Creating a New Namespace

To create a new namespace in Health Connect Production, do the following:

1. Open the following:
System Administration → Configuration → System Configuration → Namespace
2. Click **Create New Namespace**.
3. Enter the Name of the namespace **HCM**.
4. Create new database.
5. Enter the name of your database **HCM**.
6. Click on **browse** next to **Create your directory** and create a folder with the name of your database **HCM**.
7. Click **Next** on the bottom of the screen; use the default settings or the ones recommended by the site administrator.
8. Click **Next** and select the default.
9. Click **Finish**.
10. Click on the dropdown **Select an existing database for Routines** and select the database folder created in [Step 6](#) **HCM**.
11. Click **Save**.
12. Namespace **HCM** will be added to the list of namespaces.

7.1.2 Deploying a Health Connect Production

To deploy a Health Connect Production, do the following:

1. Copy the deployment file (e.g., **Export-HCM_Production_HL7RouterProduction-Deploy1.0.xml**) to a path and directory in HealthShare. For example:
/tmp/
2. On the “Health Connect” page, click on the switch that brings a window of all the namespaces.

3. Click on **HCM**. Verify the namespace value is now changed to **HCM**.
4. Click on **Ensemble → Manage → Deployment changes → Deploy**.
5. Click on **Open Deployment** and select the directory in [Step 1](#).
6. Select the Deployment file (e.g., **Export-HCM_Production_HL7RouterProduction-Deploy1.0.xml**).
7. The “Deployment Production Changes” screen will display the artifacts that were brought in as part of the **xml** file.
8. Click on the **Deploy** tab.
9. Deployment will begin. This will take a few minutes.
10. Go to the following:
Ensemble → List → Select HCM.Production.HL7RouterProduction

7.2 Appendix B—Configuring a Health Connect Production

Once each respective production XML file has been deployed (see Section 4.2, “Download and Import Files”), the eCMS Health Connect configuration will need to be performed on the Enterprise Health Connect instance, and each of the six Regional Health Connect instances.

7.2.1 Configuring Each Regional Health Connect Production

For each Regional eCMS Production instance, do the following enable and properly direct messages to the correct location:

1. Each Regional instance will be responsible for sending messages that are initiated in eCMS (and flow through the Enterprise Health Connect instance) to the correct VistA instance and port. **The eCMS_InRouter** process will accept messages from the Enterprise Health Connect instance, and use the Lookup Table **HCM.InboundRouter.Table5001** to route the message to the appropriate VistA instance and port. From the Management Console:
 - a. Navigate to **Ensemble → Configure → Data Lookup Tables**.
 - b. Select the **Open** button.
 - c. Select **HCM > InboundRouter > Table5001**.
 - d. For each VistA instance to which messages will be sent for the region, there should be an entry (key-value pair) that lists the receiving facility (key) and the name of the outbound Operation (value). For example, **HL7.<siteName>.MED.VA.GOV:<port>** (e.g., HL7.CHEYENNE.MED.VA.GOV:5632) would map to value **To_VISTA<site>_<port>** (e.g. To_VISTA442_5001).
 - e. A list of these key-value pairs will be sent separately to each Regional Health Connect administrator for entry into this table.
 - f. If any values are missing, enter the key and value in the right-hand column and hit the **Apply** button.
2. Configure connection details on Business Operations to properly direct outbound messages. A separate listing will be provided for each Region and Enterprise Health Connect administrator with proper values for configuration. For messages directed to eCMS, the outbound operation is to the Enterprise Health connect production, which will forward the message to eCMS. Also repeat this step for each of the VistA instances listed under the Operations column:
 - a. First, ensure that there is a System Default Setting with the IP Address or Fully Qualified Domain name of the Enterprise Health Connect instance, or the VistA instance to which messages will be sent.



NOTE: IP Addresses and/or FQDN will be communicated to each system administrator separately.

- i. Navigate to **Ensemble → Configure → System Default Settings**.
- ii. Look for an Item Name of **To_eCMSEnt_<port>** or **To_VISTA<site>_<port>**.
- iii. If it already exists, skip to [Step 2b](#).
- iv. Select the **New** button and enter the following:
 1. Production = **HCM.Production.HL7RouterProduction**
 2. Item Name = **To_eCMSEnt_<port>** or **To_VISTA<site>_<port>**
 3. Host Class Name = **EnsLib.HL7.Operation.TCPOperation**
 4. Setting Name = **IPAddress**
 5. Setting Value = *<IP Address or FQDN communicated separately>*
 6. Click the **Save** button.
- b. Navigate back to the Production listing (**Ensemble → Configure → Production**). To isolate eCMS components: select “eCMS” from the Category dropdown. Select an outbound business operation (e.g., **To_eCMSEnt_<port>** or **To_VISTA<site>_<port>**).
- c. Click on the **Settings** tab on the right.
- d. Select the **Enabled** checkbox.
- e. Select the **Restore Default Values** button ().
- f. Select the blue **IP Address** setting and the **Port** setting (which should match the Operation name).
- g. Scroll to the bottom and select the **Restore Default** button. The IP Address label should turn **blue**.
- h. Click **Apply**.
3. Each of the four message handling Operations (e.g., **BadMessageHandlerAll**, **BadMessageHandlereCMS**, **EmailAlert.OperationAll**, **EmailAlert.OperationeCMS**) are deployed as enabled, and each should show as a status of **Enabled** (green indicator). If any are *not* enabled:
 - a. Select the Operation that has a grey indicator.
 - b. Click on the **Settings** tab on the right.
 - c. Select **Enabled** checkbox.
 - d. Click **Apply**.
4. Each of the four Business Processes (e.g., **eCMS_InRouter**, **eCMS_OutRouter**, **OutRouter**, **InRouter**, and **Ens.Alert**) are deployed as enabled, and each should show as a status of **Enabled** (green indicator). If any are *not* enabled:
 - a. Select business process related to eCMS.
 - b. Click on **Settings** tab on the right.
 - c. Select **Enabled** checkbox.

- d. Click **Apply**.
5. Configure connection details on Business Services to allow inbound messages:
 - a. From the **Management Portal → Ensemble → Configure → Production**.
 - b. There should be two inbound Business Services:
 - Messages initiated in VistA to eCMS
 - Accepting messages initiating in eCMS to a VistA in the respective region.
 - c. Select the business service from eCMS to VistA (e.g., **From_eCMS_VISTA_<port>**). This will allow messages from Enterprise Health Connect to be accepted into this Regional Health Connect.
 - d. Click on the **Settings** tab on the right.
 - e. Select the **Enabled** checkbox.
 - f. Click **Apply**.
 - g. Select the business service from VistA to eCMS (e.g., **From_VISTA_eCMSEnt_<port>**). This will allow messages from a VistA instance to be accepted into this Regional Health Connect.
 - h. Click on the **Settings** tab on the right.
 - i. Select the **Enabled** checkbox.
 - j. Click **Apply**.

7.2.2 Configuring Enterprise Health Connect Production

While similar to the steps in Section [7.2.1](#) for the Regions, the Enterprise instance of Health Connect is configured slightly differently. The Enterprise Health Connect instance is responsible for forwarding messages from eCMS to the appropriate Regional Health Connect instance (for later forwarding to the destination VistA instance). Each message from eCMS contains a destination facility in the message header, which will be used to route the message to the correct region using table **HCM.InboundRouter.Ecms**

1. Populate the table **HCM.InboundRouter.Ecms** using the steps below:
 - a. Navigate to **Ensemble → Configure → Data Lookup Tables**.
 - b. Select the **Open** button.
 - c. Select **HCM 0 → InboundRouter → Ecms**.
 - d. Verify an entry exists for each VistA instance to which messages will be sent. For the region, there should be an entry (key-value pair) that lists the receiving facility (**key**) and the name of the outbound Operation for the Region to which the message will be routed (**value**). For example, **HL7.<siteName>.MED.VA.GOV:<port>** (e.g., HL7.CHEYENNE.MED.VA.GOV:5632) would map to value **To_VISTARegion1_eCMS_<port>** (e.g., To_VISTARegion1_eCMS_9425).
 - e. A list of these key-value pairs will be sent separately to the Enterprise Health Connect administrator for entry into this table. Verify each entry exists and create entries if needed.
 - f. If any values are missing, enter the key and value in the right-hand column and click the **Apply** button.

2. Configure connection details on Business Operations to properly direct outbound messages. For messages directed to eCMS, the outbound operation is to the enterprise eCMS instance. There will also be one Operations entry for each Regional instance of Health Connect. Repeat this step for each of the Regional instances listed under the Operations column:
 - a. First, ensure that there is a **System Default Setting** with the IP Address or Fully Qualified Domain name of each Regional Health Connect instance, and the enterprise eCMS instance to which messages will be sent.



NOTE: IP Addresses and/or FQDN will be communicated to each system administrator separately.

- i. Navigate to **Ensemble → Configure → System Default Settings**.
- ii. Look for an Item Name of **To_eCMS_<port>** or **To_VISTARegion<region>_eCMS_<port>**
- iii. If it already exists, skip to [Step 2b](#).
- iv. Select the **New** button and enter the following:
 1. Production = **HCM.Production.HL7RouterProduction**
 2. Item Name = **To_eCMS_<port>** or **To_VISTARegion<region>_eCMS_<port>**
 3. Host Class Name = **EnsLib.HL7.Operation.TCPOperation**
 4. Setting Name = **IPAddress**
 5. Setting Value = *<IP Address or FQDN communicated separately>*
 6. Click the **Save** button.
- b. Navigate to the Production listing (**Ensemble → Configure → Production**). To isolate eCMS components, select “**eCMS**” from the Category dropdown. Select an outbound business Operation (e.g., **To_eCMS_<port>** or **To_VISTARegion<region>-eCMS_<port>**).
- c. Click on the **Settings** tab on the right.
- d. Select the **Enabled** checkbox.
- e. Select the **Restore Default Values** button (.
- f. Select the blue **IP Address** setting and the Port setting (which should match the Operation name).
- g. Scroll to the bottom and select the **Restore Default** button. The IP Address label should turn [blue](#).
- h. Click **Apply**.

3. Configure connection details on Business **Services** to allow inbound messages:
 - a. From the **Management Portal** → **Ensemble** → **Configure** → **Production**.
 - b. To isolate eCMS components, select “**eCMS**” from the Category dropdown. There should be two inbound Business Services:
 - Messages from the Regional Health Connect instances addressed to eCMS.
 - Accepting messages initiating in eCMS to a VistA in the respective region.
 - c. Select the business Service from eCMS to VistA (e.g., **From_eCMSEnt_VISTA_<port>**). This will allow messages from eCMS to be accepted into this Enterprise Health Connect instance.
 - d. Click on the **Settings** tab on the right.
 - e. Select the **Enabled** checkbox.
 - f. Click **Apply**.
 - g. Select the business service from VistA to eCMS (e.g., **From_VISTA_eCMS_<port>**). This will allow messages from a Regional Health Connect instance (originally from VistA) to be accepted into this Enterprise Health Connect.
 - h. Click on the **Settings** tab on the right.
 - i. Select the **Enabled** checkbox.
 - j. Click **Apply**.
4. If the four message handling Operations (e.g. **BadMessageHandlerAll**, **BadMessageHandlereCMS**, **EmailAlert.OperationAll**, **EmailAlert.OperationeCMS**) do *not* have a status of Enabled (green indicator), ensure each is enabled:
 - a. Select the Operation that has a grey indicator
 - b. Click on the **Settings** tab on the right.
 - c. Select **Enabled** checkbox.
 - d. Click **Apply**.
5. Enable the business process:
 - a. Select business process related to eCMS (e.g., **eCMSInRouter** and **Ens.Alert**).
 - b. Click on **Settings** tab on the right.
 - c. Select **Enabled** checkbox.
 - d. Click **Apply**.

7.3 Appendix C—Starting and Stopping a Health Connect Production



REF: For details on what occurs when you start or stop a production, see the InterSystems book *Managing Ensemble Productions*.

7.3.1 Starting Health Connect Production

To **start** a Health Connect Production, do the following:

1. Log in to the **Management Portal**.
2. Change to the appropriate namespace.
3. Go to the “Production List” page:
Ensemble → List → Productions
4. Find the **production** in the list and click it.
5. Click the **Open** button at the top of the list.
6. On the resulting “Production Configuration” page, click **Start** to display a dialog box.
7. In the dialog box, click **Open**. The system displays a new dialog box with the name of the **production**, its startup status, and any associated messages.



NOTE: The system may also open Terminal windows. Do *not* close these windows. Click the **OK** button when it is displayed in the dialog box.

7.3.2 Stopping Health Connect Production

To **stop** a Health Connect Production, do the following:



NOTE: During this process ensure the Health Connect operation is **disabled** (see [Appendix B, Step 2](#), “Configure connection details on Business Operations”).

1. Log in to the HealthShare **Management Portal**.
2. Change to the appropriate namespace.
3. Go to the “Production List” page:
Ensemble → List → Productions
4. Find the **production** in the list and click it.
5. Click the **Open** button at the top of the list.
6. On the resulting “Production Configuration” page, click **Stop** to display a dialog box.

7. In the dialog box, click **OK**. The system displays a new dialog box with the following:
 - Name of the production.
 - Shutdown status.
 - Any associated messages.



NOTE: The system may also open Terminal windows. Do *not* close these windows. Click the **OK** button when it is displayed in the dialog box.