

Electronic Insurance Verification User Guide



**Version 2.0
January 2014**

**Veterans Affairs
Product Development (PD)**

Revision History

Date	Version	Description	Author
9/18/03	1.0	IB*2*184	Darlene White
2/08/05	1.1	Updated IB*2*271	Darlene White
7/28/05	1.2	Updated IB*2*300	Ron Oshrin
5/06/05	1.3	Updated IB*2*316	Ron Oshrin
9/24/10	1.4	Updated IB*2*416	M. Simons / Jonathan Bolas
8/02/11	1.5	Updated IB*2*438	Jonathan Bolas/Gianni LaRosa
11/17/11	1.6	Updated IB*2*467	Gianni LaRosa
12/20/11	1.7	Tech Writer Review	Gianni Larosa
1/29/14	2.0	Updated IB*2*497	FirstView Team

TABLE OF CONTENTS

1	INTRODUCTION.....	1
1.1	ELECTRONIC INSURANCE VERIFICATION (EIV) PROCESS FLOW	1
1.2	INTENDED AUDIENCE	2
1.3	THE ROLE OF THE INSURANCE VERIFICATION INTERFACE.....	2
1.4	NATIONAL INSURANCE PAYERS	3
2	SITE PARAMETERS	6
2.1	DEFINE GENERAL PARAMETERS.....	7
2.2	DEFINE BATCH EXTRACT PARAMETERS	9
2.3	STORE DEFAULT SERVICE TYPE CODES	10
3	PAYERS	12
3.1	LINK INSURANCE COMPANY TO PAYERS USING LINK INSURANCE COMPANY TO PAYERS... 12	
3.2	LINK INSURANCE COMPANY TO PAYERS USING INSURANCE COMPANY EDITOR.....	14
3.3	PAYER EDIT (ACTIVATE/INACTIVATE)	17
4	PROCESS INSURANCE BUFFER	19
4.1	STATUS FLAGS.....	19
4.1.1	<i>Buffer Symbols</i>	<i>19</i>
4.1.2	<i>Buffer Entry Status Flags.....</i>	<i>19</i>
4.1.3	<i>Patient Status Flags.....</i>	<i>19</i>
4.1.4	<i>Buffer Entry Source of Information Indicators.....</i>	<i>20</i>
4.1.5	<i>Insurance Entry Update Methods.....</i>	<i>20</i>
4.2	BUFFER ACTIONS	20
4.2.1	<i>Process Entry</i>	<i>21</i>
4.2.2	<i>Reject Entry.....</i>	<i>27</i>
4.2.3	<i>Expand Entry.....</i>	<i>28</i>
4.2.4	<i>Add Entry.....</i>	<i>30</i>
4.2.5	<i>Sort Buffer Views.....</i>	<i>32</i>
4.2.6	<i>Check Insurance Company.....</i>	<i>33</i>
4.2.7	<i>Positive View/Negative View/Medicare View/Appointment View</i>	<i>34</i>
4.2.8	<i>AAA Errors – - Negative Buffer View, Response Report.....</i>	<i>34</i>
4.3	MEDICARE POTENTIAL INSURANCE WORKLIST - POTENTIAL COB REPORT.....	36
4.3.1	<i>Search Criteria - Potential COB Worklist.....</i>	<i>37</i>
4.3.2	<i>Sort Criteria – Potential COB Worklist.....</i>	<i>37</i>
4.3.3	<i>Format – Potential COB Worklist</i>	<i>37</i>
4.3.4	<i>Screen ListManager for Completed Entries – Potential COB Worklist.....</i>	<i>37</i>
4.3.5	<i>ListManager – Potential COB Worklist.....</i>	<i>37</i>
4.3.6	<i>Comments – Potential COB Worklist</i>	<i>37</i>
4.3.7	<i>Visual Indicators – Potential COB Worklist.....</i>	<i>37</i>
5	REQUEST ELECTRONIC INSURANCE INQUIRY	40
5.1	REQUEST A 270 HEALTH CARE + BENEFITS INQUIRY	40
6	PATIENT INSURANCE INFO VIEW/EDIT	42
6.1	VIEW PATIENT POLICY INFORMATION	42
6.2	VIEW ELIGIBILITY BENEFIT INFORMATION	48

7	IIV AUTO MATCH PAYERS	51
7.1	AUTO MATCH IN VISTA APPLICATIONS	51
7.2	TYPES OF AUTO MATCH MATCHES	52
7.2.1	<i>Simple Auto Match Matches</i>	52
7.2.2	<i>Wildcard Auto Match Matches</i>	52
7.3	MAINTAIN THE AUTO MATCH ENTRIES.....	53
7.4	CHECK INSURANCE BUFFER COMPANY NAMES	54
7.5	CHANGE COMPANY NAME VIA THE INSURANCE BUFFER	56
8	EIV REPORTS	64
8.1	EIV PATIENT INSURANCE UPDATE REPORT	64
8.2	EIV RESPONSE REPORT	65
8.3	EIV PAYER REPORT.....	67
8.4	MEDICARE POTENTIAL INSURANCE WORKLIST - POTENTIAL COB WORKLIST/REPORT	68
8.4.1	<i>Medicare Potential COB – as a Worklist</i>	69
8.4.2	<i>Medicare Potential COB – as a Report</i>	70
8.5	EIV STATISTICAL REPORT	71
8.6	EIV PAYER LINK REPORT	73
8.7	MAILMAN SUMMARIES	74
8.8	MAILMAN NOTIFICATION TO LINK PAYERS	75
8.9	MAILMAN NOTIFICATION TO ACTIVATE PAYERS	76
8.10	EIV AMBIGUOUS POLICY REPORT	76
8.11	EIV INACTIVE POLICY REPORT	78
9	SCHEDULE/UNSCHEDULE MAILMAN MESSAGES	81
10	REAL TIME INSURANCE VERIFICATION INQUIRY	83
11	PURGING EIV FILES (IRM USERS).....	85
11.1	PURGE TRANSMISSION QUEUE AND OR RESPONSE FILE	85
11.2	PURGE MAILMAN REMINDER	86
12	APPENDIX A – EIV TROUBLESHOOTING.....	88
12.1	NO EIV INQUIRIES TRANSMITTED.....	88
12.1.1	<i>Site Parameters</i>	88
12.1.2	<i>Restoring Connectivity to FSC (IRM)</i>	88
12.1.3	<i>Requeue Batch Process (IRM)</i>	88
12.1.4	<i>Restart HL7 Logical Link (IRM)</i>	89
12.2	NO LINK BETWEEN AN INSURANCE COMPANY AND A PAYER.....	89
12.3	A BUFFER OR APPOINTMENT EXTRACT ENTRY FAILED TO CREATE AN INQUIRY	89
13	APPENDIX B – EIV ERROR MESSAGE DESCRIPTIONS.....	91
14	APPENDIX C – ACRONYMS/ABBREVIATIONS/TERMS	97

1 INTRODUCTION

In 1996, Congress passed into law the Health Insurance Portability and Accountability Act (HIPAA). This Act directs the federal government to adopt national electronic standards for automated transfer of certain health care data between health care payers, plans, and providers. Now that these standards are in place, the Veterans Health Administration (VHA) will submit electronic 270 Health Care Benefits Eligibility Inquiries to payers and receive 271 Health Care Benefits Eligibility Responses from the payers.

1.1 Electronic Insurance Verification (eIV) Process Flow

The VistA users enter patient insurance information through a variety of processes:

- Insurance information may be entered manually during the Registration process
- It may be entered when the patient's insurance card is read by the insurance card reader
- A user may enter patient's insurance information directly into the Patient file using the Patient Insurance Info View/Edit option

Regardless of how the patient's insurance information gets entered into VistA, it must be verified with the insurance company and the verification must be periodically updated. The goal of the eIV process is to automate as much of the verification process as possible to ensure that the insurance information, used to submit claims for services rendered to the patient, is accurate and up-to-date. This in turn, increases the likelihood of timely reimbursement and increased revenue.

The eIV interface is bi-directional. The HIPAA Health Care Eligibility Benefit Inquiry transaction is referred to as the 270 and the Response is referred to as the 271. The 270 Health Care Eligibility Benefit Inquiry originates at a VAMC VistA system and is transmitted as a Health Level Seven (HL7) message to the Eligibility Communicator at the Financial Services Center (FSC) in Austin, TX. At FSC, the HL7 message is translated into a HIPAA compliant 270 Health Care Eligibility Benefit Inquiry message and sent to one of the VA's clearinghouses. From the clearinghouse, the 270 message is transmitted to the designated payer.

The 271 Health Care Eligibility Benefit Response originates at the payer and is sent to FSC through the clearinghouse. FSC translates the response back into an HL7 message and transmits it to the originating VAMC VistA system.

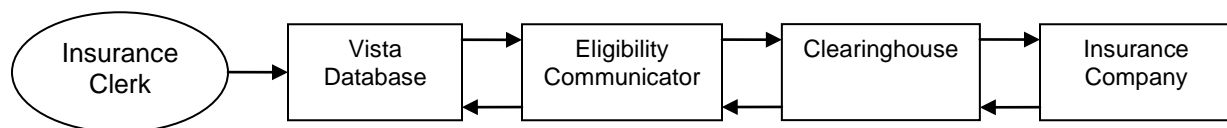

Figure 1. eIV Process Flow

1.2 Intended Audience

The information in this guide is primarily intended for those users who create, update, accept and reject insurance buffer entries or otherwise maintain patients' insurance data using VistA Integrated Billing (IB) software.

1.3 The Role of the Insurance Verification Interface

The goal of the electronic insurance verification software is to replace much of the telephone work performed by insurance personnel to verify patients' health care insurance.

Electronic insurance inquiries can be made to any electronically active payer.

Automating the insurance verification process should result in an increase in the accuracy and timeliness of patient insurance information in VistA. These improvements will, in turn, reduce the number of rejected third-party claims for services rendered to the Veteran by the Veteran's Administration (VA).

VistA performs both a Buffer Extract and an Appointment Extract. For the Appointment Extract; VistA prepares HL7 inquiries during the night in response to appointment events. For the Buffer Extract, VistA immediately prepares HL7 inquiries in response to registration and check in events. The HL7 inquiries are transmitted to the Eligibility Communicator at the FSC. The messages are translated into 270 Health Care Eligibility Benefits Inquiry messages. They are then sent to the VA's clearinghouses who then distribute them to the correct insurance companies. The 271 Health Care Eligibility Benefits Responses are returned from the payer through the clearinghouses to FSC for translation into an HL7 format and then transmitted to the originating VistA system. There the information is either placed into the insurance buffer for the insurance clerk to review and process to the patient's insurance file or used to automatically update the patient's insurance file.

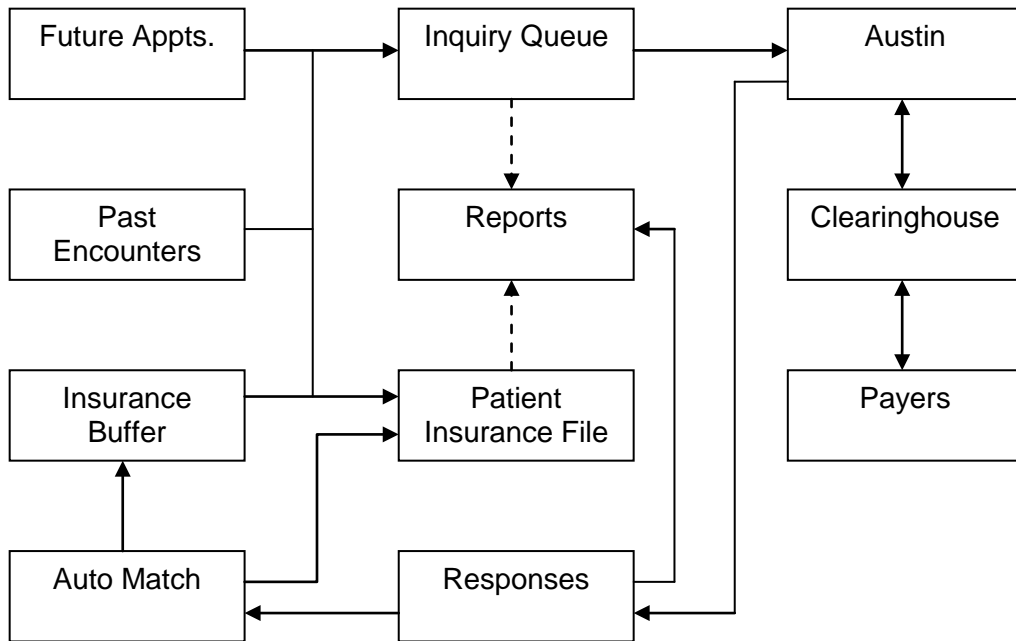

Figure 2. Flowchart of eIV Processes

Automatic updates are made only when a response meets pre-determined criteria. The criteria vary slightly depending upon the situation (e.g. Non-Medicare insurance when the Patient is the Insurance Subscriber will be different from Non-Medicare insurance when the Patient is a dependent of the Insurance Subscriber). Below is an example of some of the criteria:

1. Automatic Update Setting = Yes; and
2. Subscriber ID (VistA) = Subscriber ID (271 Response); and
3. Subscriber DOB (VistA) = Subscriber DOB (271 Response); and
4. Subscriber's Name (VistA) = Subscriber Name (271 Response) and
5. Group Number (VistA) = Group Number (271 Response),

Note: The **Automatic Update Setting** is also referred to as the **Trusted Payer Flag**.

1.4 National Insurance Payers

In order for the various VistA sites to be able to request eligibility information from the various payers, a national VA insurance payer list has been established. The national payer list provides a standard identification system for all payers that are participating in this process. Each VistA site has the ability to link the insurance companies in their own database to the appropriate payer in the national payer list. This standardizes the identification of the payer to which each inquiry will be directed.

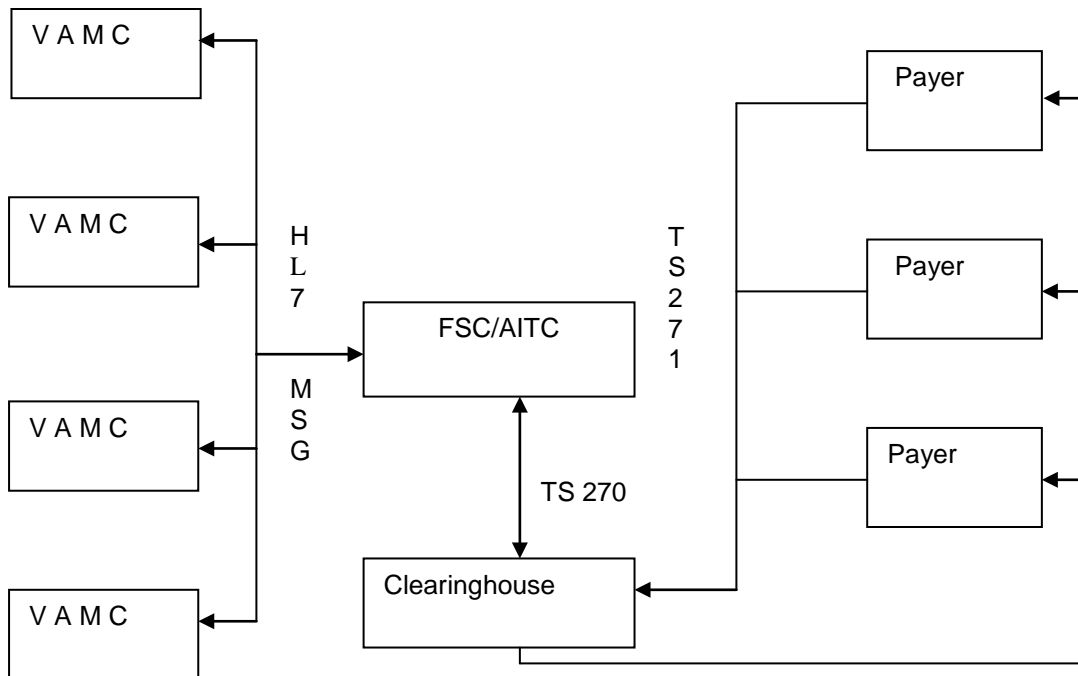

Figure 3. Flowchart of Inquiries from VistA to Payers and Responses from Payers to VistA

(This page included for two-sided copying.)

2 SITE PARAMETERS

Each VistA site can use the **eIV parameters** to configure some aspects of the eIV software in order to meet a site's unique requirements.

General Parameter	Definition
Freshness Days	How frequently should insurance information be re-verified? 7-180 Days
Daily Mailman MSG	Non Editable – The eIV statistical report is set to be sent out in an email each day (set to YES)
Daily MSG Time	Non Editable - Set to be sent at 7am (0700) local time each day.
Messages MailGroup	To which mailgroup should the eIV Statistical Report be sent?
HL7 Response Processing	Should FSC return each 270 Health Care Eligibility/Benefit Responses to the site immediately or in larger batches? Immediate or Batch
Contact Person	Who is the site's POC for eIV problems? This is the person the FSC will coordinate with if there are any problems.
Office Phone:	What is the POC's phone number?
EMAIL Address	What is the POC's email address?
Failure Mailman MSG	Send a mail message for communication failures? YES/NO

Batch - Buffer Extract	Definition
Active?	Not Editable – Buffer Extract will be turned on.

Batch – Appointment Extract	Definition
Active?	Not Editable – Appointment Extract will be turned on.
Selection Criteria #1	Not Editable – Appointment extracts will search for appointments scheduled for the next 10 days.

Batch – Non-verified Extract	Definition
Active?	Not Editable – Non-Verified Extract will be turned off.
Selection Criteria #1	Not Editable – Non-Verified Extract will be turned off.
Selection Criteria #2	Not Editable – Non-Verified Extract will be turned off.
MAXIMUM EXTRACT NUMBER	Not Editable – Non-Verified Extract will be turned off.

Batch – No Insurance Extract	Definition
Removed with Patch IB*2*416	

2.1 Define General Parameters

Step	Procedure
1	Access the SYST MCCR System Definition Menu .
2	Access the SITE MCCR Site Parameter Display/Edit option.
3	At the Select Action: prompt, enter IV for Ins. Verification .

MCCR Site Parameters		Dec 10, 2010@11:15:16	Page: 1 of 1
Display/Edit MCCR Site Parameters. Only authorized persons may edit this data.			
IB Site Parameters		Claims Tracking Parameters	
Facility Definition		General Parameters	
Mail Groups		Tracking Parameters	
Patient Billing		Random Sampling	
Third Party Billing			
Provider Id			
EDI Transmission			
Third Party Auto Billing Parameters		Insurance Verification	
General Parameters		General Parameters	
Inpatient Admission		Batch Extracts Parameters	
Outpatient Visit		Service Type Codes	
Prescription Refill			
actions			
IB Site Parameter	AB Automated Billing	EX	Exit
CT Claims Tracking	IV Ins. Verification		
Select Action: Quit//	IV Ins. Verification		

The following screen will be displayed.

```
eIV Site Parameters      Mar 25, 2011@12:55:52      Page: 1 of 1
Only authorized persons may edit this data.

Days between electronic re-verification checks: 30
Send daily statistical report via MailMan: YES
Time of day for daily statistical report: 0700
Mail Group for eIV messages: IBCNE EIV MESSAGE
HL7 Response Processing Method: IMMEDIATE
Contact Person: TESTER,IB
Send MailMan message if communication problem: YES

Extract
Name          On/Off  Selection Criteria  Maximum # to
Buffer        ON      n/a          99999
Appt         ON      10          99999





GP  General Parameters      ST  Service Type Codes      EX  Exit
Select Action: Quit//
```

Step	Procedure
4	At the Select Action: prompt, enter GP for General Parameters .

```
General Parameters

FRESHNESS DAYS: 180//

MESSAGES MAILGROUP: IBCNE EIV MESSAGE//
HL7 RESPONSE PROCESSING: Immediate//
CONTACT PERSON: IBclerk,One//
OFFICE PHONE: (777) 777-7777//
EMAIL ADDRESS: Clerk.IB@MEDVA.GOV Replace
FAILURE MAILMAN MSG: YES//
```

Step	Procedure
5	At the Freshness Days: prompt, enter a number between 7 and 180 .
	The Daily Mailman MSG prompt has been removed as it is no longer optional.
	Daily MSG Time: prompt has been removed as the system is set to automatically send the daily message at 0700 local time.
	Site can no longer turn off nor set time.
6	At the MESSAGES MAILGROUP: prompt, enter IBCNE EIV MESSAGE .
7	At the HL7 Response Processing: prompt, enter Immediate .
	<i>Patch IB*2*416 removed the prompt HL7 MAXIMUM NUMBER. A site can no</i>





Step	Procedure
	<i>longer limit the number of daily inquiries.</i>
8	At the Contact Person: prompt, enter the Name of your site's contact person.
9	At the Office Phone: prompt, enter the Number of your site's contact person.
10	At the eMail Address: prompt, enter the Email of your site's contact person.
11	At the Failure Mailman MSG: prompt, enter YES .

The user will then be returned to the eIV Site Parameters Screen.

eIV Site Parameters		Dec 10, 2010@11:21:19	Page: 1 of 1
Only authorized persons may edit this data.			
Days between electronic re-verification checks:	30		
Send daily statistical report via MailMan:	YES		
Time of day for daily statistical report:	0700		
Mail Group for eIV messages:	IBCNE EIV MESSAGE		
HL7 Response Processing Method:	IMMEDIATE		
Contact Person:	IBclerk,One		
Send MailMan message if communication problem:	YES		
Extract Name	On/Off	Selection Criteria	Maximum # to Extract/Day
Buffer	ON	n/a	99999
Appt	ON	10	99999
GP	General Parameters	ST	Service Type Codes
EX	Exit		
Select Action: Quit//			



2.2 Define Batch Extract Parameters

Patch IB*2*438 removed the ability for the sites to define Batch Extract Parameters.

	<i>Patch IB*2*416 removed the ability for sites to define Buffer and Appointment parameters. No insurance parameters were removed as no inquiries will be sent for patients w/o insurance.</i>
	<i>Patch IB*2*438 set Non-verified parameters to Not Active and Non-editable.</i>
	<i>Patch IB*2*438 updated the eIV system to no longer check for freshness days ('Days between electronic re-verification checks' defined in the MCCR site parameter) for eligibility benefit inquiries that are available in the buffer and are awaiting transmission in the transmission queue.</i>
	<i>Appointment extracts will skip policies whose last verified date is less than the freshness days from creating buffer entries.</i>

2.3 Store Default Service Type Codes

The IB system stores only Service Type Code 30 – Health Benefit Plan Coverage in the IB Site Parameters file.

Step	Procedure
1	Access the SYST MCCR System Definition Menu .
2	Access the SITE MCCR Site Parameter Display/Edit option.
3	At the Select Action: prompt, enter IV for Ins. Verification.
4	At the Select Action: prompt, enter ST for Service Type Codes.
5	Review the Service Type Codes.
	<i>Patch IB*2*438 introduced the ability to define default multiple service type codes so that inquiries could be sent for multiple Service Type Codes. Responses also included multiple Service Type Codes. (* Functionality changed with IB*2*497)</i>
	<i>Patch IB*2*497 replaces multiple user defined service type codes with a single default service type code 30.</i>

The following screen will be displayed:

```
Service Type Codes

Default Service Type Codes
30 - Health Benefit Plan

Enter ?? for more information
EX Exit
Select Action: Exit//
```

(This page included for two-sided copying.)

3 PAYERS



The VistA Payer file (#365.12) is a VA national file of insurance companies within each VistA system. It is automatically updated when a payer is enrolled and registered at the FSC by Chief Business Office (CBO). It is non-editable at the facility level and the same data exists in this file at all VistA locations. However, the VistA locations do have the option to locally activate/deactivate payers.

When a 270 Health Care Eligibility Benefits Inquiry is constructed, it is this payer name in the Payer file (#365.12), not the Insurance Company name, which is transmitted with the inquiry. In order for an individual insurance company to participate in the eIV process, it must be linked to a payer in the Payer file. It is important to note that:

- An insurance company can be linked to only one payer.
- Many insurance companies can be linked to a single payer.
- The payer must also be active locally in order for it to be eligible for inclusion in the eIV process.

3.1 Link Insurance Company to Payers using Link Insurance Company to Payers

The **Link Insurance Companies to Payers** option provides a tool for identifying potential matches of active Insurance Companies with Professional and Institutional IDs that are not linked to a particular Payer. Professional and Institutional Payer Primary ID fields correspond respectively to the EDI ID NUMBER – PROF and EDI ID NUMBER – INST fields in the Insurance Company Editor.

Step	Procedure
1	Access the PI Patient Insurance Menu .
2	Access the PM Payer Maintenance option.
	<i>Users must hold the IB INSURANCE SUPERVISOR security key to access this option.</i>
3	Access the LI Link Insurance Companies to Payers option.
	<i>The system finds potential matches for users based on matching Payer Primary ID fields in the Insurance Company Editor. Please note that all matches are not definitive and should be linked at the users discretion.</i>

The following screen of Payers who have potentially matching insurance company entries will be displayed.

```

Payer Maintenance                Sep 22, 2009@14:26:21                Page:    1 of    1
Payers with potential matches to active insurance companies.

    Payer Name                        # Potential Matches
1  IBpayer One                        2
2  IBpayer Two                        1
3  IBpayer Three                      3
4  IBpayer Four                       1

    Enter ?? for more actions
EE Expand Entry                      EX Exit
Select Action: Quit//

```

Step	Procedure
4	At the Select Action: prompt, enter EE for Expand Entry .
5	At the Select entry to Expand, by line #: (1-5): prompt, enter 2 for this example.

The following screen will be displayed.



```

Payer Expand Screen                Sep 22, 2009@14:45:22                Page:    1 of    1
PAYER: IBpayer Two                Prof. EDI#:11111  Inst. EDI#:11111

Insurance Company Name - Active Only
    Insurance Company Name          Address                                Prof#  Inst#
1  IBinsurance Two A                PO BOX 5555  SCRANTON, PA                11111  11111
2  IBinsurance Two B                PO BOX 55555  COLUMBUS OHIO                11111  11111

    Enter ?? for more actions
PL Print List                      EX Exit
LP Link Payer
Select Action: Quit//

```

Step	Procedure
6	At the Select Action: prompt, enter LP for Link Payer .
7	At the Select 1 or more Insurance Company Entries: prompt, enter 1-2 for this example.
8	At the OK to proceed? YES// prompt, press RETURN to accept the default of YES .
	<i>Patch IB*2*416 provided the ability to link more than one insurance company to a payer at one time.</i>
	<i>Users also have the option to print a list of insurance companies that may match a Payer. The list can be printed to a printer or to the screen.</i>

```
Select 1 or more Insurance Company Entries: (1-2): 1-2

You have selected 2 insurance companies
to be linked to payer IBpayer Two.
OK to proceed? YES//

      Link process is complete.
      You may view/edit this relationship by using the
      Insurance Company Entry/Edit option.

Enter RETURN to continue or '^' to exit:
```

To print the details, go back to **Expand Entry** and select **Print List** as detailed below.

Step	Procedure
1	Access the PI Patient Insurance Menu .
2	Access the PM Payer Maintenance option.
3	Access the LI Link Insurance Companies to Payers option.
4	At the Select Action: prompt, enter EE for Expand Entry .
5	At the Select entry to Expand, by line #: (1-5): prompt, enter 2 for this example.
6	At the Select Action: prompt, enter PL for Print List .
7	At the Device://Home: prompt enter RETURN to display to the screen or enter a device name.

The following screen will be displayed.

```
Payer Expand Screen          Sep 22, 2009@14:45:22          Page: 1 of 1
PAYER: IBpayer Two          Prof. EDI#:11111  Inst. EDI#:11111
Insurance Company Name - Active Only
      Insurance Company Name      Address          Prof#  Inst#
1  IBinsurance Two A             PO BOX 5555  SCRANTON, PA  11111  11111
2  IBinsurance Two B             PO BOX 555555 COLUMBUS OHIO 11111  11111

Enter RETURN to continue or '^' to exit:
```

3.2 Link Insurance Company to Payers using Insurance Company Editor

When VistA is unable for any reason to identify an insurance company as a potential match to a payer, users can link the insurance company to a payer from within the **Insurance Company Editor**.

Step	Procedure
1	Access the PI Patient Insurance Menu .
2	Access the EI Insurance Company Entry/Edit option.
3	At the Select INSURANCE COMPANY NAME: prompt, enter IBinsurance Two A for this example.

The following screen will be displayed.

```

Insurance Company Editor      Sep 22, 2009@15:11:57      Page: 1 of 9
Insurance Company Information for: IBinsurance Two A
Type of Company: HEALTH INSURANCE      Currently Active

                                Billing Parameters
Signature Required?: NO                Type Of Coverage: HEALTH INSURAN
Reimburse?: WILL REIMBURSE            Billing Phone: 555-555-5555
Mult. Bedsections: YES                 Verification Phone: 555-555-5555
One Opt. Visit: NO                     Precert Comp. Name:
Diff. Rev. Codes:                       Precert Phone: 1-800-555-5555
Amb. Sur. Rev. Code:
Rx Refill Rev. Code:
Filing Time Frame: (12 MONTH(S))

                                EDI Parameters
Transmit?: YES-LIVE                    Insurance Type: GROUP POLICY
+ Enter ?? for more actions >>>
BP Billing/EDI Param      IO Inquiry Office      EA Edit All
MM Main Mailing Address  AC Associate Companies  AI (In)Activate Company
IC Inpt Claims Office    ID Prov IDs/ID Param    CC Change Insurance Co.
OC Opt Claims Office     PA Payer                DC Delete Company
PC Prescr Claims Of     RE Remarks              VP View Plans
AO Appeals Office        SY Synonyms             EX Exit
Select Action: Next Screen// PA Payer

PAYER: IBpayer Two
  
```

Step	Procedure
4	At the Select Action: prompt, enter PA for Payer .
5	At the Payer: prompt, enter ?? to see a list of Payers.
6	At the Payer: prompt, enter IBpayer Two for this example.
	<i>To view the linked Payer for a particular insurance company, users may access VI for View Insurance Company.</i>

The following screen will be displayed.

```

Insurance Company Editor      Jul 07, 2010@13:55:50      Page:      8 of      9
Insurance Company Information for: IBinsurance Two A
Type of Company: HEALTH INSURANCE      Currently Active
+
      Payer Information: e-IV, e-Pharmacy
      Payer Name: IBpayer Two
      VA National ID: VA10      CMS National ID:
Payer Application: E-PHARM      FSC Auto-Update: NO
National Active: YES      Deactivated: NO
Local Active: YES
Payer Application: eIV      FSC Auto-Update: NO
National Active: YES      Deactivated: NO
Local Active: YES
+      Enter ?? for more actions      >>>
BP Billing/EDI Param      IO Inquiry Office      EA Edit All
MM Main Mailing Address AC Associate Companies AI (In)Activate Company
IC Inpt Claims Office ID Prov IDs/ID Param CC Change Insurance Co.
OC Opt Claims Office PA Payer DC Delete Company
PC Prescr Claims Of RE Remarks VP View Plans
AO Appeals Office SY Synonyms EX Exit
Select Action: Next Screen//

```

To view the linked payer for an insurance company, go back to the **Patient Insurance Menu** and select **View Insurance Company**.

Step	Procedure
1	Access the PI Patient Insurance Menu .
2	Access the VI View Insurance Company option.
3	At the Select INSURANCE COMPANY NAME: prompt, enter IBinsurance Two A for this example.

The following screen will be displayed.

```

Insurance Company Editor      Sep 22, 2009@15:11:57      Page:      1 of      8
Insurance Company Information for: IBinsurance Two A
Type of Company: HEALTH INSURANCE      Currently Active
      Billing Parameters
Signature Required?: NO      Type Of Coverage: HEALTH INSURAN
Reimburse?: WILL REIMBURSE      Billing Phone: 555-555-5555
Mult. Bedsections: YES      Verification Phone: 555-555-5555
One Opt. Visit: NO      Precert Comp. Name:
Diff. Rev. Codes:      Precert Phone: 1-800-555-5555
Amb. Sur. Rev. Code:
Rx Refill Rev. Code:
Filing Time Frame: (12 MONTH(S))
      EDI Parameters
Transmit?: YES-LIVE      Insurance Type: GROUP POLICY
Inst Payer Primary ID: XXXXX      Prof Payer Primary ID: XXXXX
+      Enter ?? for more actions      >>>
CC Change Insurance Co.      EX Exit
Select Action: Next Screen//

```

3.3 Payer Edit (Activate/Inactivate)

To edit the payer information users must use the **Payer Maintenance Menu**. The **Payer Edit** option is restricted to users with the **IB INSURANCE SUPERVISOR** security key.

Step	Procedure
1	Access the PI Patient Insurance Menu .
2	Access the PM Payer Maintenance Menu .
3	Access the PE Payer Edit (Activate/Inactivate) option.
4	At the Payer Name: prompt, enter IBpayer Two for this example.
	<i>Users must hold the IB INSURANCE SUPERVISOR security key to access Payer Edit.</i>

The following screen will be displayed.



```

Payer Edit

This option allows you to view the data in the Payer file for a particular
Payer. You may only edit local flags. Most of the fields in the Payer file
are not editable. This data comes into VistA electronically. If an
application has been deactivated, the local flag cannot be edited.

      Payer Name: IBpayer Two
      VA National ID: VA10
      CMS National ID:
Inst Electronic Bill ID: 11111
Prof Electronic Bill ID: 11111
      Date/Time Created: 09/23/2003@10:54:57

      Payer Application: eIV
      National Active: Active
      Future Service Days: 9999
      Past Service Days: 9999
      Auto-update Pt. Insurance: YES
      Local Active: Active//
  
```

Step	Procedure
5	At the Local Active: prompt, users can locally Activate or Deactivate a Payer. Press RETURN to accept the default for this example.
	<i>Users can only Activate/Deactivate a Payer locally. The remainder of the Payer information is set by FSC.</i>
	<i>A payer must be nationally ACTIVE and locally ACTIVE for 270/271 Health Care Eligibility Inquiry and Response messages to be transmitted.</i>
	<i>Patch IB*2*416 removed the ability for patient SSNs be transmitted as IDs in a 270 Health Care Eligibility Inquiry so those prompts were removed from Payer Edit.</i>

(This page included for two-sided copying.)

4 PROCESS INSURANCE BUFFER

The **Process Insurance Buffer** option provides four buffer views from which users may process entries and thus update patients' insurance information in the patient file:

- **Positive Insurance Buffer** – Positive 271 Health Care Eligibility Benefits Responses (that failed to meet the auto-update criteria and are non-Medicare WNR) and Manual Entries
- **Negative Insurance Buffer** - Negative 271 Health Care Eligibility Benefits Responses (non-Medicare WNR)
- **Medicare (WNR) Insurance Buffer** – Positive, Negative or Ambiguous 271 Health Care Eligibility Benefits Responses (that failed to meet the auto-update criteria and are Medicare WNR)
- **Future Appointments Buffer** – List of patients with future appointments for which the system was unable to generate 270 Health Care Eligibility Benefits Inquiries

4.1 Status Flags

4.1.1 Buffer Symbols

Flag	Meaning
(blank)	Inquiry not yet sent
+	Matching patient data was found at payer, payer indicates active policy
-	Matching patient data was found at payer, payer indicates expired policy
#	eIV is unable to determine if payer indicates active or expired policy OR matching patient data was NOT found at payer
?	Inquiry was sent, waiting for response
!	eIV was unable to send an inquiry for this entry. A manual correction is required before eIV can send inquiry. A descriptive error message will be displayed on the last screen of the expanded buffer entry.

4.1.2 Buffer Entry Status Flags

Flag	Meaning
*	This entry has been manually verified and the asterisk is not an eIV indicator.
d	Patient appears on more than one buffer view (Duplicate).

4.1.3 Patient Status Flags

Flag	Meaning
i	Patient currently has active insurance on file
I	Patient is currently admitted as an inpatient
E	Patient is deceased (expired)
Y	Patient is required to pay VA copayment for incurred charges according to Means Test
H	Patient has charges on hold

Flag	Meaning
*	Buffer entry verified by user

4.1.4 Buffer Entry Source of Information Indicators

Letter	Meaning
I	Interview
P	Pre-registration
M	Medicare
D	Data Match
E	eIV Appointment Extract
R	Insurance Capture Buffer
V	IVM
H	HMS
C	Contract Services
X	e-Pharmacy

4.1.5 Insurance Entry Update Methods

Letter	Meaning
M	Merge - Data from the buffer entry will be saved to the insurance entry ONLY if the corresponding data field in the insurance entry is blank.
O	Overwrite - ALL non-blank data in the buffer entry will be saved to the insurance entry. If a buffer entry field has a value it will be saved to the corresponding insurance entry field. Blank insurance fields will be filled and existing insurance data replaced.
R	Replace - ALL fields in the buffer entry will be saved to the insurance entry, including blank fields. Therefore all data in the insurance entry will be deleted then completely replaced by the buffer entry.
N	No Change - This option may be used to identify the Insurance entry that corresponds to a buffer entry without actually changing any of the Insurance Information. The Buffer data is ignored.
I	Individually Accept - This option may be used to accept only non-blank specific fields from the buffer entry into the Insurance entry. Only those values accepted by the user will replace the corresponding fields in the Insurance entry.

See Appendix B for a detailed list of error messages associated with entries that were created because a 270 Health Care Eligibility Benefits Inquiry could not be transmitted.

4.2 Buffer Actions

All views provide users the same actions although the **Future Appointments Buffer** has no access to 271 Health Care Eligibility Benefits Response data as this list is comprised of Appointment Extract entries that failed to create a 270 Health Care Eligibility Benefits Inquiry. These will most likely be patient policies that are not linked to

an eIV nationally activated payer. Note that patients with no insurance on file will not be included in the nightly Buffer Extract.

These following actions are available in **Process Insurance Buffer**:

- **PE** – Process Entry
- **RE** – Reject Entry
- **EE** – Expand Entry
- **AE** – Add Entry
- **ST** – Sort Entry
- **CC** – Check Ins. Co.
- **PB** – Positive Buffer
- **NB** – Negative Buffer
- **MB** – Medicare Buffer
- **FA** – Future Appointments Buffer
- **RX** – ePharm Buffer
- **EX** – Exit

These following actions are hidden, but available in Process Insurance Buffer:



- **+** – Next Screen
- **-** – Previous Screen
- **UP** – Up a Line
- **DN** – Down a Line
- **>** - Shift view to Right
- **<** - Shift view to Left
- **FS** – First Screen
- **LS** – Last Screen
- **GO** – Go to Page
- **RD** – Re Display Screen
- **PS** – Print Screen
- **PL** – Print List
- **SL** – Search List
- **ADPL** – Auto Display (On/Off)
- **QU** - Quit

4.2.1 Process Entry

Processing an entry in a **Buffer View** results in updating the patient's insurance and removing the entry from the buffer. Once users access **Process Entry**, they will have access to the following additional actions:

- **Accept Entry** - Allows users to update the patient's insurance and remove the entry from the buffer
- **Reject Entry** – Allows users to remove the entry from the buffer without updating the patient's insurance
- **Compare Entry** – Allows users to compare the data in the buffer with the data in the patient's insurance

- **Expand Entry** – Allows users to Expand an Entry – Refer to Section 4.2.3
- **Insurance Co/Patient** – Allows users to view specific information about an insurance company's available policies

Step	Procedure
1	Access the PI Patient Insurance Menu .
2	Access the BI Process Insurance Buffer option.
	<i>The default Insurance Buffer view is the Positive Insurance Buffer and users can move between views using the action for each view.</i>
	<i>Some actions such as Reject Entry are only available to users who hold the IB INSURANCE SUPERVISOR key.</i>

The following screen will be displayed.

Positive Insurance Buffer		May 21, 2010@10:18:01		Page: 1 of 1	
Sorted by: Positive Response					
Patient Name	Insurance Company	Subscr Id	S Entered	iIEYH	
1 +IBpatient,One	XXXX IBinsurance One	SUB ID XXXX	E 05/18/10	i	
2 +IBpatient,Two	XXXX IBinsurance One	SUB ID XXXX	E 05/18/10	i	
3 +IBpatient,Three	XXXX IBinsurance One	SUB ID XXXX	E 05/18/10	i	
4 +IBpatient,Four	XXXX IBinsurance Two	SUB ID XXXX	P 09/21/04	Y	
5 +IBpatient,Five	XXXX IBinsurance Four	SUB ID XXXX	P 03/31/05		
6 +IBpatient,Six	XXXX IBinsurance Four	SUB ID XXXX	P 12/08/04		
7 +IBpatient,Seven	XXXX IBinsurance Two	SUB ID XXXX	P 11/30/04	Y	
8 +IBpatient,Eight	XXXX IBinsurance Four	SUB ID XXXX	P 02/28/05	YH	
9 +IBpatient,Nine	XXXX IBinsurance Two	SUB ID XXXX	I 03/29/05	Y	
10 +IBpatient,Ten	XXXX IBinsurance Three	SUB ID XXXX	I 11/16/04		
11 +IBpatient,Eleven	XXXX IBinsurance Two	SUB ID XXXX	P 03/31/05	YH	
12 +IBpatient,Twelve	XXXX IBinsurance Five	SUB ID XXXX	I 03/24/05	H	
+ *Verified +Active ?Await/Reply					
PE Process Entry		AE Add Entry		PB Pos. Buffer FA Future Appts.	
RE Reject Entry		ST Sort List		NB Neg. Buffer EX Exit	
EE Expand Entry		CC Check Ins Co's MB Medicare Buffer			
Select Action: Next Screen//					

Step	Procedure
3	At the Select Action: prompt, enter PE for Process Entry .
4	At the Select Buffer Entry(s): (1-12): prompt, enter 1 for this example.

The following screen will be displayed.



Insurance Buffer Process		May 21, 2010@10:21:24		Page: 1 of 1	
IBpatient,One	XXX-XX-XXX	DOB: XXX XX,XXXX	AGE: XX		
IBinsurance One (P.O. BOX 555555, CLEVELAND, OH)					
- IBinsurance One	229021915	142239340	PATIEN	10/01/00	
Patient's Existing Insurance					
Insurance Company	Group #	Subscriber Id	Holder	Effective	Expires

1	IBinsurance Two	GRP NUM 11269	SUB ID XXXX	PATIEN	04/01/95	10/01/00
Any Group/Plan that may match Group Name or Group Number						
	Insurance Company		Group Name		Group Number	
2	IBinsurance Two	PO BOX 740800	XXXXXX		GRP NUM XXXX	
3	IBinsurance Two	PO BOX 740800	XXXXXX		GRP NUM XXXXX	
Enter ?? for more actions						
AE	Accept Entry	CE	Compare Entry	VP	Insurance Co/Patient	
RE	Reject Entry	EE	Expand Entry	EX	Exit	
Select Action: Quit//						

Step	Procedure
5	At the Select Action: prompt, enter AE for Accept Entry .
6	At the Select Company/Policy: (1-3): prompt, enter 1 for this example.

The following screen will be displayed.

Insurance Data:	Buffer Data	Selected Insurance Company
Company Name:	IBinsurance One	IBinsurance Two
Reimburse?:		WILL REIMBURSE
Phone Number:	1 800 555 5555	1 555 555 5555
Billing Phone:		800-555-5555
Pre-Cert Phone:		X XXX XXX XXXX
Street [Line 1]:	P.O. BOX 55555	PO BOX 555555
Street [Line 2]:		
Street [Line 3]:		
City:	CLEVELAND	ATLANTA
State:	OHIO	GEORGIA
Zip Code:	44101-4776	30374-0800
	(bold=accepted on Merge)	(bold=replaced on Overwrite)
Is this the correct INSURANCE COMPANY to match with this Buffer entry? YES		
Select the method to update the INSURANCE COMPANY: (M/O/R/N/I): N		

Step	Procedure
7	At the Is this the correct INSURANCE COMPANY to match with this Buffer entry? Prompt, enter YES .
8	At the Select the method to update the INSURANCE COMPANY: (M/O/R/N/I): prompt, always enter N .
	<i>VistA has no control over the information that the payers return, so by selecting N, the details about the payer in the VistA insurance file will not be changed.</i>
	<i>See Section 4.1.4 for details of the update methods.</i>

The following screen will be displayed.

Patient is a member of this Insurance Group/Plan		
Group/Plan Data:	Buffer Data	Selected Group/Plan
Company Name:	IBinsurance One	IBinsurance Two
Is Group Plan?:		YES
Group Name:	XXXXX	XXXXXX
Group Number:	XXXXXXXXXX	XXX XXX XXXXX
BIN:		
PCN:		
Require UR:		NO
Require Pre-Cert:		NO
Require Amb Cert:		NO
Exclude Pre-Cond:		NO
Benefits Assign:		YES
Type of Plan:		COMPREHENSIVE MAJOR MEDICAL
	(bold=accepted on merge)	(bold=replaced on overwrite)

Is this the correct GROUP/PLAN to match with this Buffer entry? YES
 Select the method to update the GROUP PLAN: (M/O/R/N/I): N

Step	Procedure
9	At the Is this the correct Group Plan to match with this Buffer entry? Prompt, enter YES .
10	At the Select the method to update the Group Plan: (M/O/R/N/I): prompt, enter N .
	<i>Vista has no control over the information that the payers return, so by selecting N the details about the payer in the Vista insurance file will not be changed.</i>

The following screen will be displayed.

Patient Name:	IBpatient,One	IBpatient,One
Last Verified:		XXX XX, XXXX
Effective Date:	XXX XX, XXXX	XXX XX, XXXX
Expiration Date:		XXX XX, XXXX
Subscriber Id:	xxxxxxxxxx	yyyyyyyyyy
Whose Insurance:	VETERAN	VETERAN
Relationship:	PATIENT	PATIENT
Name of Insured:	IBpatient,One	IBpatient,One
Insured's DOB:	XXX XX, XXXX	XXX XX, XXXX
Insured's SSN:		
Insured's SEX:		MALE
Primary Provider:		
Provider Phone:		
Coor of Benefits:		SECONDARY
Emp Sponsored?:		
Patient Id:		
Subscr Str Ln 1:		
Subscr Str Ln 2:		
Subscr City:		
Subscr State:		
Subscr Zip:		
	(bold=accepted on merge)	(bold=replaced on overwrite)

Is this the correct PATIENT POLICY to match with this Buffer entry? YES
 Select the method to update the PATIENT POLICY: (M/O/R/N/I): I

Step	Procedure
11	At the Is this the correct Patient Policy to match with this Buffer entry? Prompt, enter YES .
12	At the Select the method to update the Patient Policy: (M/O/R/N/I): prompt, enter I .
	<i>VistA has no control over the information that the payers return, so by selecting I, the user has full control over the details that are changed in the VistA insurance file.</i>

The following screen shows the prompts to **Accept, Change or Replace** entries.

```

Policy Data:  Buffer Data                Selected Policy
Company Name: IBinsurance One           | IBinsurance Two
Group #:      XXXXXXXXXX                | XXXXXX
Patient Name: IBpatient,One            | IBpatient,One
Last Verified:                               | XXX XX, XXXX
Effective Date: XXX XX, XXXX           | XXX XX, XXXX
Accept Change, Replace? No//  NO

Expiration Date:                               |
Subscriber Id: XXXXXXXXXX                | XXXXXXXXXX
Accept Change, Replace? No//  NO

Whose Insurance: VETERAN                 | VETERAN
Relationship:  PATIENT                   | PATIENT
Name of Insured: IBpatient,One          | IBpatient,One
Insured's DOB: XXX XX, XXXX             |
Accept Change, Replace? No//  NO

Insured's SSN:                               |
Primary Provider:                          |
Provider Phone:                             |
Coor of Benefits: PRIMARY                 | PRIMARY
Insured's Sex:                               | MALE
Patient Id:                                 |
Subscr Addr Ln 1:                           |
Subscr Addr Ln 2:                           |
Subscr City:                                |
Subscr State:                               |
Subscr Zip:                                 |

End of changes for POLICY related data.
Enter RETURN to continue or '^' to exit:

```

 *Eligibility/benefit data groups may be available on multiple pages. To scroll through each page, enter RETURN. To skip to the last page, enter ^.*

*** Non-editable Patient Eligibility/Benefit data from payer ***	
Payer Response	VISTA Pt. Insurance
Eligibility/Group Plan Information	
Reference ID Qualifer: OTHER	Reference ID Qualifer:
Reference ID: 123456789	Reference ID:
Reference ID description:	Reference ID description:
Reference ID Qualifer: Group Number	Provider Code:
Reference ID: AET1234	Reference ID:
Reference ID description: TEST1	Primary Diagnosis Code:
Provider Code:	Military Info Status:
Reference ID:	Employment Status:
Primary Diagnosis Code:	Government Affiliation:
Military Info Status:	Personnel Desc:
Employment Status:	Service Rank:
Government Affiliation:	Date Time Period:
Personnel Desc:	No eIV
Service Rank:	
Date Time Period:	
Eligibility/Benefit	

Eligibility/Benefit	No eIV
eIV Eligibility/Benefit Data Group# 1 of 6	
Eligibility/Benefit Information	
Elig/Ben Info: Active Coverage	
Coverage Level:	
Date/Time Qual:	
D/T Period:	
Service Type:	
Time Period:	
Insurance Type:	
Plan Coverage Desc: eIV Eligibility Determinat	
Benefit Amount:	
Benefit %:	
Quantity Qual:	
Quantity Amount:	
Auth/Certification Required:	
In-Plan-Network:	
eIV Eligibility/Benefit Data Group# 2 of 6	

After selecting the information to be changed, the following screen will be displayed.

```

STEP 1: Insurance Company
There will be NO CHANGE to the existing Insurance Company data.

STEP 2: Group/Plan
There will be NO CHANGE to the existing Group/Plan data.

STEP 3: Patient Policy
The Buffer data will INDIVIDUALLY ACCEPT (SKIP BLANKS) the existing Policy data.

STEP 4: Eligibility/Benefits
The Buffer data will replace the existing EB data.

Is this Correct, update the existing Insurance files now? Y  YES ...

Patient Policy Updated...

Warning:  Insurance Company selected already on file for this patient.
          The previous entry is active.
          The WHOSE INSURANCE are the same.
          The Effective and Expiration dates may cover overlapping dates.

There are bills On Hold for this patient.

Press 'V' to view the changes or Return to continue:
  
```

Step	Procedure
13	If you want to review the changes that were made when you chose Individually Accept, at the Press 'V' to view the changes or Return to continue: prompt, press RETURN for this example.
	<i>Note: Users may select more than one entry from the buffer at a time to process. The system will then cycle users through each selected entry.</i>

4.2.2 Reject Entry

Users can remove an entry from the Buffer by rejecting the entry.

Step	Procedure
1	At the Select Action: prompt, enter RE for Reject Entry .
2	At the Select Buffer Entry(s): (1-17): prompt, enter 12 for this example.

The following screen will be displayed.

```

-----
Entered:      9/9/09@13:46                Source:      INTERVIEW
Entered By:   IBclerk,One                 Verified:
Patient:      IBpatient,Twelve           Sub Id:      XXXXXX
Insurance:    IBinsurance Five           Group #:     XXXXX-XX
  
```

This action will delete all insurance and patient specific data from a buffer entry without first saving that data to the insurance files, leaving a stub entry for reporting purposes.

Reject this buffer entry (delete without saving to Insurance files)? N// Y

Step	Procedure
3	At the Reject this buffer entry (delete without saving to Insurance files)? N// prompt, enter YES to remove entry from the buffer.
	<i>Note: Users may select more than one entry from the buffer at a time to reject. The system will then cycle users through each entry prompting them to reject each selected entry.</i>

4.2.3 Expand Entry

Users can **Expand an Entry**. Expanding an entry will cause the following categories of information to be displayed:

- Appointment Information (**Future Appointments Buffer** view ONLY);
- Insurance Company Information;
- Group/Plan Information;
- Policy/Subscriber Information;
- Buffer Entry Information.

Step	Procedure
1	Access the BI Process Insurance Buffer .
2	At the Select Action: prompt, enter EE for Expand Entry .
3	At the Select Buffer Entry(s): (1-17): prompt, enter 1 for this example and page through the screens.

The following screens will be displayed.

Insurance Buffer Entry	Jul 23, 2013@17:16:47	Page: 1 of 4
IBDEP,ACTIVE	xxx-xx-xxxx	DOB: MAR 4,1990 AGE: 23
Buffer entry created on 07/05/13 by CLERK,IB (INTERVIEW)		

Insurance Company Information		
Name: AETNA	Reimburse?: WILL REIMBURSE	
Phone:	Billing Phone:	
	Precert Phone:	
	Remote Query From:	
Address:		
Group/Plan Information		
Group Plan?: Yes		

Group Name: TEST1
Group Number: AET1234

BIN:

Require UR: No

PCN:

Require Amb Cert: No

+-----Enter ?? for more actions-----

EI	Ins. Co. Edit	VE	Verify Entry	EB	Expand Benefits
EA	All Edit	PI	Pt. Policy Edit	EX	Exit
PE	Group/Plan Edit	RR	Response Report		

Select Action: Next Screen//

Insurance Buffer Entry Jul 23, 2013@17:19:39 Page: 2 of 4

IBDEP,ACTIVE xxx-xx-xxxxDOB: MAR 4,1990 AGE: 23
Buffer entry created on 07/05/13 by CLERK,IB (INTERVIEW)

Require Pre-Cert: No
Type of Plan: COMPREHENSIVE MAJOR MEDIC Exclude Pre-Cond: No
Benefits Assignable: Yes

Policy/Subscriber Information

Whose Insurance: SPOUSE Effective: 07/01/01
Expiration:

Insured's Name: IBINS,ACTIVE
Subscriber Id: XXXXXXXXXXXX
Relationship: SPOUSE

Primary Provider:
Provider Phone:

Insured's DOB: 03/04/90

Coord of Benefits:
Patient Id: XXXXXXXXXXXX

+-----Enter ?? for more actions-----

EI	Ins. Co. Edit	VE	Verify Entry	EB	Expand Benefits
EA	All Edit	PI	Pt. Policy Edit	EX	Exit
PE	Group/Plan Edit	RR	Response Report		

Select Action: Next Screen// NEXT SCREEN

Insurance Buffer Entry Jul 23, 2013@17:20:17 Page: 3 of 4

IBDEP,ACTIVE xxx-xx-xxxx DOB: MAR 4,1990 AGE: 23
Buffer entry created on 07/05/13 by CLERK,IB (INTERVIEW)

Employer Sponsored Group Health Plan?:

Buffer Entry Information

Date Entered: 7/5/13@09:05 Date Verified:
Entered By: CLERK,IB Verified By:

** This response is based on service date 07/05/2013 and service type: Health
Benefit Plan Cov **

eIV Trace #: xxxxxxxxxx eIV Processed Date: 7/5/13@09:38
Source: INTERVIEW

Current eIV Status: Response Received, Active Policy

Information received via electronic inquiry indicates patient has active
insurance.

```

+-----Enter ?? for more actions-----
EI  Ins. Co. Edit      VE  Verify Entry      EB  Expand Benefits
EA  All Edit          PI  Pt. Policy Edit    EX  Exit
PE  Group/Plan Edit   RR  Response Report
Select Action: Next Screen//      NEXT SCREEN

```

```

Insurance Buffer Entry      Jul 23, 2013@17:20:26      Page:      4 of      4
IBDEP,ACTIVE              xxx-xx-xxxx      DOB: MAR 4,1990      AGE: 23
      Buffer entry created on 07/05/13 by CLERK,IB (INTERVIEW)

+-----
Action to take:  Review the details listed in the eIV Response Report
before processing this buffer entry.

-----Enter ?? for more actions-----
EI  Ins. Co. Edit      VE  Verify Entry      EB  Expand Benefits
EA  All Edit          PI  Pt. Policy Edit    EX  Exit
PE  Group/Plan Edit   RR  Response Report
Select Action: Quit//

```

Once users access **Expand Entry**, they will have access to the following additional Actions:

- **Ins. Co. Edit** – Allows users to edit or change the Insurance Company
- **Edit All** – Allows users to edit each of the Expand Entry categories
- **Group/Plan Edit** - Allows users to edit the Group/Plan category
- **Verify Entry** – Allows users to Verify an entry without actually processing it out of the buffer
- **Pt. Policy Edit** – Allows users to edit the Policy/Subscriber category
- **Response Report** – Allows users to view the Response Report for this entry if the entry has an associated 271 Health Care Eligibility Benefits Response
- **Expand Benefits** – Allows users to see the Eligibility/Benefits data that was returned in the associated 271 Health Care Eligibility Benefits Response if there is one for this entry

4.2.4 Add Entry

The Add Entry action, allows users to manually add a patient to the insurance buffer.

Step	Procedure
1	At the Select Action: prompt, enter AE for Add Entry .
2	At the Select PATIENT NAME: prompt, enter IBpatient,Thirteen for this example.

The following screen will be displayed

```

Select PATIENT NAME: IBpatient,Thirteen X-X-XX      XXXXXXXXXX      YES      SC VETERAN
Enrollment Priority:                               Category: NOT ENROLLED      End Date:

Financial query queued to be sent to HEC...

      *** Patient Requires a Means Test ***

      Primary Means Test Required from APR 15,1999

Enter <RETURN> to continue.

MEANS TEST REQUIRED

```

Step	Procedure
3	Follow the prompts shown below to enter the insurance company, group/plan and policy and subscriber information.
4	When you have added an entry to the insurance buffer, you will be returned to the Positive Insurance Buffer .

```

Insurance Company: ??

Please enter the name of the insurance company that provides coverage for this
patient. This response is a free text response, however, a partial insurance
company name look-up is available here.

Insurance Company: IBinsurance
  1  IBinsurance One
  2  IBinsurance Two
  3  IBinsurance Three
  4  IBinsurance Four
  5  IBinsurance Five
CHOOSE 1-5: 2

Add a new Insurance Buffer entry for this patient and company? YES//

----- INSURANCE COMPANY INFORMATION -----

INSURANCE COMPANY NAME: IBinsurance Two//
  1  IBinsurance Two
CHOOSE 1-1: 1
REIMBURSE?:
PHONE NUMBER:
BILLING PHONE NUMBER:
PRECERTIFICATION PHONE NUMBER:
STREET ADDRESS [LINE 1]:
CITY:
STATE:
ZIP CODE:

----- GROUP/PLAN INFORMATION -----

The following data defines a specific Group or Plan provided by an Insurance
Company. This may be either a group plan with many potential members or an
individual plan with a single member.

IS THIS A GROUP POLICY?: N NO

```

GROUP NAME:
 GROUP NUMBER:
 BANKING IDENTIFICATION NUMBER:
 PROCESSOR CONTROL NUMBER (PCN):
 TYPE OF PLAN:
 UTILITIZATION REVIEW REQUIRED:
 PRECERTIFICATION REQUIRED:
 AMBULATORY CARE CERTIFICATION:
 EXCLUDE PREEEXISTING CONDITION:
 BENEFITS ASSIGNABLE:

----- POLICY AND SUBSCRIBER INFORMATION -----

The following data defines the subscriber specific policy information for a particular Insurance Plan. The subscriber, the insured, and the policy holder all refer to the person who is a member of the plan and therefore holds the policy. The patient must be covered under the plan but may not be the policy holder.

EFFECTIVE DATE:
 EXPIRATION DATE:
 PT. RELATIONSHIP TO INSURED:
 SUBSCRIBER PRIMARY ID:
 NAME OF INSURED:
 INSURED'S DOB:
 INSURED'S SEX:
 PATIENT PRIMARY ID:
 PRIMARY CARE PROVIDER:
 PRIMARY PROVIDER PHONE:
 COORDINATION OF BENEFITS:
 SOURCE OF INFORMATION: INTERVIEW//
 ESGHP?:
 SUBSCRIBER ADDRESS LINE 1:
 SUBSCRIBER ADDRESS LINE 2:
 SUBSCRIBER ADDRESS CITY:
 SUBSCRIBER ADDRESS STATE:
 SUBSCRIBER ADDRESS ZIP:

4.2.5 Sort Buffer Views

The default sort for all Buffer views (except the **Positive Insurance Buffer**) is alphabetically by patient name. The **Positive Insurance Buffer** is sorted by Positive Responses first and then alphabetically by patient name.

Users may re-sort the buffer based upon the following criteria:

- Insurance Company
- Source of Information
- Date Entered
- Inpatients
- Means Test
- On Hold
- Verified
- eIV Status

4.2.6 Check Insurance Company

Users may view a list of insurance companies that exist in the insurance buffer that do not match any of the insurance company names or synonyms in the insurance company file. These insurance companies do not match any entries in the IIV AUTO MATCH file.



Once users select the **Check Ins Co's** action, they will have access to the following actions (Refer to Section 7 Auto Match):

- Select Entry
- Auto Match Enter/Edit

Step	Procedure
1	Access the BI Process Insurance Buffer .
2	At the Select Action: prompt, enter CC for Check Ins Co's .

The following screen will be displayed.

Unmatched Buffer Names	Jul 07, 2010@12:02:54	Page: 1 of 1
These are Insurance Company names from the Insurance Buffer file that do not exist in the Insurance Company file (either as Names or as Synonyms). They also do not exist or pattern match with any entry in the Auto Match file.		
1	IBinsurance One	
2	IBinsurance Twu	
3	IBinsurance Three	
4	IBinsurance Four	
5	IBinsurance Five	
6	IBinsurance Six	
7	IBinsurance Seven	
8	IBinsurance Eight	
9	IBinsurance Nine	
10	IBinsurance Ten	
Enter ?? for more actions		
Select Entry	Auto Match Enter/Edit	Exit
Select Action: Next Screen//		

Step	Procedure
	<i>Each buffer entry that fails to make any match to an entry in the Insurance Company file (#36) or the IIV AUTO MATCH file (#365.11) is presented to the user.</i>
	<i>This example sets up an auto match entry to associate IBinsurance Twu with IBinsurance Two.</i>
3	At the Select Action: prompt, enter SE for Select Entry .
4	At the Select Entry: (1-192): prompt select 2 for IBinsurance Twu .
5	At the Select INSURANCE COMPANY NAME: prompt enter IBinsurance Two .

The following screen will be displayed.

Select	INSURANCE COMPANY NAME: IBinsurance Two					
1	IBinsurance Two	SAMPLE RD	NEWARK	OHIO	Y	
2	IBinsurance Two	TEST RD	LIVONIA	MICHIGAN	**	
3	IBinsurance Two	PO BOX 5555	MIDDLETOWN	NEW YORK	**	
CHOOSE 1-3:	1	IBinsurance Two	SAMPLE RD	NEWARK	OHIO	Y

Step	Procedure
6	At the CHOOSE 1-3: prompt in this example, enter 1 for IBinsurance Two SAMPLE RD.
7	At the Do you want to add an Auto Match entry that associates IBinsurance Twu with IBinsurance Two? No//: prompt, enter YES.

The following prompts are displayed along with a confirmation message.

Do you want to add an Auto Match entry that associates IBinsurance Twu with IBinsurance Two? No// Y YES
 AUTO MATCH VALUE: IBinsurance Twu //
 IBinsurance Twu is now associated with IBinsurance Two.

4.2.7 Positive View/Negative View/Medicare View/Appointment View

Users may switch back and forth between the different available **Buffer Views** by selecting one of the following actions:

- **PB** – Pos. Buffer
- **NB** – Neg. Buffer
- **MB** – Medicare Buffer
- **FA** – Future Appts. Buffer

4.2.8 AAA Errors – - Negative Buffer View, Response Report

Users may view the Error Reporting Codes and corresponding textual descriptions in the Response Report when an Error Reporting Code is received in response to an associated 270 Health Care Eligibility Benefits entry.

Step	Procedure
1	Access the BI Process Insurance Buffer.
2	At the Select Action: prompt, enter NB for Negative Buffer view.
3	At the Select Action: prompt, enter EE to expand an entry that has a “#”.
4	Note any AAA error messages listed in the Buffer entry.
5	You can see the same AAA error messages on the associated response report by enter RR to review the associated eIV Response Report..

The AAA errors are displayed as shown in the following sample Response Report when accessed from within the Process Insurance Buffer option:

```
eIV Response Report by Trace #                               May 07, 2013@11:48:22 Page:1
                                     Trace #: XXXXXXXXXXXX

Subscriber: IBSUB,AAAERROR
Subscriber ID:
Subscriber DOB: 02/11/1947
Subscriber SSN:
Group Name:
Group ID:
Subscriber Sex: M
Whose Insurance: VETERAN                                     PATIENT
Member ID:
COB:
Service Date:
Date of Death:
Effective Date:
Certification Date:
Expiration Date:
Payer Updated Policy:
Response Date: 05/02/2013                                     Trace #: XXXXXXXXXXXX

ERROR INFORMATION:

Reject Reason Code: 72
Reject Reason Text: Invalid/Missing Subscriber/Insured ID
Action Code: Invalid/Missing Subscriber/Insured ID
HIPAA Loop: Please Correct and Resubmit
HL7 Location: N/A
Error Source: Subscriber Name

*** END OF REPORT ***
```

The AAA errors listed will be identical whether displayed on the Expand Entry screen within the Insurance Buffer, the Response Report called from within the Insurance Buffer and the Response Report called from the eIV Menu.

```
eIV Response Report

Insurance verification responses are received daily.
Please select a date range in which responses were received to view the
associated response detail. Otherwise, select a Trace # to view specific
response detail.
Select one of the following:
1 Report by Date Range
2 Report by Trace #
Select the type of report to generate: 1// 2 Report by Trace #
Enter Trace # for report:
Enter Trace # for report: XXXXXXXXXXXXXXXXXXXX xxxxxx,xxxxxxx CIGNA
...OK? Yes// y (Yes)

DEVICE: HOME// Linux Telnet/SSH

Compiling report data ...
```

The AAA errors are displayed as shown in the following sample Response Report when accessed from the eIV Menu:

```

eIV Response Report by Trace #                               May 07, 2013@11:48:22 Page:1
                                                           Trace #: XXXXXXXXXX

  Payer: CIGNA
Patient: IBSUB,AAAERROR (SSN: xxx-xx-xxxx  DOB: 02/11/1947)

  Subscriber: IBSUB,AAAERROR
  Subscriber ID:
  Subscriber DOB: 02/11/1947
  Subscriber SSN:                                           Subscriber Sex: M
  Group Name:
  Group ID:
Whose Insurance: VETERAN                                     PATIENT
  Member ID:                                               COB:
  Service Date:                                           Date of Death:
  Effective Date:                                         Certification Date:
  Expiration Date:                                       Payer Updated Policy:
  Response Date: 05/02/2013                               Trace #: XXXXXXXXXX

ERROR INFORMATION:

Reject Reason Code: 72
Reject Reason Text: Invalid/Missing Subscriber/Insured ID
Action Code:      Invalid/Missing Subscriber/Insured ID
HIPAA Loop:      Please Correct and Resubmit
HL7 Location:    N/A
Error Source:    Subscriber Name
  
```

4.3 Medicare Potential Insurance Worklist - Potential COB Report

Users may create a worklist of those patients Medicare has identified in a 271 HL7 response message as having insurance subsequent to their Medicare insurance.

Step	Procedure
1	Access the Integrated Billing Master Menu
2	Select the Patient Insurance Menu
3	Select the eIV MENU
4	Select the Medicare Potential COB List option
5	Accept all default answers to the prompts for Earliest Report Date, Latest Report Date and Sort by.
6	Select either "Screen List" or "Report" for the format type.
	<i>This is new for patch IB*2*497</i>

4.3.1 Search Criteria - Potential COB Worklist

Users may search for patients whom Medicare has identified in a 271 HL7 response message as having insurance subsequent to their Medicare insurance based on the following:

- Earliest Date 271 HL7 message received
- Latest Date 271 HL7 message received

4.3.2 Sort Criteria – Potential COB Worklist

Users may sort entries for patients whom Medicare has identified as having insurance subsequent to their Medicare insurance:

- Chronological Order
- Reverse Chronological Order

4.3.3 Format – Potential COB Worklist

Users may select one of the following formats for the list of patients whom Medicare has identified as having insurance subsequent to their Medicare insurance:

- Report (refer to report section for more details)
- ListManager

4.3.4 Screen ListManager for Completed Entries – Potential COB Worklist

The ListManager view of patients whom Medicare has identified as having insurance subsequent to their Medicare insurance does not display completed entries.

4.3.5 ListManager – Potential COB Worklist

Users may perform the following actions from within the list of patients whom Medicare has identified as having insurance subsequent to their Medicare insurance:

- Mark entry as Not Reviewed
- Mark entry as Review in Process
- Mark entry as Review Complete
- Enter Comments
- View Comments

4.3.6 Comments – Potential COB Worklist

The system captures the following information when users enter comments to an entry on the list of patients whom Medicare has identified as having insurance subsequent to their Medicare Insurance:

- User Name
- Date
- Time

4.3.7 Visual Indicators – Potential COB Worklist

The system provides visual indicators for entries on the list of patients whom Medicare has identified as having insurance subsequent to their Medicare insurance for the following conditions:



- Entries as Not Reviewed
- Entries marked as Review in Process
- Entries marked as Review Complete (can only be seen on the report format)
- Entries the system thinks, based on exact match of insurance company name and address, already exist in the Patient's Insurance.

(This page included for two-sided copying.)

5 REQUEST ELECTRONIC INSURANCE INQUIRY

This option allows users to create a 270 Health Care Eligibility Benefits Inquiry whenever needed. This option allows users to override the re-verification of Service Date of today and individually select a specific Service Type Code. If no code is selected the default of Service Type Code 30 as set in the IB Site Parameters is used. Using this option to create a buffer entry will by-pass the auto-update feature, leaving the buffer entry for manual processing.

5.1 Request a 270 Health Care + Benefits Inquiry

Step	Procedure
	<i>This example will send an insurance inquiry for Service Code Type 87 (cancer). If Service Type Code is defaulted then an inquiry will be sent for the Service Type Code defined in section 2.3 Define Service Code Parameters</i>
1	Access the PI Patient Insurance Menu .
2	Access the eIV Menu .
3	Access the EI Request Electronic Insurance Inquiry option.
4	At the Select Patient Name prompt, enter Patient Name (in this example IBpatient,One)
	<i>Users must hold the IBCNE IIV SUPERVISOR security key to access this option.</i>
	<i>Patch IB*2*438 provided the ability to request insurance inquiries with specific Service Type Codes. Patch IB*2*497 removed the ability to request multiple Service Type Codes but does allow for the selection of a single Service Type Code.</i>

The following screen will be displayed.

```
eIV Insurance Request          Dec 22, 2010@16:53:22          Page: 1 of 1
Request Electronic Insurance Inquiry for Patient: IB,PATIENT C I2222

Insurance Co.   Type of Policy   Group           Holder          Effect.         Expires
1   Insurance Comp1   TST1223        OTHER          07/01/2001
2   Insurance Comp2   GRP NUM 20     SELF          04/09/2010

Enter ?? for more actions                                     >>>
SE Select Entry                                           EX Exit
Select Action: Quit// SE   Select Entry
Select entry to request electronic inquiry: (1-2): 1

Enter Service Type Code: ?

Answer with X12 271 SERVICE TYPE CODE
Do you want the entire 187-Entry X12 271 SERVICE TYPE List? N
Enter Service Type Code: ??

Enter the single SERVICE TYPE CODE to be sent with inquiry or press 'ENTER' to
send DEFAULT Service Type Code 30 (Health Benefit Plan Coverage).

No response generated by this option will auto-update the patient file.

Enter Service Type Code: ?
```

```

Answer with X12 271 SERVICE TYPE CODE
Do you want the entire 187-Entry X12 271 SERVICE TYPE List? Y (Yes)
Choose from:
1      Medical Care
2      Surgical
3      Consultation
4      Diagnostic X-Ray
5      Diagnostic Lab
6      Radiation Therapy
7      Anesthesia
8      Surgical Assistance
9      Other Medical
10     Blood Charges
11     Used DME
12     DME Purchase
13     Ambulatory SC Facility
14     Renal Supplies/Home
15     Alt. Method Dialysis
16     CRD Equipment
17     Pre-Admission Testing
18     DME Rental
19     Pneumonia Vaccine
20     2nd Surgical Opinion
'^' TO STOP:

Enter Service Type Code: 11      Used DME

Are you sure you want to request an insurance inquiry? NO// Y YES

Insurance Buffer entry created!

Enter RETURN to continue or '^' to exit:

```

Step	Procedure
5	At the Select Action prompt, enter SE Select Entry.
6	At the Select entry to request electronic inquiry: (1-2): prompt, enter 1 for this example.
7	At the SERVICE TYPE CODE prompt, enter ? for a list of the Service Type Codes or enter the one required. In this example enter 11 . Now select yes and the Insurance Buffer entry will be created
	<i>Note: An asterisk (*) will indicate that the request already has a buffer entry.</i>

(This page included for two-sided copying.)

6 PATIENT INSURANCE INFO VIEW/EDIT

The Patient Insurance Info View/Edit option is used to look at a patient's insurance information and edit that data, if necessary. The system groups information that is specific to the insurance company, specific to the patient, specific to the group plan, specific to the annual benefits available, and the annual benefits already used.

Once a patient is selected, this screen is displayed listing all the patient's insurance policies. Information provided for each policy may include type of policy, group name, holder, effective date, and expiration date.

6.1 View Patient Policy Information

This screen displays expanded policy information for the selected company. Categories include utilization review data, subscriber data, subscriber's employer information, effective dates, plan coverage limitations, last contact, and comments on the patient policy or insurance group plan.

Step	Procedure
1	Access the PI Patient Insurance Menu .
2	Access the PI Patient Insurance Info View/Edit Option
3	At the Select Patient Name prompt, enter Patient Name .

The following screen will be displayed

Patient Insurance Management Jul 21, 2010@13:23:59		Page: 1 of 1				
Insurance Management for Patient: IBpatient,One 1234						
	Insurance Co.	Type of Policy	Group	Holder	Effect.	Expires
1	IBinsurance One	COMPREHENSIVE M	GRP NUM 13	SELF	06/20/09	
Enter ?? for more actions						>>>
AP	Add Policy	EA	Fast Edit All	CP	Change Patient	
VP	Policy Edit/View	BU	Benefits Used	WP	Worksheet Print	
DP	Delete Policy	VC	Verify Coverage	PC	Print Insurance Cov.	
AB	Annual Benefits	RI	Personal Riders	EB	Expand Benefits	
EX	Exit					
Select Item(s): Quit//						

Step	Procedure
4	At the Select Action prompt, enter VP for Policy Edit/View.

The following series of screens will be displayed

Select Patient Insurance Menu <TEST ACCOUNT> Option: PI Patient Insurance Info View/Edit

Select PATIENT NAME: IBSUB,AC,ACTIVE A IBSUB,ACTIVE A 2-2-22
XXXXXXXXXX NO NSC VETERAN
Enrollment Priority: GROUP 8c Category: ENROLLED End Date:

```

Patient Insurance Management Jul 22, 2013@11:51:39 Page: 1 of 1
Insurance Management for Patient: IBSUB,ACTIVE A I8542
*** Patient has Insurance Buffer Records
----Insurance Co.----Type of Policy---Group-----Holder---Effect.----Expires--
1 AETNA COMPREHENSIVE M GRP NUM 13 SPOUSE 01/01/13

-----Enter ?? for more actions----->>>
AP Add Policy EA Fast Edit All CP Change Patient
VP Policy Edit/View BU Benefits Used WP Worksheet Print
DP Delete Policy VC Verify Coverage PC Print Insurance Cov.
AB Annual Benefits RI Personal Riders EB Expand Benefits
RX RX COB Determination EX Exit
Select Item(s): Quit// VP Policy Edit/View .....

```

```

Patient Policy Information Jul 22, 2013@11:51:43 Page: 1 of 9
Expanded Policy Information for: IBSUB,ACTIVE A XXX-XX-XXXX
AETNA Insurance Company ** Plan Currently Active **
-----
Insurance Company
Company: AETNA
Street: PO BOX 981106
City/State: EL PASO, TX 79998
Billing Ph: 1-888-632-3862
Precert Ph: XXXXXXXXXX6

Plan Information
Is Group Plan: YES
Group Name: GRP NUM 13805
Group Number: GRP NUM 13805
BIN:
+-----Enter ?? for more actions----->>>
PI Change Plan Info IC Insur. Contact Inf. CP Change Policy Plan
UI UR Info EM Employer Info VC Verify Coverage
ED Effective Dates CV Add/Edit Coverage AB Annual Benefits
SU Subscriber Update AC Add Comment BU Benefits Used
IP Inactivate Plan EA Fast Edit All EB Expand Benefits

```

EX Exit
Select Action: Next Screen// NEXT SCREEN

Patient Policy Information Jul 22, 2013@11:51:49 Page: 2 of 9
Expanded Policy Information for: IBSUB,ACTIVE A XXX-XX-XXXX
AETNA Insurance Company ** Plan Currently Active **

+-----+
PCN:
Type of Plan: COMPREHENSIVE MAJOR MED
Plan Filing TF: (3 YEAR(S))
ePharmacy Plan ID:
ePharmacy Plan Name:
ePharmacy Natl Status:
ePharmacy Local Status:

Utilization Review Info Effective Dates & Source
Require UR: NO Effective Date: 01/01/13
Require Amb Cert: NO Expiration Date:

+-----Enter ?? for more actions-----+
PI Change Plan Info IC Insur. Contact Inf. CP Change Policy Plan
UI UR Info EM Employer Info VC Verify Coverage
ED Effective Dates CV Add/Edit Coverage AB Annual Benefits
SU Subscriber Update AC Add Comment BU Benefits Used
IP Inactivate Plan EA Fast Edit All EB Expand Benefits
EX Exit
Select Action: Next Screen// NEXT SCREEN

Patient Policy Information Jul 22, 2013@11:51:51 Page: 3 of 9
Expanded Policy Information for: IBSUB,ACTIVE A XXX-XX-XXXX
AETNA Insurance Company ** Plan Currently Active **

+-----+
Require Pre-Cert: YES Source of Info:
Exclude Pre-Cond: NO Policy Not Billable: NO
Benefits Assignable: YES

Subscriber Information
Whose Insurance: SPOUSE
Subscriber Name: IBSUB,ACTIVEX
Relationship: SPOUSE
Primary ID: 111111AE
Coord. Benefits: PRIMARY

+-----Enter ?? for more actions-----+
PI Change Plan Info IC Insur. Contact Inf. CP Change Policy Plan
UI UR Info EM Employer Info VC Verify Coverage
ED Effective Dates CV Add/Edit Coverage AB Annual Benefits
SU Subscriber Update AC Add Comment BU Benefits Used
IP Inactivate Plan EA Fast Edit All EB Expand Benefits
EX Exit
Select Action: Next Screen// NEXT SCREEN

+-----

Subscriber's Employer Information

Employment Status: Emp Sponsored Plan: No
Employer: Claims to Employer: No, Send to

Insurance

Street: Retirement Date:
City/State:
Phone:

Primary Provider:
Prim Prov Phone:

Insured Person's Information (use Subscriber Update Action)

+-----Enter ?? for more actions-----

PI	Change Plan Info	IC	Insur. Contact Inf.	CP	Change Policy Plan
UI	UR Info	EM	Employer Info	VC	Verify Coverage
ED	Effective Dates	CV	Add/Edit Coverage	AB	Annual Benefits
SU	Subscriber Update	AC	Add Comment	BU	Benefits Used
IP	Inactivate Plan	EA	Fast Edit All	EB	Expand Benefits

EX Exit

Select Action: Next Screen// NEXT SCREEN

+-----

Insured's DOB: 02/02/1922
Str 1: PALMER HOUSE HEALTH CARE
Str 2: SHEARER ST
City: PALMER
St/Zip: MA 01069
SubDiv:
Country: USA
Phone:

Insured's Sex: MALE
Insured's Branch: ARMY
Insured's Rank:

+-----Enter ?? for more actions-----

PI	Change Plan Info	IC	Insur. Contact Inf.	CP	Change Policy Plan
UI	UR Info	EM	Employer Info	VC	Verify Coverage
ED	Effective Dates	CV	Add/Edit Coverage	AB	Annual Benefits
SU	Subscriber Update	AC	Add Comment	BU	Benefits Used
IP	Inactivate Plan	EA	Fast Edit All	EB	Expand Benefits

EX Exit

Select Action: Next Screen// NEXT SCREEN

Insurance Company ID Numbers (use Subscriber Update Action)
 Subscriber ID: XXXXXXXX

Patient Primary ID: XXXXXXXX

Plan Coverage Limitations

Coverage	Effective Date	Covered?	Limit	Comments
INPATIENT	01/01/2007	YES		

+-----Enter ?? for more actions-----

PI Change Plan Info	IC Insur. Contact Inf.	CP Change Policy Plan
UI UR Info	EM Employer Info	VC Verify Coverage
ED Effective Dates	CV Add/Edit Coverage	AB Annual Benefits
SU Subscriber Update	AC Add Comment	BU Benefits Used
IP Inactivate Plan	EA Fast Edit All	EB Expand Benefits
EX Exit		

Select Action: Next Screen// NEXT SCREEN

OUTPATIENT	01/01/2007	YES
PHARMACY	01/01/2007	NO
DENTAL	01/01/2007	NO
MENTAL HEALTH	01/01/2007	YES
LONG TERM CARE	01/01/2007	NO

User Information

Entered By: CLERK,IB
 Entered On: 06/05/13
 Last Verified By:
 Last Verified On:

Insurance Contact (last)

Person Contacted:
 Method of Contact:
 Contact's Phone:
 Call Ref. No.:

+-----Enter ?? for more actions-----

PI Change Plan Info	IC Insur. Contact Inf.	CP Change Policy Plan
UI UR Info	EM Employer Info	VC Verify Coverage
ED Effective Dates	CV Add/Edit Coverage	AB Annual Benefits
SU Subscriber Update	AC Add Comment	BU Benefits Used
IP Inactivate Plan	EA Fast Edit All	EB Expand Benefits
EX Exit		

Select Action: Next Screen// NEXT SCREEN

Patient Policy Information Jul 22, 2013@11:52:11 Page: 8 of 9
Expanded Policy Information for: IBSUB,ACTIVE A XXX-XX-XXXX
AETNA Insurance Company ** Plan Currently Active **

Last Updated By: Contact Date:
Last Updated On:

Comment -- Patient Policy
None

Comment -- Group Plan
DME = Y

Personal Riders

+-----Enter ?? for more actions-----
PI Change Plan Info IC Insur. Contact Inf. CP Change Policy Plan
UI UR Info EM Employer Info VC Verify Coverage
ED Effective Dates CV Add/Edit Coverage AB Annual Benefits
SU Subscriber Update AC Add Comment BU Benefits Used
IP Inactivate Plan EA Fast Edit All EB Expand Benefits
EX Exit
Select Action: Next Screen// NEXT SCREEN

Patient Policy Information Jul 22, 2013@11:52:14 Page: 9 of 9
Expanded Policy Information for: IBSUB,ACTIVE A XXX-XX-XXXX
AETNA Insurance Company ** Plan Currently Active **

-----Enter ?? for more actions-----
PI Change Plan Info IC Insur. Contact Inf. CP Change Policy Plan
UI UR Info EM Employer Info VC Verify Coverage
ED Effective Dates CV Add/Edit Coverage AB Annual Benefits
SU Subscriber Update AC Add Comment BU Benefits Used
IP Inactivate Plan EA Fast Edit All EB Expand Benefits
EX Exit
Select Action: Quit//

6.2 View Eligibility Benefit Information

This screen allows eligibility / benefit information to be displayed.

Step	Procedure
1	Access the PI Patient Insurance Menu .
2	Access the PI Patient Insurance Info View/Edit Option
3	At the Select Patient Name prompt, enter Patient Name (in this example IBpatient,One).
4	At the Select Action prompt, enter EB for Expand Benefits .

The following screen will be displayed

```
eIV Elig/Benefit Information Jul 23, 2013@17:41:07 Page: 1 of 11
IBDEP,ACTIVE xxx-xx-xxxx AETNA
** This response is based on service date 07/05/2013 and service type: Health
Benefit Plan Cov **
-----
Eligibility/Group Plan Information
Reference ID Qualifer: OTHER Reference ID: 123456789
Reference ID description:
Reference ID Qualifer: Group Number Reference ID: AET1234
Reference ID description: TEST1

Provider Code:
Reference ID:

Primary Diagnosis Code:

Military Info Status: Employment Status:
Government Affiliation: Personnel Desc:
Service Rank: Date Time Period:

eIV Eligibility/Benefit Data Group# 1 of 6
+-----Enter ?? for more actions-----
EX Exit
Select Action: Next Screen// NEXT SCREEN
```

```
eIV Elig/Benefit Information Jul 23, 2013@17:41:10 Page: 2 of 11
IBDEP,ACTIVE xxx-xx-xxxx AETNA
** This response is based on service date 07/05/2013 and service type: Health
Benefit Plan Cov **
-----
Eligibility/Benefit Information
Elig/Ben Info: Active Coverage Coverage Level:
Date/Time Qual: D/T Period:
```

(This page included for two-sided copying.)

7 IIV AUTO MATCH PAYERS

Auto Match is a VistA feature designed to help match user-entered insurance company names to the correct payers in the database. In VistA, there are several places a user can enter an insurance company name (free text) without a list of valid insurance names from which to pick. Patient registration and the insurance buffer are two examples. This can result in misspelled, improperly formatted or incomplete insurance company names. Auto Match is necessary because the eIV software must be able to identify which insurance company the user is referring to in order to appropriately generate inquiries and process responses. This functionality promotes the use of consistent insurance company names.

There is an IIV AUTO MATCH file (#365.11) in each VistA system. Each record in the file has two fields. The first field, **Entered Name**, stores the insurance company name that the user entered into the VistA system without validation. The second field, **Proper Name**, stores the name of the insurance company that can be found in the insurance file of the VistA database.

The Auto Match feature is used to teach the VistA system how to interpret common misspellings or incomplete entries that users enter when typing in free text insurance company names.

It is recommended that users run the **Check Ins Co's** action on names from the **Insurance Buffer Views** to initially populate the Auto Match files based on existing entries in the **Insurance Buffer**. Selecting this action will generate a list of insurance company names found in the current insurance buffer file that do not exist in the Insurance Company file (#36). The more one "teaches" the IIV AUTO MATCH file the fewer problems eIV will encounter when it creates insurance inquiries for electronic transmission to the payers.

There is also a menu option, **Enter/Edit Auto Match Entries** that allows users to maintain Auto Match entries. It is described in section 6.2.2.

Users must have the IBCNE IIV AUTO MATCH security key to add, update, or delete an Auto Match entry.

7.1 Auto Match in VistA Applications

Auto Match is currently used in the **Insurance Buffer**.

When a user types in a free text insurance company name, VistA attempts to match the name with one of the insurance company names currently stored in the insurance file. If that attempt fails, the name is compared to the list of **Entered Name(s)** in the IIV AUTO MATCH file (#365.11). If there are **Entered Name(s)** that match it, they are displayed along with their associated **Proper Name(s)**. Users may then select one of the valid names to replace the free text entry.

Users are not required to accept one of the supplied choices. Users are allowed to keep the free text name. The Auto Match process may fail to find a matching insurance company name(s). In this case, no choices are presented to users.

7.2 Types of Auto Match Matches



7.2.1 Simple Auto Match Matches

In a simple Auto Match, the **Entered Name** field literally contains the name found in the insurance buffer. Leading and trailing spaces are ignored. An entry in this form might have **BC/BS** as the **Entered Name** and show **IBinsurance BC/BS** in the **Proper Name** field. As the insurance staff encounter misnamed insurance companies (i.e. the name on the insurance card does not match the name in the VistA database), users can correct the name and VistA will prompt users to add it as a new record in the IIV AUTO MATCH file (#365.11).

7.2.2 Wildcard Auto Match Matches

In a wildcard Auto Match, simple matches are supported but now the wildcard character, the asterisk (*), can be utilized. Wildcards may be used to anticipate common spelling mistakes. The asterisk can be substituted for any number of characters. For example, if users enter BC*BS, the system will return all Insurance Company names that begin with BC and end with BS. BC/BS, BC BS, BC-BS, BCBS and BC / BS would all match BC*BS.

An Entered Name may contain more than one asterisk (i.e. BC*BS*). When a wildcard is used, a minimum of four non-wildcard characters must be specified as well.

Step	Procedure
1	Access the eIV Menu .
2	Access the AE Enter/Edit Auto Match Entries option.
3	At the Select an Auto Match Entry prompt, enter IBinsurance Number Two for this example.
4	At the Are you adding 'IBinsurance Number Two' as a new eIV AUTO MATCH (the 144th)? No// prompt, enter YES to override the default of NO.
5	At the eIV Auto Match Insurance Company Name: prompt, enter IBinsurance Two for this example.
	<i>Remember – the Entered Name must be a minimum of 3 characters and an “*” must be used with four additional characters.</i>
	<i>Entered Names must be unique. One Entered Name cannot be associated with more than one Insurance Company Name.</i>
	<i>Users must have the IBCNE IIV AUTO MATCH security key to add, update, or delete an Auto Match entry.</i>

```

Enter/Edit Insurance Company Name Auto Match Entries

This option will allow you to enter, edit, and manage the entries in the
Insurance Company Auto Match file. This file will aid in the proper selection
of Insurance Companies by associating together a valid, correct Insurance
Company name with an incorrect entry that a clerk may enter during data entry.

Select an Auto Match Entry: IBinsurance Number Two

For your information, no insurance company names or synonyms passed
a pattern match on 'IBinsurance Number Two'.

Are you adding 'IBinsurance Number Two' as a new eIV AUTO MATCH (the 144TH)? No// Y
(Yes)
eIV AUTO MATCH INSURANCE COMPANY NAME: IBinsurance Two

IBinsurance Number Two is now associated with IBinsurance Two.

```

7.3 Maintain the Auto Match Entries

VistA offers a separate menu option to create, update, and delete IIV AUTO MATCH file (#365.11) entries.

The auto match file has several fields, of which only the **Entered Name** and **Proper Name** are editable:

- The Entered Name which may be a simple company name or a wildcard pattern. In either case, it is this name that is matched to the name entered into the insurance buffer by a user.
- The Proper Name which identifies an insurance company by its name in the insurance files.



Step	Procedure
1	Access the eIV Menu .
2	Access the AB Add Auto Match Entries Using Insurance Buffer Data option.

The following screen will be displayed.

Unmatched Buffer Names Jul 07, 2010@12:02:54 Page: 1 of 1
 These are Insurance Company names from the Insurance Buffer file that do not exist in the Insurance Company file (either as Names or as Synonyms). They also do not exist or pattern match with any entry in the Auto Match file.

- 1 IBinsurance One
- 2 IBinsurance Number Two
- 3 IBinsurance Three
- 4 IBinsurance Four
- 5 IBinsurance Five
- 6 IBinsurance Six
- 7 IBinsurance Seven
- 8 IBinsurance Eight
- 9 IBinsurance Nine
- 10 IBinsurance Ten

Enter ?? for more actions
 Select Entry Auto Match Enter/Edit Exit
 Select Action: Next Screen//

Step	Procedure
3	At the Select Action prompt, enter Auto Match Enter/Edit for this example.
4	Access the AE Enter/Edit Auto Match Entries option.
5	At the Select an Auto Match Entry prompt, enter IBinsurance Number Two for this example.
6	At the Are you adding 'IBinsurance Number Two' as a new eIV AUTO MATCH (the 144th)? No// prompt, enter YES
7	At the eIV Auto Match Insurance Company Name: prompt, enter IBinsurance Two for this example.
	<i>Remember – the Entered Name must be a minimum of 3 characters and an “*” must be used with four additional characters.</i>
	<i>Entered Names must be unique. One Entered Name cannot be associated with more than one Insurance Company Name.</i>

7.4 Check Insurance Buffer Company Names

As described in section 4.2.6, the action **Check Ins Co's.** in the **Insurance Buffer** screen is another method of accessing the **Auto Match Enter/Edit** option.

Step	Procedure
1	Access the PI Patient Insurance Menu.
2	Access the BI Process Insurance Buffer option.

The following screen will be displayed.

Positive Insurance Buffer		May 21, 2010@10:18:01		Page: 1 of 1	
Sorted by: Positive Response					
	Patient Name	Insurance Company	Subscr Id	S Entered	iIEYH
1	+IBpatient,One	XXXX IBinsurance One	SUB ID XXXX	E 05/18/10	i
2	+IBpatient,Two	XXXX IBinsurance One	SUB ID XXXX	E 05/18/10	i
3	+IBpatient,Three	XXXX IBinsurance One	SUB ID XXXX	E 05/18/10	i
4	+IBpatient,Four	XXXX IBinsurance Two	SUB ID XXXX	P 09/21/04	Y
5	+IBpatient,Five	XXXX IBinsurance Four	SUB ID XXXX	P 03/31/05	
6	+IBpatient,Six	XXXX IBinsurance Four	SUB ID XXXX	P 12/08/04	
7	+IBpatient,Seven	XXXX IBinsurance Two	SUB ID XXXX	P 11/30/04	Y
8	+IBpatient,Eight	XXXX IBinsurance Four	SUB ID XXXX	P 02/28/05	YH
9	+IBpatient,Nine	XXXX IBinsurance Two	SUB ID XXXX	I 03/29/05	Y
10	+IBpatient,Ten	XXXX IBinsurance Three	SUB ID XXXX	I 11/16/04	
11	+IBpatient,Eleven	XXXX IBinsurance Two	SUB ID XXXX	P 03/31/05	YH
12	+IBpatient,Twelve	XXXX IBinsurance Five	SUB ID XXXX	I 03/24/05	H

*Verified +Active ?Await/Reply

PE Process Entry AE Add Entry PB Pos. Buffer FA Future Appts.
RE Reject Entry ST Sort List NB Neg. Buffer EX Exit
EE Expand Entry CC Check Ins Co's MB Medicare Buffer

Select Action: Next Screen//

Step	Procedure
3	At the Select Action: prompt, enter CC for Check Ins Co's .

The following screen will be displayed.

Unmatched Buffer Names		Jul 07, 2010@12:02:54		Page: 1 of 1	
These are Insurance Company names from the Insurance Buffer file that do not exist in the Insurance Company file (either as Names or as Synonyms). They also do not exist or pattern match with any entry in the Auto Match file.					
1	IBinsurance One				
2	IBinsurance Number Two				
3	IBinsurance Three				
4	IBinsurance Four				
5	IBinsurance Five				
6	IBinsurance Six				
7	IBinsurance Seven				
8	IBinsurance Eight				
9	IBinsurance Nine				
10	IBinsurance Ten				



Enter ?? for more actions

Select Entry Auto Match Enter/Edit Exit

Select Action: Next Screen//

7.5 Change Company Name via the Insurance Buffer

Auto Match entries can also be created when users change an **Insurance Buffer** entry's insurance company name in the insurance buffer edit screen. When users changes the existing insurance company name, listed on an **Insurance Buffer** entry, VistA prompts users to keep track of the original typed name and new name as an Auto Match entry. If users concur, the original typed insurance company name is treated as the **Entered Name** and the new insurance company name is considered the **Proper Name**. The user is then offered the opportunity to modify the **Entered Name**, possibly to make it more general.

Step	Procedure
	<i>This example sets up an auto match entry to associate IBinsurance Flur with IBinsurance Four.</i>
1	Access the PI Patient Insurance Menu .
2	Access the BI Process Insurance Buffer option.
	<i>VistA warns users when the Proper Name matches an insurance company's name synonym and not the company's name, or the Proper Name matches more than one synonym and company name.</i>

The following screen will be displayed.

Positive Insurance Buffer		May 21, 2010@10:18:01		Page: 1 of 1	
Sorted by: Positive Response					
	Patient Name	Insurance Company	Subscr Id	S Entered	iIEYH
1	+IBpatient,One	XXXX IBinsurance One	SUB ID XXXX	E 05/18/10	i
2	+IBpatient,Two	XXXX IBinsurance One	SUB ID XXXX	E 05/18/10	i
3	+IBpatient,Three	XXXX IBinsurance One	SUB ID XXXX	E 05/18/10	i
4	+IBpatient,Four	XXXX IBinsurance Two	SUB ID XXXX	P 09/21/04	Y
5	+IBpatient,Five	XXXX IBinsurance Four	SUB ID XXXX	P 03/31/05	
6	+IBpatient,Six	XXXX IBinsurance Flur	SUB ID XXXX	P 12/08/04	
7	+IBpatient,Seven	XXXX IBinsurance Two	SUB ID XXXX	P 11/30/04	Y
8	+IBpatient,Eight	XXXX IBinsurance Four	SUB ID XXXX	P 02/28/05	YH
9	+IBpatient,Nine	XXXX IBinsurance Two	SUB ID XXXX	I 03/29/05	Y
10	+IBpatient,Ten	XXXX IBinsurance Three	SUB ID XXXX	I 11/16/04	
11	+IBpatient,Eleven	XXXX IBinsurance Two	SUB ID XXXX	P 03/31/05	YH
12	+IBpatient,Twelve	XXXX IBinsurance Five	SUB ID XXXX	I 03/24/05	H

*Verified +Active ?Await/Reply

PE Process Entry AE Add Entry PB Pos. Buffer FA Future Appts.

RE Reject Entry ST Sort List NB Neg. Buffer EX Exit

EE Expand Entry CC Check Ins Co's MB Medicare Buffer

Select Action: Exit//

Step	Procedure
3	At the Select Action: prompt, enter EE for Expand Entry .
4	At the Select Buffer Entries: prompt, enter 6 for this example and page through the screens.

The following screens will be displayed.

Insurance Buffer Entry Jul 23, 2013@17:16:47 Page: 1 of 4
IBDEP,ACTIVE xxx-xx-xxxxx DOB: MAR 4,1990 AGE: 23
Buffer entry created on 07/05/13 by CLERK,IB (INTERVIEW)

Insurance Company Information

Name: AETNA Reimburse?: WILL REIMBURSE
Phone: Billing Phone:
Precert Phone:
Remote Query From:
Address:

Group/Plan Information

Group Plan?: Yes
Group Name: TEST1
Group Number: AET1234
BIN: Require UR: No
PCN: Require Amb Cert: No

+-----Enter ?? for more actions-----

EI Ins. Co. Edit VE Verify Entry EB Expand Benefits
EA All Edit PI Pt. Policy Edit EX Exit
PE Group/Plan Edit RR Response Report
Select Action: Next Screen//

```

Insurance Buffer Entry      Jul 23, 2013@17:19:39      Page:      2 of      4
IBDEP,ACTIVE              xxx-xx-xxxx      DOB: MAR 4,1990      AGE: 23
      Buffer entry created on 07/05/13 by CLERK,IB (INTERVIEW)
-----
                                Require Pre-Cert: No
Type of Plan: COMPREHENSIVE MAJOR MEDIC      Exclude Pre-Cond: No
                                                Benefits Assignable: Yes

                                Policy/Subscriber Information
Whose Insurance: SPOUSE      Effective: 07/01/01
                                                Expiration:

Insured's Name: IBINS,ACTIVE
Subscriber Id: XXXXXXXXXXXX
Relationship: SPOUSE      Primary Provider:
                                                Provider Phone:

Insured's DOB: 03/04/90      Coord of Benefits:
                                                Patient Id: XXXXXXXXXXXX

+-----Enter ?? for more actions-----
EI  Ins. Co. Edit      VE  Verify Entry      EB  Expand Benefits
EA  All Edit      PI  Pt. Policy Edit      EX  Exit
PE  Group/Plan Edit      RR  Response Report
Select Action: Next Screen//      NEXT SCREEN

```

```

Insurance Buffer Entry      Jul 23, 2013@17:20:17      Page:      3 of      4
IBDEP,ACTIVE              xxx-xx-xxxx      DOB: MAR 4,1990      AGE: 23
      Buffer entry created on 07/05/13 by CLERK,IB (INTERVIEW)
-----
Employer Sponsored Group Health Plan?:

                                Buffer Entry Information
Date Entered: 7/5/13@09:05      Date Verified:
Entered By: CLERK,IB      Verified By:
** This response is based on service date 07/05/2013 and service type: Health
Benefit Plan Cov **
eIV Trace #: xxxxxxxxx      eIV Processed Date: 7/5/13@09:38
Source: INTERVIEW
Current eIV Status: Response Received, Active Policy

Information received via electronic inquiry indicates patient has active
insurance.

+-----Enter ?? for more actions-----
EI  Ins. Co. Edit      VE  Verify Entry      EB  Expand Benefits
EA  All Edit      PI  Pt. Policy Edit      EX  Exit
PE  Group/Plan Edit      RR  Response Report
Select Action: Next Screen//      NEXT SCREEN

```

```

Insurance Buffer Entry      Jul 23, 2013@17:20:26      Page:      4 of      4
IBDEP,ACTIVE              xxx-xx-xxxx      DOB: MAR 4,1990      AGE: 23

```

Buffer entry created on 07/05/13 by CLERK,IB (INTERVIEW)

+-----
Action to take: Review the details listed in the eIV Response Report before processing this buffer entry.

-----Enter ?? for more actions-----
EI Ins. Co. Edit VE Verify Entry EB Expand Benefits
EA All Edit PI Pt. Policy Edit EX Exit
PE Group/Plan Edit RR Response Report
Select Action: Quit//

Step	Procedure
3	At the Select Action: prompt, enter EI for Ins. Co. Edit.
4	At the Insurance Company Name: IBinsurance Flur // prompt, enter IBinsurance Four.
5	At the CHOOSE 1-5: prompt, enter 1 for this example.
6	At the Do you want to add an Auto Match entry that associates IBinsurance Flur with IBinsurance Four? No// prompt, enter YES.

The following prompts are displayed along with a confirmation message.

```
----- INSURANCE COMPANY INFORMATION -----  
  
INSURANCE COMPANY NAME: IBinsurance Flur // IBinsurance Four  
1 IBinsurance Four  
2 IBinsurance Four A  
3 IBinsurance Four B  
4 IBinsurance Four C  
CHOOSE 1-5: 1  
  
Do you want to add an Auto Match entry that associates  
IBinsurance Flur with IBinsurance Four? No// Y YES  
  
AUTO MATCH VALUE: IBinsurance Flur //  
  
IBinsurance Flur is now associated with IBinsurance Four.
```

Step	Procedure
7	There will then be a series of prompts to update the insurance company details. At each prompt, enter RETURN to keep the current setting.

```

REIMBURSE?:
PHONE NUMBER: 8005555555//
BILLING PHONE NUMBER:
PRECERTIFICATION PHONE NUMBER:
STREET ADDRESS [LINE 1]: PO BOX 55555//
STREET ADDRESS [LINE 2]:
CITY: CLEVELAND//
STATE: OHIO//
ZIP CODE: 44101//

```

Step	Procedure
8	After accepting all the current insurance company settings the original insurance buffer entry will be displayed showing the revised insurance company.

```

Insurance Buffer Entry      Jul 23, 2013@17:16:47      Page:      1 of      4
IBDEP,ACTIVE              xxx-xx-xxxx      DOB: MAR 4,1990      AGE: 23
      Buffer entry created on 07/05/13 by CLERK,IB (INTERVIEW)

-----

                        Insurance Company Information
Name: AETNA                      Reimburse?: WILL REIMBURSE
Phone:                          Billing Phone:
                                Precert Phone:
                                Remote Query From:
Address:

                        Group/Plan Information
Group Plan?: Yes
Group Name: TEST1
Group Number: AET1234
      BIN:                      Require UR: No
      PCN:                      Require Amb Cert: No
+-----Enter ?? for more actions-----
EI  Ins. Co. Edit      VE  Verify Entry      EB  Expand Benefits
EA  All Edit          PI  Pt. Policy Edit    EX  Exit
PE  Group/Plan Edit   RR  Response Report
Select Action: Next Screen//

```

```

Insurance Buffer Entry      Jul 23, 2013@17:19:39      Page:      2 of      4
IBDEP,ACTIVE              xxx-xx-xxxx      DOB: MAR 4,1990      AGE: 23
      Buffer entry created on 07/05/13 by CLERK,IB (INTERVIEW)

-----

                        Require Pre-Cert: No

```

Type of Plan: COMPREHENSIVE MAJOR MEDIC Exclude Pre-Cond: No
Benefits Assignable: Yes

Policy/Subscriber Information

Whose Insurance: SPOUSE Effective: 07/01/01
Expiration:
Insured's Name: IBINS,ACTIVE
Subscriber Id: XXXXXXXXXXXX
Relationship: SPOUSE Primary Provider:
Provider Phone:
Insured's DOB: 03/04/90 Coord of Benefits:
Patient Id: XXXXXXXXXXXX

+-----Enter ?? for more actions-----
EI Ins. Co. Edit VE Verify Entry EB Expand Benefits
EA All Edit PI Pt. Policy Edit EX Exit
PE Group/Plan Edit RR Response Report
Select Action: Next Screen// NEXT SCREEN

Insurance Buffer Entry Jul 23, 2013@17:20:17 Page: 3 of 4
IBDEP,ACTIVE xxx-xx-xxxx DOB: MAR 4,1990 AGE: 23
Buffer entry created on 07/05/13 by CLERK,IB (INTERVIEW)

+-----
Employer Sponsored Group Health Plan?:

Buffer Entry Information

Date Entered: 7/5/13@09:05 Date Verified:
Entered By: CLERK,IB Verified By:
** This response is based on service date 07/05/2013 and service type: Health
Benefit Plan Cov **
eIV Trace #: xxxxxxxxx eIV Processed Date: 7/5/13@09:38
Source: INTERVIEW
Current eIV Status: Response Received, Active Policy

Information received via electronic inquiry indicates patient has active insurance.

+-----Enter ?? for more actions-----
EI Ins. Co. Edit VE Verify Entry EB Expand Benefits
EA All Edit PI Pt. Policy Edit EX Exit
PE Group/Plan Edit RR Response Report
Select Action: Next Screen// NEXT SCREEN

Insurance Buffer Entry Jul 23, 2013@17:20:26 Page: 4 of 4
IBDEP,ACTIVE xxx-xx-xxxx DOB: MAR 4,1990 AGE: 23
Buffer entry created on 07/05/13 by CLERK,IB (INTERVIEW)

+-----
Action to take: Review the details listed in the eIV Response Report
before processing this buffer entry.

-----Enter ?? for more actions-----
EI Ins. Co. Edit VE Verify Entry EB Expand Benefits
EA All Edit PI Pt. Policy Edit EX Exit
PE Group/Plan Edit RR Response Report
Select Action: Quit//

(This page included for two-sided copying.)

8 eIV REPORTS

There are multiple eIV-related reports. An explanation of and instructions for each report are described in this section.

The first six eIV Reports can be found on the **eIV Menu** on the **Patient Insurance Menu**.

AB	Add Auto Match Entries Using Insurance Buffer Data
AE	Enter/Edit Auto Match Entries
EI	Request Electronic Insurance Inquiry
IU	eIV Patient Insurance Update Report
LR	eIV Payer Link Report
MW	Medicare Potential COB Worklist
NI	Potential New Insurance Found ...
PR	eIV Payer Report
RR	eIV Response Report
SR	eIV Statistical Report

Select eIV Menu Option:

The remaining two eIV Reports can be found under the **Potential New Insurance Found** option on the **eIV Menu**.

AR	eIV Ambiguous Policy Report
IR	eIV Inactive Policy Report

Select Potential New Insurance Found Option:

8.1 eIV Patient Insurance Update Report

Purpose of this Report

This report is used to view the list of patients whose Patient Insurance Information has been either not updated or updated in one of the following manners:

- Automatic updates based on a 271 Response message
- Processing via the **Insurance Buffer** option

Report Parameters

Search Criteria:

- Summary or Detail
- All or Selected Payers
- Response Received Date Range
- All or Selected Patients

Sort Criteria:

- Payer Name
- Patient Name
- Clerk Name

This is a 132 column report.

Sample Report

Patient Name	SSN	Dt Rec'd	Payer	Ck AB	Clerk/Auto	Verified	Days
Pt. Insurance Update Report							
Sorted by: Payer Name							
Detailed Report: All Patients; All Payers							
Jun 03, 2010@10:35:41 Page:1							
05/04/2010 - 06/03/2010							

Count = 12							
IBinsurance One				Y	Not Processed	N/A	22
IBpatient,One	XXXX	05/12/2010	IBinsurance One	Y	Not Processed	N/A	22
IBpatient,Two	XXXX	05/12/2010	IBinsurance One	Y	Not Processed	N/A	22
IBpatient,One	XXXX	05/12/2010	IBinsurance One	Y	Not Processed	N/A	22
IBpatient,Two	XXXX	05/12/2010	IBinsurance One	Y	xxxxxxx,xxxxxxx	05/06/2010	22
IBpatient,One	XXXX	05/13/2010	IBinsurance One	Y	Not Processed	N/A	21
IBpatient,Two	XXXX	05/13/2010	IBinsurance One	Y	Not Processed	N/A	21
IBpatient,One	XXXX	05/14/2010	IBinsurance One	Y	Not Processed	N/A	20
IBpatient,Two	XXXX	05/14/2010	IBinsurance One	Y	Not Processed	N/A	20
IBpatient,Two	XXXX	05/17/2010	IBinsurance One	Y	Not Processed	N/A	17
IBpatient,One	XXXX	05/17/2010	IBinsurance One	Y	Not Processed	N/A	17
IBpatient,Two	XXXX	05/18/2010	IBinsurance One	Y	Not Processed	N/A	16
IBpatient,One	XXXX	05/18/2010	IBinsurance One	Y	Not Processed	N/A	16
Count = 7							
IBinsurance Two				Y	xxxxxxx,xxxxxxx	05/18/2010	22
IBpatient,Three	XXXX	05/12/2010	IBinsurance Two	Y	xxxxxxx,xxxxxxx	05/18/2010	22
Enter RETURN to continue or '^' to exit:							

8.2 eIV Response Report

Purpose of this Report

This report is used to view the data that was received through the eIV process – receipt of 271 Health Care Eligibility Benefits Response messages.

Report Parameters

Search Criteria:

- Response Received Date Range
- Trace #
- All or Selected Payers
- All or Selected Patients
- All Responses or Most Recent (for a payer/patient combination)

Sort Criteria:

- Payer or Patient

Sample Report

eIV Response Report
Insurance verification responses are received daily. Please select a date range in which responses were received to view the associated response detail. Otherwise, select a Trace # to view specific response detail.
Select one of the following:
1 Report by Date Range
2 Report by Trace #
Select the type of report to generate: 1// Report by Date Range
Start DATE: T-1 (JUL 09, 2013)
End DATE: T (JUL 10, 2013)
Payer or <Return> for All Payers:
Patient or <Return> for All Patients:

Select one of the following:

- A All Responses
- M Most Recent Responses

Select the type of responses to display: A// ll Responses

Select one of the following:

- 1 Payer Name
- 2 Patient Name

Select the primary sort field: 1// Payer Name

DEVICE: HOME// 0;80;999 Linux Telnet/SSH

Compiling report data ...

eIV Response Report Jul 10, 2013@12:08:38 Page: 1
Sorted by: Payer Name Responses Displayed: All
07/09/2013 - 07/10/2013
All Payers
All Patients

Payer: AETNA
Patient: IBINS,ACTIVE (SSN: xxx-xx-xxxx DOB: 07/26/1941)

Subscriber: IBINS,ACTIVE
Subscriber ID: XXXXXXXXXXXX
Subscriber DOB: 03/04/1990
Subscriber SSN: Subscriber Sex:
Group Name: TEST1
Group ID: AET1234
Whose Insurance: 01
Member ID: COB:
Service Date: Date of Death:
Effective Date: 07/01/2001 Certification Date:
Expiration Date: Payer Updated Policy:
Response Date: 07/09/2013 Trace #: 165772400
Policy Number:

Subscriber Dates:

Discharge: 20010801
Issue: 20010715
COBRA Begin: 20010501
COBRA End: 20010531

Patient Dates:

Plan Begin: 20010701

*** END OF REPORT ***

Below is an example of the error information generated by the Payer or FSC displayed in the Response Report.

```
eIV Response Report by Trace #           May 07, 2013@11:48:22  Page:1
                                     Trace #: XXXXXXXXXX

Payer: CIGNA
Patient: IBSUB,AAAERROR (SSN: xxx-xx-xxxx  DOB: 02/11/1947)

Subscriber: IBSUB,AAAERROR
Subscriber ID:
Subscriber DOB: 02/11/1947
Subscriber SSN:                               Subscriber Sex: M
Group Name:
Group ID:
Whose Insurance: VETERAN                       PATIENT
Member ID:                                     COB:
Service Date:                                 Date of Death:
Effective Date:                               Certification Date:
Expiration Date:                             Payer Updated Policy:
Response Date: 05/02/2013                    Trace #: XXXXXXXXXX

ERROR INFORMATION:

Reject Reason Code: 72
Reject Reason Text: Invalid/Missing Subscriber/Insured ID
Action Code:   Invalid/Missing Subscriber/Insured ID
HIPAA Loop:   Please Correct and Resubmit
HL7 Location: N/A
Error Source: Subscriber Name
```

The Error Source shows the originator of the returned error. “P” = Payer, “F” = FSC.

8.3 eIV Payer Report

Purpose of this Report

This report is used to monitor the communication between VistA and the payers, including the types of error and warning messages that are received by VistA from the different payers.

Report Parameters

Search Criteria:

- Inquiry Made Date Range
- All or Selected Payers
- Include Rejection Detail (Yes/No)
- All Responses or Most Recent (for a payer/patient combination)

Sort Criteria:

- Payer Name
- Total Inquiries

This is a 132 column report.

Sample Report

eIV Payer Report		05/04/2010 - 06/03/2010										Jun 03, 2010@10:39:21 Page: 1	
Sorted by: Payer		All Payers										Rejection Detail: Not Included	
Payer [Inactive Date]	Created	Cancel	Queued	***** SENT *****	1st Att	Retry	*** RECEIVED ***	Good	Error	AvgResp (Days)	Timeout	Pending	
IBpayer One	12	0	0	12	0	12	0	0.00	0	0	0		
IBpayer Two	6	0	0	6	1	7	0	0.00	0	0	0		
IBpayer Three	12	0	0	12	0	11	1	0.00	0	0	0		
IBpayer Four	37	0	0	37	3	28	5	0.00	3	5	5		
Grand Totals	67	0	0	67	4	58	6	0.00	3	5	5		

*** END OF REPORT ***

Enter RETURN to continue or '^' to exit:

8.4 Medicare Potential Insurance Worklist - Potential COB Worklist/Report

Purpose of this Report

This report is used to create a list of those patients whom Medicare has identified in a 271 HL7 response message as having insurance subsequent to their Medicare insurance with the following data extracted from the 271 HL7 message when available:

- Patient Name
- Payer Code (primary, secondary, tertiary)
- Name of Insurance Company
- Insurance Company ID
- Review Status (not reviewed, review in process, completed)
- Insurance Company Address
- Insurance Company Phone Number
- Insurance Company Web Address

Report Parameters

Search Criteria:

- Earliest Date 271 HL7 message received
- Latest Date 271 HL7 message received

Sort Criteria

- Chronological Order
- Reverse Chronological Order

Report Format:

- Report
- Screen List (for additional details including screenshot, see in Section 4.3)

Report Type:

- COMPLETED entries ONLY

- COMPLETED entries ONLY with comments
- Exclude COMPLETED entries
- Exclude COMPLETED entries with comments

8.4.1 Medicare Potential COB – as a Worklist

User comments are not shown in the Worklist version of the Medicare Potential COB display.

The EE – Expand Entry action is available in **Medicare Potential COB Worklist**.

These following actions are hidden, but available in Medicare Potential COB Worklist:

- + – Next Screen
- - – Previous Screen
- UP – Up a Line
- DN – Down a Line
- > - Shift view to Right
- < - Shift view to Left
- FS – First Screen
- LS – Last Screen
- GO – Go to Page
- RD – Re Display Screen
- PS – Print Screen
- PL – Print List
- SL – Search List
- ADPL – Auto Display (On/Off)
- QU - Quit

Several indicators may be found on the main screen of the worklist:

- Stat – Status of the eIV Response Record. A “Y” means that the review of the response has been started by someone.
- Following the insurance company name:
 - P – the eIV response indicates that the insurance company is the primary insurance
 - S – eIV response indicates that the insurance company is the secondary insurance
 - T – eIV response indicates that the insurance company is the tertiary insurance

Sample Medicare Potential COB Worklist

Medicare Potential COB List	Dec 10, 2013@13:47:22	Page:	1 of	1
Sorted in Chronological Order.				
---Resp Rcv--Subscriber-----DOB-----Stat-INS COMPANY-----				
03/14/13				

```

1          IB,PATIENT A SR  0150P 01/01/50  Y   INSURANCE COMPANY ONE (P)
                                                INSURANCE COMPANY TWO

-----*Exact Match-----
EE  Expand Entry
Select Action: Quit// EE

```

Once an entry is selected and expanded by using the EE – Expand Entry action, additional actions are available to the user.

Sample Medicare Potential COB Worklist – Expanded Entry

```

Medicare Potential COB List  Jan 06, 2014@07:16:26      Page:    1 of    1
Patient: IB,PATIENT A SR                                In Process
Code  Payer
-----
P      INSURANCE COMPANY ONE

      111 MAIN STREET
      HOUSTON, TX 999991111
      Phone: 1112223333
      Website: www.INSURANCECOMPANYONE.com

      INSURANCE COMPANY TWO

      222 MAIN STREET
      DALLAS, TX 888882222
      Phone: 4445556666
      Website: www.INSURANCECOMPANYTWO.com

Comments:

      No Comments Entered.
      *Exact Match
CS  Change Status          AC  Add Comments
Select Action: Quit//

```

The CS – Change Status action is used to change the status of the record.

The AC – Add Comments action is used to enter comments.

8.4.2 Medicare Potential COB – as a Report

The information displayed on the Medicare Potential COB directly depends on which “Report Type” was selected. The header of the report reflects the selected date range and Report Type.

Sample Medicare Potential COB Report

Pt. Secondary Insurance Report Jul 23, 2013@18:02:01 Page: 1
Sort: Chronological Order 06/23/2013 - 07/23/2013
Includes Completed Entries

IB,PATIENT 03/09/1935 Review Status: Complete

INSURANCE COMPANY ONE.,
111 MAIN STREET
HOUSTON, TX 999991111
Phone: 1112223333
Website: www.INSURANCECOMPANYONE.com

IB,PATIENT 03/09/1935 2

INSURANCE COMPANY TWO, 222 MAIN STREET
HOUSTON, TX 999991111
Phone: 1112223333
Website: www.INSURANCECOMPANYTWO.com

IB,PATIENT 03/09/1935 2

INSURANCE COMPANY THREE,
333 MAIN STREET
HOUSTON, TX 999991111
Phone: 1112223333
Website: www.INSURANCECOMPANYTHREE.com

*** END OF REPORT ***

8.5 eIV Statistical Report

Purpose of this Report

This report is used to monitor the eIV process including statistics based on outgoing inquiries, incoming responses, pending responses and queued inquiries, etc.

This report should be monitored on a daily basis as it provides users the ability to detect eIV communication problems with the FSC in addition to potential problems in the configuration of the **eIV Site Parameters**. It also provides users with a quick view of new eIV associated payers and a summary of the insurance buffer entries.

This report is distributed daily as a MailMan message to the members of the mail group that is defined in the **IB Site Parameters**. The MailMan version covers the most recent 24 hours and is based on the default report parameters. The MailMan message is only sent when enabled through the **IB Site Parameters**.

Report Parameters

Search Criteria:

- Response Received Date Range
- Trace #

- All or Selected Payers
- All or Selected Patients
- All Responses or Most Recent (for a payer/patient combination)

Sample Report

eIV Statistical Report	Jun 29, 2009@10:46:41	Page: 1
	Report Timeframe:	
	11/07/2007 05:00 - 06/29/2009 05:00	
Outgoing Data		
=====		
Inquiries Sent:	0	
Insurance Buffer		0
Appointment		0
Non-verified Insurance		0
Incoming Data		
=====		
Responses Received:	0	
Insurance Buffer		0
Appointment		0
Non-verified Insurance		0
Current Status		
=====		
Responses Pending:	1	
Queued Inquiries:	0	
Deferred Inquiries:	0	
Insurance Companies w/o National ID:	891	
eIV Payers Disabled Locally:	0	
Insurance Buffer Entries:	11	
User Action Required:		11
# of * entries (User Verified policy)		4
# of + entries (Payer indicated Active policy)		1
# of - entries (Payer indicated Inactive policy)		1
# of # entries (Policy status undetermined)		0
# of ! entries (eIV needs user assistance for entry)		5
Entries Awaiting Processing:		0
# of ? entries (IIV is waiting for a response)		0
# of blank entries (yet to be processed or accepted)		0
Current Status		
=====		
New eIV Payers received during report date range:		
No new Payers added		
National Payers - ACTIVE flag changes at FSC		
=====		
IBpayer One	Message Dt: 09/06/09	Set: ON
IBpayer Three	Message Dt: 09/11/09	Set: OFF
IBpayer Four	Message Dt: 09/14/09	Set: OFF
IBpayer Five	Message Dt: 09/05/09	Set: ON
Nationally Active Payers - TRUSTED flag changes at FSC		
=====		
IBpayer Two	Message Dt: 09/12/09	Set: ON
IBpayer Six	Message Dt: 09/10/07	Set: OFF

8.6 eIV Payer Link Report

Purpose of this Report

To be eligible for electronic insurance eligibility communications via the eIV software, participating Insurance Companies must be linked to a payer from the National EDI Payer list.

This report provides information based on the relationship that the users set up in Vista between the insurance companies and the payers. This report can assist with finding insurance companies that are linked to the wrong payer. Also, the report can assist with identifying unlinked insurance companies or payers. Additionally, this report will indicate the payer locally active status.

Report Parameters

Search Criteria:

- Payer List or Insurance Company List
- All or Selected Payers
- All or Linked or Unlinked Payers
- Linked Detail or Summary

Sort Criteria:

- Payer Name
- VA National Payer ID
- Nationally Enabled Status
- Locally Enabled Status
- # of Linked Insurance Companies

This is a 132 column report.

Sample Report – Payer Link

eIV Payer Link Report		All Payers, With Ins. Co. Detail				Jun 03, 2010@10:47:25 Page:1	
Report Option: Payer List		National	# Linked	Nationally	Locally	Prof.	Inst.
Payer Name:		Payer ID	Ins. Co.	Active?	Active?	EDI#	EDI#

--							
IBpayer One	VA529	0	YES	YES			
IBpayer Two	VA1	81	YES	YES	23222		23222
Linked Insurance Companies:							
IBinsurance Two	PO BOX 26190		GREENSBORO, NC		60054		60054
IBinsurance Two	PO BOX 30167		TAMPA, FL		60054		60054
IBinsurance Two A	PO BOX 937		TOLEDO, OH		60054		60054
IBinsurance Two B	PO BOX 150409		HARTFORD, CT		60054		60054
IBinsurance Two C	PO BOX 795080		SAN ANTONIO, TX		60054		60054
IBinsurance Two D	PO BOX 91555		ARLINGTON, TX		60054		60054
IBinsurance Two E	PO BOX 91544		ARLINGTON, TX		60054		60054
IBinsurance Two F	PO BOX 7012		DOVER, DE		60054		60054
IBinsurance Two G	PO BOX 981107		EL PASO, TX		60054		60054
IBinsurance Two H	THIRD PARTY CLAIMS M		MEMPHIS, TN		60054		60054
IBinsurance Two J	PO BOX 35890		LOUISVILLE, KY		60054		60054
IBinsurance Two K	PO BOX 1725		PEORIA, IL		60054		60054

Enter RETURN to continue or '^' to exit:

Sample Report – Insurance Company List

eIV Payer Link Report		All Insurance Companies				Jun 03, 2010@10:49:56 Page: 7	
Report Option: Insurance Company List							
Insurance Company:		Nat. Act?	Loc. Act?	Prof. EDI#	Inst. EDI#		
Payer:	VA ID						

IBinsurance One							
35 SAMPLE RD. MT VERNON, OH 43050							
** NOT CURRENTLY LINKED **							
IBinsurance Two A							
PO BOX 55555 GREENSBORO, NC 27402							
IBpayer Two	VA1	YES	YES	23222	60054	60054	
IBinsurance Two B							
PO BOX 55555 TAMPA, FL 33630							
IBpayer Two	VA1	YES	YES	23222	60054	60054	
IBinsurance Four							
PO BOX 555 TOLEDO, OH 43695							
Enter RETURN to continue or '^' to exit:							

8.7 MailMan Summaries

VistA automatically produces a daily MailMan message with a copy of the eIV Statistical Report summarizing the eIV activity for the preceding 24 hours. This mail message will be sent to those in the pre-determined mail group that is designated in the general parameters section of the **IB Site Parameter**.

Sample - eIV Statistical Report in MailMan Message

Subj: ** eIV Statistical Rpt ** [#13300889] 2 Jul 04 13:01 39 lines		
From: INSURANCE IDENTIFICATION & VERIFICATION In 'IN' basket. Page 1 *New*		

IIV Statistical Report	Jul 2, 2004@13:00:42 Page: 1	
	Report Timeframe:	
	07/01/2004 13:00 - 07/02/2004 13:00	
Outgoing Data		
=====		
Inquiries Sent:	68	
Insurance Buffer		10
Appointment (Pre-Registration)		15
Non-verified Insurance		23
Incoming Data		
=====		
Responses Received:	60	
Insurance Buffer		10
Appointment (Pre-Registration)		14
Non-verified Insurance		22
Current Status		
=====		
Responses Pending:	8	
Queued Inquiries:	57	
Deferred Inquiries:	0	
Insurance Companies w/o National ID:	1292	
eIV Payers Disabled Locally:	0	
Insurance Buffer Entries:	235	
User Action Required:		215

```

# of * entries (User Verified policy)                19
# of + entries (Payer indicated Active policy)       24
# of - entries (Payer indicated Inactive policy)     7
# of # entries (Policy status undetermined)         39
# of ! entries (IIV needs user assistance for entry) 126
Entries Awaiting Processing:                20
# of ? entries (IIV is waiting for a response)      16
# of blank entries (yet to be processed or accepted) 4

Current Status
=====

New eIV Payers received during report date range:
Please link the associated active insurance companies to these payers at your
earliest convenience.  Locally activate the payers after you link insurance
companies to them.  For further details regarding this process, please refer
to the Integrated Billing IIV Interface User Guide.

      IBpayer One
      IBpayer Three

National Payers - ACTIVE flag changes at FSC
=====
IBpayer Two                Message Dt: 09/06/09 Set: ON
IBpayer Four              Message Dt: 09/11/09 Set: OFF
IBpayer Six               Message Dt: 09/14/09 Set: OFF
IBpayer Eight            Message Dt: 09/05/09 Set: ON

Nationally Active Payers - TRUSTED flag changes at FSC
=====
IBpayer Five              Message Dt: 09/12/09 Set: ON
IBpayer Seven            Message Dt: 09/10/07 Set: OFF
IBpayer Nine             Message Dt: 09/05/07 Set: ON

*** END OF REPORT ***

```

8.8 MailMan Notification to Link Payers

VistA automatically triggers a mailman message on a weekly basis to the IBCNE EIV Message Mail group if the following information is available:

- Total Number of Nationally Active Unlinked Payers with Potential Matches to active insurance companies.

Sample MailMan Notification

```

Subj: ACTION REQ: POTENTIAL PAYERS TO BE LINKED [#159564] 01/14/11@10:46
7 lines
From: EIV INTERFACE (IB) In 'IN' basket. Page 1 *New*
-----
--
TOTAL NUMBER OF PAYERS WITH POTENTIAL INSURANCE COMPANY MATCHES: 4
Immediate Attention Required:
-----

```

Please link the associated active insurance companies to these payers at your earliest convenience. Please visit the e-Business Projects Webpage on VistA University Website to download the Link Payer Instructions.
Enter message action (in IN basket): Ignore//

8.9 MailMan Notification to Activate Payers

VistA automatically triggers a mailman message on a weekly basis to IBCNE EIV Message Mail group if the following information is available:

- A List of Payers that meet the following criteria:
 - Locally inactive AND
 - Nationally Active AND
 - Have linked insurance companies.

Sample MailMan Notification

```
Subj: ACTION REQ: PAYERS TO BE LOCALLY ACTIVATED  [#159565] 01/14/11@10:46
12 lines
From: EIV INTERFACE (IB)  In 'IN' basket.  Page 1  *New*
-----
Nationally Active Payers that are Locally Inactive:
-----
USAA LIFE
INSURANCE
UniCare

UMR
(WAUSAU)
Immediate Attention Required:
-----
Please locally activate the payers after you link insurance companies to
them.
Please visit the e-Business Projects Webpage on VistA University Website to
download the Payer Activation Instructions.
Enter message action (in IN basket): Ignore//
```

8.10 eIV Ambiguous Policy Report

Purpose of Report

This report allows users to view ambiguous payer 270 Health Care Eligibility Benefits Responses. Ambiguous payer responses are those responses that do not have enough information for eIV to safely determine if the policy is active or not active.

Report Parameters

Search Criteria:

- Response Received Date Range
- All or Selected Payers
- All or Selected Patients
- All Responses or Most Recent (for a payer/patient combination)

Sort Criteria:

- Payer Name
- Patient Name

Sample Report

eIV Ambiguous Policy Report

Please select a date range to view ambiguous policy information that the eIV process turned up while attempting to discover previously unknown insurance policies. (Date range selection is based on the date that eIV receives the response from the payer.)

Start DATE: T-10000 (FEB 22, 1986)
End DATE: T (JUL 10, 2013)

Payer or <Return> for All Payers:

Patient or <Return> for All Patients:

Select one of the following:

- A All Responses
- M Most Recent Responses

Select the type of responses to display: A// 11 Responses

Select one of the following:

- 1 Payer Name
- 2 Patient Name

Select the primary sort field: 1// Payer Name

DEVICE: HOME// Linux Telnet/SSH

Compiling report data ...

eIV Ambiguous Policy Report Jul 10, 2013@12:19:19 Page: 1
Sorted by: Payer Name Responses Displayed: All
02/22/1986 - 07/10/2013
All Payers
All Patients

Payer: CIGNA
Patient: IB,PATIENT (SSN: xxx-xx-xxxx DOB: 01/07/1922)

Subscriber: IB,PATIENT

```

Subscriber ID: XXXXXXXXXX
Subscriber DOB:
Subscriber SSN: XX-XXX-XXXX
Group Name:
Group ID:
Whose Insurance:
Member ID:
Service Date: 11/19/2003
Effective Date:
Expiration Date:
Response Date: 02/17/2004

Subscriber Sex:
COB:
Date of Death:
Certification Date:
Payer Updated Policy:
Trace #: 377730280

eIV Ambiguous Policy Report
Sorted by: Payer Name
Payer: CIGNA
Patient: IB,PATIENT (SSN: xxx-xx-xxxx DOB: 01/07/1922)
Jul 10, 2013@12:19:34 Page: 2
Responses Displayed: All

```

*** END OF REPORT ***

8.11 eIV Inactive Policy Report

Purpose of Report

This report displays any inactive insurance policies that the eIV software identified while making 270 Health Care Eligibility Benefits Inquiries.

Users have the ability to define which inactive policies are included in the report based on the reported policy expiration date. This allows users the ability to search for inactive policies that expired within the payer's filing timeframe.

Report Parameters

Search Criteria:

- Response Received Date Range
- All or Selected Payers
- All or Selected Patients
- All Responses or Most Recent (for a payer/patient combination)
- Earliest Possible Expiration Date

Sort Criteria:

- Payer or Patient

Sample Report

eIV Inactive Policy Report

Please select a date range to view inactive policy information that the eIV process turned up while attempting to discover previously unknown insurance policies. (Date range selection is based on the date that

eIV receives the response from the payer.)

Start DATE: T-10000 (FEB 22, 1986)

End DATE: T (JUL 10, 2013)

Payer or <Return> for All Payers:

Patient or <Return> for All Patients:

Select one of the following:

A All Responses
M Most Recent Responses

Select the type of responses to display: A// 11 Responses

Earliest Policy Expiration Date to Select From: T-365// (JUL 10, 2012)

Select one of the following:

1 Payer Name
2 Patient Name

Select the primary sort field: 1// Payer Name

DEVICE: HOME// 0;80;9999 Linux Telnet/SSH

Compiling report data ...

eIV Inactive Policy Report

Jul 10, 2013@12:23:57 Page: 1

Sorted by: Payer Name

Responses Displayed: All

02/22/1986 - 07/10/2013

All Payers

All Patients

Payer: CIGNA

Patient: Patient,One (SSN: xxx-xx-xxxx DOB: 01/07/1922)

Subscriber: Patient,One

Subscriber ID: 000000XXX

Subscriber DOB:

Subscriber SSN: XXXXXXXXXX

Subscriber Sex:

Group Name:

Group ID:

Whose Insurance:

Member ID:

COB:

Service Date: 11/19/2003

Date of Death:

Effective Date:

Certification Date:

Expiration Date:

Payer Updated Policy:

Response Date: 02/17/2004

Trace #: 377730280

Payer: CIGNA

*** END OF REPORT ***

(This page included for two-sided copying.)

9 SCHEDULE/UNSCHEDULE MAILMAN MESSAGES

This existing feature allows users to schedule and unscheduled MailMan messages to their preference. Both Activate Payer and Link Payer messages can be scheduled using this one option "IBCNE EIV PAYER LINK NOTIFY" option. Note: This option is controlled by IRM access only.

The following screens will be displayed:

```
Select OPTION to schedule or reschedule: IBCNE
  1  IBCNE EIV PAYER LINK NOTIFY      Unlinked payers notification
  2  IBCNE IIV BATCH PROCESS          eIV NIGHTLY PROCESS

Schedule/Unschedule Options

Select OPTION to schedule or reschedule: unlinked PAYERS NOTIFICATION  IBCNE EIV
PAYER LINK NOTIFY      Unlinked payers notification
Are you adding 'IBCNE EIV PAYER LINK NOTIFY' as
a new OPTION SCHEDULING (the 503RD)? No//Y
```

```
Edit Option Schedule
  Option Name: IBCNE EIV PAYER LINK NOTIFY
  Menu Text:  Unlinked payers notification          TASK ID:

-----

QUEUED TO RUN AT WHAT TIME:  MMM DD, YYYY@HH:MM

DEVICE FOR QUEUED JOB OUTPUT:

QUEUED TO RUN ON VOLUME SET:

      RESCHEDULING FREQUENCY:      7D

      TASK PARAMETERS:

      SPECIAL QUEUEING: < This field is only for special jobs:
1. That need to start every time the system is rebooted.
2. Need to be persistent.
3. BOTH >

      MAIL CODE:
```

(This page included for two-sided copying.)

10 REAL TIME INSURANCE VERIFICATION INQUIRY

A real time eligibility verification inquiry is created when a new buffer entry has been entered in the file 355.33 (INSURANCE BUFFER). The inquiry is triggered immediately if the following information is available in the buffer entry:





- INSURANCE COMPANY NAME,
- PATIENT NAME,
- SUBSCRIBER ID (if patient is the subscriber),
- INSURED'S DOB (if patient is not the subscriber), and
- PATIENT ID (if patient is not the subscriber)

No inquiry will be created if:

- An inquiry already exists in the queue waiting to be transmitted.
- The same patient and policy is waiting for a response from the payer.
- The patient insurance information is locked by another user.

Real time inquiry is triggered by modifications to the following fields in file 355.33 (INSURANCE BUFFER):

- INSURANCE COMPANY NAME; or
- GROUP NAME; or
- GROUP NUMBER; or
- PATIENT NAME; or
- SUBSCRIBER ID; or
- INSURED'S DOB; or
- PATIENT ID



	<i>Remember – To utilize the benefit of real-time verification and get immediate responses, the facility should set the “HL7 Response Processing Method” to “Immediate”.</i>
	<i>Remember – The Request Electronic Inquiry option can be used to create a buffer entry for real-time verification. The response received for buffer entries created by EI; stay in the buffer and never automatically updates the patient insurance file.</i>
	<i>Remember – Real time verification inquiries are not triggered for buffer entries created by HMS data upload. Source = HMS</i>
	<i>Remember – The system does not send a registration request message to FSC each time a real time insurance verification is triggered.</i>

(This page included for two-sided copying.)

11 PURGING EIV FILES (IRM USERS)

11.1 Purge Transmission Queue and or Response File

IRM users have the ability to purge files from the IIV TRANSMISSION QUEUE file (#365.1) and IIV RESPONSE file (#365) beyond a date range. The **Purge eIV Transactions** option is on the **Purge Menu** which is on the **System Manager's Integrated Billing Menu**.

Step	Procedure
1	Access the IRM System Manager's Integrated Billing Menu .
2	Access the Purge Menu .
3	Access the Purge eIV Transaction option.
	<i>Note: purged data can fill journal files if the files are not purged routinely. It may be a good idea to temporarily disable journaling of the global that includes the IIV TRANSMISSION QUEUE (#365.1) and IIV RESPONSE (#365) files prior to running the purge if the files have not be purged in a long time.</i>
	The Purge eIV Transactions option is locked with the XUMGR security key.

The following screen will be displayed.

```
Purge Electronic Insurance Identification and Verification (IIV) Data Files

This option will allow you to purge data from the IIV Response File (#365)
and the IIV Transmission Queue File (#365.1). The data must be at least six
months old before it can be purged. Only insurance transactions that have a
transmission status of "Response Received", "Communication Failure", or
"Cancelled" may be purged. You will be allowed to select a date range for
this purging. The default beginning date will be the date of the oldest
eligible record in the system. The default ending date will be six months
ago from today's date. You may modify this default date range. However, you
may not select an ending date that is more recent than six months ago.

Enter the purge begin date: 10/04/2004// 3/8/09 (MAR 8, 2009)

Enter the purge end date: 04/08/2009// (APR 08, 2009)

You want to purge all IIV data created between 03/08/2004 and 04/08/2009.

OK to continue? NO//
```

Step	Procedure
4	At the Enter the Purge Begin Date: prompt, enter 6 Months plus 30 days for this example.
5	At the Enter the Purge End Date: prompt, press RETURN to accept the default.
6	At the OK to continue: prompt, enter YES .

Step	Procedure
	<i>Note: Files that are not older than six months cannot be purged.</i>

11.2 Purge Mailman Reminder

On the first day of each month, during the nightly batch extract process, the eIV application determines if historical data exists that is eligible to be purged. The process utilizes the same search criteria used by the **Purge eIV Transactions** utility described above. If at least one eligible eIV transaction exists, the mail group defined in the **General Parameters** section of the **IB Site Parameters** will receive the following MailMan reminder.

```

Subj: IIV Data Eligible for Purge [#13511224] 11/06/03@17:37 13 lines
From: IB IIV INTERFACE In 'IN' basket. Page 1
Subject: IIV Data Eligible for Purge

ATTENTION IRM: There are IIV TRANSMISSION QUEUE and
IIV RESPONSE records eligible to be purged.

File                               Eligible   Total
                                Count      Count
-----
IIV RESPONSE FILE (#365)           267        1993
IIV TRANSMISSION QUEUE FILE (#365.1) 331        2400
=====
Total                               598        4393

Please run option IBCNE PURGE IIV DATA - Purge IIV Transactions,
if you would like to purge the eligible records.

```

(This page included for two-sided copying.)

12 APPENDIX A – EIV TROUBLESHOOTING

12.1 No eIV Inquiries Transmitted

If the **Inquiries Sent** and **Responses Received** entries on the **eIV Statistical Report** both remain at zero while the **Queued Inquiries** entry on the report continues to increase over a period of time, then no 270 Health Care Eligibility Benefits Inquiry transmissions are being sent to FSC. If this situation continues and both the **Inquiries Sent** and **Responses Received** entries remain at zero, there is a communications problem with FSC. This section provides information to restore connectivity to FSC.

The eIV Statistical report should be reviewed the following day to ensure that 270 Health Care Eligibility Benefits Inquiry transmissions are once again being sent to FSC.

12.1.1 Site Parameters

- Verify MCCR Site Parameters
 - Check General Parameters
 - Messages Mailgroup must be: IBCNE EIV MESSAGE
 - IBCNE EIV MESSAGE mail group must be populated with valid personnel
 - Contact Person Name, Number and Email address must be valid
 - Check eIV Site Parameters
 - Mail Group for eIV Messages must be: IBCNE EIV MESSAGE IBCNE EIV MESSAGE mail group must be populated with valid personnel
 - Contact Person name must be valid

12.1.2 Restoring Connectivity to FSC (IRM)

- Verify that the names of the HL7 Logical Links were not changed. It must be **IIV EC**
- Verify the following settings for the HL7 Logical Link **IIV EC**
 - The institution field is **blank**
 - The domain field is set to **IIV.VITRIA-EDI.AAC.VA.GOV**
 - The AUTOSTART field is set to **enabled**
 - The TCP/IP address is set to **10.224.187.133**
 - The TCP/IP Port is set to **5100**
 - Verify that the HL7 Logical Link **IIV EC** is running
- Ask the IB Supervisor or insurance personnel to review the **eIV Statistical Report** the following day and confirm that connectivity has been restored with FSC
- If this does not resolve the connectivity issue with FSC for eIV, ask the IB Supervisor or insurance personnel to log a Remedy Ticket with VA Product Support

12.1.3 Requeue Batch Process (IRM)

- Verify the IBCNE IIV BATCH PROCESS taskman is still running

- Reschedule the IBCNE IIV BATCH PROCESS task

12.1.4 Restart HL7 Logical Link (IRM)

- Verify the IIV EC HL7 logical link is running
- Stop & Restart IIV EC HL7 logical link

12.2 No link between an Insurance Company and a Payer

For eIV to work, insurance companies must be linked to a payer. This is an important on-going process. To link insurance companies to a payer follow the basic guidelines listed below:

- Run the **eIV Payer Link Report** option by **Insurance Company List**, for all unlinked insurance companies. Use the keyword feature when running the report to narrow down the search. This will provide a report showing which insurance companies, whose name contains the keyword, that are not linked to a payer.
- Next, use the **Insurance Company Entry/Edit** option to link those insurance companies to the correct payer.

12.3 A Buffer or Appointment Extract Entry Failed to Create an Inquiry

When the eIV process is unable to create and transmit a 270 Health Care Eligibility Benefits Inquiry to a payer, the entry in **Process Insurance Buffer** will be flagged with an exclamation point. To view the error or problem that eIV encountered, expand the buffer entry using the **Expand Entry** action. Underneath the section **Buffer Entry Information**, the error message will be displayed as the **Current eIV Status**. Read the explanation of the problem. Sometimes there is more than one way to correct the problem. For a possible solution, follow the instructions listed below for the specific error. These instructions usually start with, **Action to take**.

For a list of all Error Messages that may display as the **Current eIV Status** of an insurance buffer entry, see Appendix B.

(This page included for two-sided copying.)

13 APPENDIX B – EIV ERROR MESSAGE DESCRIPTIONS

1. **eIV could not create an inquiry for this entry.** eIV could not match the insurance company name in the Insurance Buffer file to a valid insurance company name in the Insurance Company file.

Action to take: Correct the spelling of the insurance company name found in the buffer so that it matches one found in the Insurance Company file. Otherwise, contact the insurance company to manually verify this insurance information.

2. **eIV could not create an inquiry for this entry.** eIV matched the insurance company name in the Insurance Buffer file to more than one uniquely named insurance company in the Insurance Company file. This indicates that the Auto Match check or the Synonym check yielded multiple insurance companies from the Insurance Company file.

Action to take: Correct the spelling of the insurance company name found in the buffer so that it matches one found in the Insurance Company file. Otherwise, contact the insurance company to manually verify this insurance information. (*Advanced users: Use the option **Enter/Edit Auto Match Entries** to check the entries in the IIV AUTO MATCH file. Make sure there is no more than one entry in the IIV AUTO MATCH file that corresponds to the insurance company name found in this buffer entry.)

3. **eIV could not create an inquiry for this entry.** eIV matched the insurance company name in the Insurance Buffer file to more than one insurance company entry with the same name in the Insurance Company file. At least one of these matching entries are linked to a different payer.

Action to take: Run the **eIV Payer Link Report** option by **Insurance Company List**, for all linked insurance companies, using the keyword feature to narrow down the search. This will provide a report showing which payer the different insurance company records are linked to. Next, use the **Insurance Company Entry/Edit** option to correct those insurance companies that are linked to the wrong payer.

4. **eIV could not create an inquiry for this entry.** There is no link for this insurance company between the Insurance Company file and the Payer file.

Action to take: Use the Insurance Company Entry/Edit option to link this insurance company to the correct payer.

5. **eIV could not create an inquiry for this entry.** The payer is not nationally active for eIV.

Action to take: Contact the insurance company to manually verify this insurance information.

6. **eIV could not create an inquiry for this entry.** The payer is not locally active for eIV.

Action to take: Use the option **Payer Edit (Activate/Inactivate)** to locally activate this payer.

7. **eIV could not create an inquiry for this entry.** The payer does not accept electronic insurance eligibility requests. The eIV application data does not exist in the Payer file for this payer.

Action to take: Contact the insurance company to manually verify this insurance information.

8. **Information received via electronic inquiry indicates patient has active insurance.**

Action to take: Review the details listed in the **eIV Response Report** before processing this buffer entry.

9. **Information received via electronic inquiry indicates patient does NOT have active insurance.**

Action to take: Review the details listed in the **eIV Response Report** before processing this buffer entry.

10. **This buffer entry is currently being processed by the eIV application.** Unless instructed otherwise, there is no reason you should do anything with this buffer entry.

Action to take: None.

11. **The electronic response indicated an error of some kind that needs to be corrected before the insurance inquiry can be re-transmitted.**

Action to take: Contact the insurance company to manually verify this insurance information.

12. **An unknown and unforeseen error has occurred with this entry.**

Action to take: Log a Remedy ticket for this issue; include a trace number if available.

13. **eIV could not create an inquiry for this entry.** The insurance company found is listed as inactive in the Insurance Company file.

Action to take: Contact the insurance company to manually verify this insurance information.

14. **eIV was unable to electronically verify this insurance information due to a communication failure.**

Action to take: Contact the insurance company to manually verify this insurance information.

15. **The insurance company name for this buffer entry is blank.**

Action to take: Please review the Remedy ticket ROS-0402-53243. If the cause of the problem described in the Remedy ticket does not apply to the site, please log a new Remedy ticket for this issue; include a trace number, if available. Otherwise, please contact IRM and provide this buffer information and the Remedy ticket ROS-0402-53243.

16. **eIV could not create an inquiry for this entry.** The payer associated with this insurance company has been deactivated.

Action to take: Either edit this insurance company and link it to another payer, using the **Insurance Company Entry/Edit** option or contact the insurance company to manually verify this insurance information.

17. **eIV could not create an inquiry for this entry.** This patient's insurance must be verified manually because the Subscriber ID is missing.

Action to take: Contact the insurance company to manually verify this insurance information.

18. **An ambiguous response has been received.** It could NOT be determined whether the insurance company identified the patient as an active member of the insurance plan. Please contact the insurance company to manually verify this insurance information.

Action to take: Review the details listed in the **eIV Response Report** and contact the insurance company to manually verify this insurance information and correct any inaccuracies that may exist in the patient's insurance file.

19. **While processing a payer response, an unknown and unforeseen error has occurred with this entry.**

Action to take: Log a Remedy ticket for this issue; include a trace number if available. A user may process this buffer entry if a Remedy ticket has been logged with the associated trace number. To process this buffer entry, review the details listed in the **eIV Response Report** and contact the insurance company to manually verify this insurance information.

20. **When the Patient's ID is missing. New error message:**

Current eIV Status: Problem Identified

eIV could not create an inquiry for this entry. This dependant inquiry requires the Patient ID field to be populated before an inquiry can be transmitted electronically.

Action to take: Update the inquiry with the missing Patient ID or contact the insurance company to manually verify this insurance information.

21. **When the Subscriber ID is missing. New error message:**

Current eIV Status: Problem Identified

eIV could not create an inquiry for this entry. This inquiry requires the Subscriber ID field to be populated before an inquiry can be transmitted electronically.

Action to take: Update the inquiry with the missing Subscriber ID or contact the insurance company to manually verify this insurance information.

(This page included for two-sided copying.)

14 APPENDIX C – ACRONYMS/ABBREVIATIONS/TERMS

Term	Definition
AITC	Austin Information Technology Center.
EC	Eligibility Communicator – this refers to the National Health Insurance database that is housed at the FSC. The eIV software communicates with the Eligibility Communicator directly through HL7.
EDI	Electronic Data Interchange.
eIV	Electronic Insurance Verification. It is also the Insurance buffer entry source name in the Insurance Buffer List to signal entry processing by Electronic Insurance Verification.
Freshness Days	FRESHNESS DAYS (#350.9,51.01) is a general site parameter that determines how recent the insurance verification must be before eIV seeks to electronically re-verify it.
FSC	VA Financial Services Center – Austin, TX.
HL7	Health Level Seven, a standardized application level communications protocol that enables systems to exchange information.
HMO	Health Maintenance Organization.
IIV	Insurance Identification and Verification. This nomenclature was used during initial software development. The official title of the software is now eIV, although some programming options are still labeled with the old IIV nomenclature.
Insurance Buffer	The data store within the VistA database that holds proposed permanent insurance file changes for review and acceptance and upon acceptance, merges the changes into the permanent insurance files. The IBCN Insurance Buffer Process option available in VistA is also known as Process Insurance Buffer.
IRM	Information Resource Management.
MailMan	MailMan is an integrated data channel in VistA for the distribution of: Patches (KIDS builds), software releases (KIDS builds), computer-to-computer communications (HL7 transfers, Servers, etc.), Person-to-person messaging (Email).
MCCF	Medical Care Cost Fund.
MCCR	Medical Care Cost Recovery. This term has been officially replaced by MCCF though both are used interchangeably.
Payer	An entity that makes third party payments (the patient is the first party, VHA is the second party) for health care services. Health care insurance companies are payers.
Provider	A term used to describe both human and organizational entities that provide health care.
SRS	Software Requirements Specification.
Trusted Payer	A payer whose responses, the FSC determines can be used for Automatic Updates. It is also referred to as the Automatic Update Setting.
VA	Veterans Administration.
VAMC	Veterans Administration Medical Center.
VHA	Veterans Health Administration.
VISN	Veterans Integrated Service Network.
VistA	Veterans Health Information Systems & Technology Architecture, which includes the systems formerly known as the Decentralized Hospital Computer Program (DHCP) System.
WNR	Will not reimburse.
X12	A standardized application level communications protocol that enables systems to exchange information.