



VistA Imaging System

Technical Manual

January 2012 – Revision 36
MAG*3.0*121

Department of Veterans Affairs
Product Development
Health Provider Systems

VistA Imaging Technical Manual
VistA Imaging MAG*3.0*121
January 2012

Property of the US Government

This is a controlled document. No changes to this document may be made without the express written consent of the VistA Imaging Product Development group.

While every effort has been made to assure the accuracy of the information provided, this document may include technical inaccuracies and/or typographical errors. Changes are periodically made to the information herein and incorporated into new editions of this document.

Product names mentioned in this document may be trademarks or registered trademarks of their respective companies, and are hereby acknowledged.

VistA Imaging Product Development
Department of Veterans Affairs
Internet: <http://www.va.gov/imaging>
VA intranet: <http://vaww.va.gov/imaging>

Preface

The purpose of this manual is to provide information about the structure and function of the logical components of the Veterans Health Information Systems and Technology Architecture (VistA) Imaging V. 3.0 package (i.e., files, routines, and configuration that comprise the VistA Imaging System). Although this document describes some security functions, sensitive information regarding the VistA Imaging System can only be found in the Security Guide.

This document describes...

- How to implement and maintain the VistA Imaging System, its routines and files, options, and cross-references among files.
- How files are archived and purged.
- The established relations among the VistA Imaging System components and other components inside and outside of the Imaging software.

The VistA Imaging System Technical Manual is part of a suite of manuals that includes a release notes document, security guide, user manuals and installation guides. Information about various VistA Imaging System components (i.e., servers, workstations, and background processors) can be found in the Installation Guide.

The Food and Drug Administration classifies this software as a medical device. As such, it may not be changed in any way. Modifications to this software may result in an adulterated medical device under 21CFR820, the use of which is considered to be a violation of US Federal Statutes.

VA Policy states the following:

Those components of a national package (routines, data dictionaries, options, protocols, GUI components, etc.) that implement a controlled procedure, contain a controlled or strictly defined interface or report data to a database external to the local facility, must not be altered except by the Office of Information (OI) Technical Services (TS) staff. A controlled procedure is one that implements requirements that are mandated or governed by law or VA (Department of Veterans Affairs) directive or is subject to governing financial management standards of the Federal Government and VA or that is regulated by oversight groups such as the JCAHO or FDA. A controlled or strictly defined interface is one that adheres to a specific industry standard, will adversely affect a package and/or render the package inoperable if modified or deleted. For national software that is subject to FDA oversight, only the holder of the premarketing clearance (510(k)) is allowed to modify code for the medical device. The holder of a premarketing clearance is restricted to specifically designated TS staff that are located at the registered manufacturing site and operating in the designated production environment. Modifying FDA regulated software under any other conditions is a severe violation of the Code of Federal Regulations. Local, that is field-based, developers are prohibited from modifying national software that is certified by the FDA.

Revision History	
25 Jan 2012	MAG*3.0*121 updates (rev 36) C.Gilbert, H. Suri, L. Scorza - Updated sections 6.3.2, 10.1 and 18.1.5 A.2.2. - Added new section 12.8.3.
09 Nov 2011	MAG*3.0*104 updates (rev 35) R. Coney, A. Sunbear. - Updated sections 1.6, 3.5 and 12.10 - Added new sections 6.3.8 and 9.9.
01 Sep 2011	MAG*3.0*49,99,117 updates (rev 34) L. Jenkins, M. Kaji, H. Suri, L. Scorza MAG*3.0*49 – Updated sections 6.3.4, 8.2, 8.3, 8.4, 8.7, 12.1, 12.4.2. Added new sections: 8.2.1, 8.2.1.1, 8.2.1.2, 12.2 12.3, 13.1.3, 13.1.4, 13.1.5. MAG*3.0*99 – Updated sections 6.2.1, 6.3.4. MAG*3.0*117 – Updated sections 3.6.2, 6.3.1, 7.2.1.
31 May 2011	MAG*3.0*39 updates (rev 33) C. Gilbert, D. White - Updated sections 1.3, 5.1.1, 5.1.2, 5.3.1.5, 5.4, 5.5, 6.3.2, 6.3.3, 7.2.1, 8.2, 8.4, 9.3.2, 9.3.3, 9.3.3.1.1 to 9.3.3.1.8, and modified Chapter 9 name - Added new sections 9.5.5 and 9.5.6 and renumbered existing subheadings affected -- Re-organized subheadings in Chapter 9 - Made global corrections listed on page 1 of the Change Pages document
10 May 2011	MAG*3.0*106 updates (rev 32) C. Gilbert, D. White - Updated sections 3.6.3, 6.3.1, and 7.2. Added new section 3.11.
21 Mar 2011	MAG*3.0*115 updates (rev 31) M. Kaji, M. Turian, J. Kennedy - Updated sections 6.3.5 and Appendix A.5 for Patch 115. - Added sections 12.9 and 13.2 for Patch 115.
01 Feb 2011	MAG*3.0*105 and 98 updates (rev 30) R. Coney, C. Gilbert, H. Suri, D. White - Updated section 1.6 for Patch 105 - Updated sections 5.6, 6.3.7, 9.5.2.2, 9.5.2.3.1 for Patch 98
01 Dec 2010	MAG*3.0*53 and 66 updates (rev 29). L. Jenkins, L. Scorza - Updated sections 3.3, 6.2.1, 6.3.4, 7.2.1, 8.7.1, 8.8.1, and 12.2.2 for Patch 53. - Updated sections 1. 4, 6.2.1, and 12.2.2 for Patch 66.
05 Oct 2010	MAG*3.0*108, 90, 94 and 114 updates (rev 28). M. Kaji, D. White, J. Kennedy - Updated sections 3.6.4, 6.3.5, and Appendix 5 for Patch 90. - Updated sections 3.6.2, 10, and 18.1 for Patches 94 and 108. - Updated sections 6.3.3 and 15.1 for Patch 114.
09 Jul 2010	MAG*3.0*83 updates, minor corrections (rev 27). R. Coney, A. McFarren - Updated sections: 1.4, 3.6.1, and 5.1.1; new sections 1.6, 3.5, and 12.8 for MAG*3.0*83. - General corrections: 6.1.2, 12.4, 18.1.1, and 18.1.2.
10 Feb 2010	Patch 93 and Patch 101 updates, general cleanup (rev 26). M. Kaji, D. White, J. Kennedy - Updated sections 3.6.2, 6.3.1, 7.2.1, 7.2.3, 8.2, 11.1.2 for Patch 93. - New sections: 8.2 subsections, 11.1.3.4, 11.1.3.5, 11.1.3.6 for Patch 93. - Updated Sections 3.6.4, 6.3.5, 7.2.1, and Appendix A.5 for Patch 101.
20 Oct 2009	Patch 72 and Patch 54 updates; general cleanup (rev 25). A. McFarren, S. Littles - Updated sections 3.6.1 and 6.3.1 for Patch 72. - Revised content in section 6.2.3 (detail moved to Security Guide); removed outdated information from 15.1, 18.1.1, and 18.1.2.
19 Aug 2008	Patch 95 updates and misc. cleanup (rev 24) A. McFarren, D. Carozza - Updated and formatted patch list in section 3.1 - Updated section 6.3.1 for Patch 95 - Remove obsolete section related to test images and demo mode (6.3.1.1, 6.3.1.2, and 11.3.4.); remove redundant screen shots from Chapter 7; correct outdated content in section 9.5.2.1 (JL)
29 Feb 2008	Patch 59 updates (rev 23) - S. Davis, C. Huesman - Updated sections 6.3.1 and 6.3.3 for Patch 59. - New section Appendix B and B.1 for Means Tests Patch 59.

Revision History	
14 Jan 2008	Patch 76 updates and misc. corrections (rev 22). –A. McFarren, C. Huesman <ul style="list-style-type: none"> - Clarify MAG_DECOMPRESSOR content in section 6.3.6. - Updated sections 3.6.4 and 3.6.5 for p76
15 Nov 2007	Patch 81 and 69 updates (rev 21) - S. Davis, A. McFarren, R. Coney. <ul style="list-style-type: none"> - Removed old info from chapter 17, added pointer to new info for p81 - Updated sections 6.2.1, 6.2.2, and 12.2.2; removed section 6.2.4 for p69
04 May 2007	Patch 77, 46 and 65 updates (rev 20) – S. Davis, A. McFarren, C. Huesman <ul style="list-style-type: none"> - Added revision # to revision table, title page, and footer, corrected typo in section 9.5.4.4. - Updated sections 8.2 and 12.5.2 for Patch 77. - New section 12.6 for Imaging site reports Patch 77. - Updated sections 3.1, 3.3, 6.4.1, 6.4.3, 7.2.1, 8.2, 12.3, and 15.1 for Patch 46. - New section 12.5 for COW communication Imaging site reports for Patch 46. - Updates sections 3.3, 7.2.1, and 8.7 for Patch 65.
21 Jul 2006	Patch 50 and 20 updates (rev 19) - S. Davis, A. McFarren, R. Coney. <ul style="list-style-type: none"> - Updated section 12.5.2 for patch 78. - Updated the following sections for patch 20: 1.3, 5.1.1, 5.3.1.5, 6.4.2-3, 9.3.2, 9.3.3.1.1-8, 11.1.1 and 12.5.2. - Updated section 7.2.1 for patch 50.
30 Jun 2006	Patch 51 and 18 updates (rev 18) – A. McFarren, C. Huesman. <ul style="list-style-type: none"> - Added new section 6.4.6 and updated section 7.2.1 for patch 51. - Updated sections 3.3, 3.6, 5.1.2, 6.4.5, 7.2.1, 8.3, and A.5 for patch 18. - Updated obsolete information in sections 1.4 and 7.2.3
12 Dec 2005	Patch 57 updates (rev 17)- A. McFarren, C. Huesman. <ul style="list-style-type: none"> - General typo corrections and formatting cleanup throughout document. - Removed old operating system references throughout document - Corrected/updated outdated content in sections 3.1, 3.6, 6.1.1, 6.3, 7.2.1, 8.2, 8.7, 9.5.4.4, and 12.5.2.1 - Removed outdated content from sections: 1.5.3, 3.3, 3.4, 5.2.1, 5.3.2, 5.5, 6.4.4.2, 6.4.5, 7.4, 9.5.4.4, 13.1.2, and A.3 - Incorporated p45 change page: new chapter 18 - New section 3.10 covering Microsoft patch installation.
5 April 2005	Additional Updates (rev 16): <ul style="list-style-type: none"> - Section 6.1.1 Checksums
28 Mar 2005	Additional Updates (rev 15): <ul style="list-style-type: none"> - Sections 6.4.1, 7.2.4, 10.2.3.1, 10.2.3.3, and 11.1.2, 16.1.2
9 Mar 2005	Patch 48 Updates (rev 14): <ul style="list-style-type: none"> - Sections 3.6 Security Keys, 6.1.1 Checksums, 6.4.1 Clinical Workstation Files, 6.4.2 Background Processor Files, 7.2.4 Further Information, 10.2.3.1 Input Array Sent to Import API, 10.2.3.3 Results Array Returned to Status Handler, 11.1.2 Delete Images and Pointers
30 Sept 2004	Patch 8 Updates (rev 13): <ul style="list-style-type: none"> - Section 3.3 Site Parameters - Section 3.6 Security Keys - Chapter 6 – Section 6.1.1 Routine Descriptions - Section 6.4.1 Clinical Workstation Files - Section 7.2.1 VA FileMan Files - Section 8.2 Imaging System Manager Menu - Section 10.2.3.1 Input Array Sent to Import API - Section 11.3.4 VistA Imaging Display, Demo Mode - Section 11.3.5 VistA Imaging Capture, Test Mode
23 June 2004	Patch 33 Updates (rev 12): <ul style="list-style-type: none"> - Section 6.4.1 Clinical Workstation Files - Appendix A.1 Clinical Workstation Error Messages - Appendix A.4 Setup Error Messages

Revision History	
30 April 2004	Patch 11 Updates (rev 11): <ul style="list-style-type: none"> - Chapter 6 Routine Descriptions - Section 7.2.1 VA FileMan Files - Section 8.9 Access to DICOM Gateway RPCs - Section 12.2.2 DICOM RPC Broker Calls
6 April 2004	Patch 3 Updates (rev 10): <ul style="list-style-type: none"> - Revised sections 8.2, 11.1.1, and 12.5.2.1 to reflect the removal of Edit Image Write Location - Removed redundant sections 8.2.1-8.2.1.2 (i.e.,MAG ENTERPRISE information already exists in section 12.5). - Documented revisions for patches 7, 17, 23, 27, 25, 22, and 10.
9 Dec 2003	Patch 10 Updates (rev 9): <ul style="list-style-type: none"> - Section 7.2.1 VA FileMan Files
5 Nov 2003	Patch 22 Updates (rev 7): <ul style="list-style-type: none"> - Appendix A.6 VistARad Error Messages
30 Sept 2003	Patch 25 Updates (rev 8): <ul style="list-style-type: none"> - Section 7.2.1 VA FileMan Files
23 July 2003	Patch 23 Updates (rev 6): <ul style="list-style-type: none"> - Section 8.2 Imaging System Manager Menu - Section 12.5 MailMan Messaging Patch 27 Updates: <ul style="list-style-type: none"> - Section 8.2 Imaging System Manager Menu - Section 12.5 MailMan Messaging
7 May 2003	Patch 17 Updates (rev 5): <ul style="list-style-type: none"> - Section 7.2.1 VA FileMan Files - Section 7.5 Imaging Entity Relationship Diagram and Detailed Information
30 April 2003	Patch 19 Updates (rev 4) to section 8.2 Imaging System Manager Menu
30 Mar 2003	Patch 16 Updates (rev 3): to Appendix A.5 VistARad Installation Error Messages
10 Dec 2002	Patch 9 Updates (rev 2): <ul style="list-style-type: none"> - Addition of files 2006.035, 2006.036, 2006.59, 2006.5906, 2006.596 - Additional fields for file 2005.2 - Additional security key MAGJ DEMAND ROUTE - Modification to table 3.3 (collapse line-items for DICOM Gateway)
6 Sept 2002	Patch 7 Updates (rev 1): <ul style="list-style-type: none"> - Created changes pages for Sections 3.6, and 7.2.1. - Chapter 10 – revised

Table of Contents

Preface.....	iii
Chapter 1 Introduction.....	1
1.1 Multimedia Patient Record	1
1.2 Automated DICOM Image Acquisition	2
1.3 Background Processor.....	2
1.3.1 Queue Processor	2
1.3.2 Purge.....	2
1.3.3 Verifier	2
1.4 Typical Configuration	3
1.5 DICOM Gateway Networking Topology Options	3
1.5.1 Commercial DICOM Devices Connected to Main Network Backbone.....	3
1.5.2 Commercial DICOM Devices on Separate Physical Networks	4
1.6 Cross-Enterprise Image Sharing	4
Chapter 2 Orientation.....	7
2.1 Documentation Conventions.....	7
2.2 Special Workstation Procedures	7
2.3 Mouse/Windows Controls	8
Chapter 3 Implementation and Maintenance.....	11
3.1 VistA Package Requirements.....	11
3.2 Hardware and Software Requirements	11
3.3 Imaging Site Parameters	12
3.4 Maintenance of Software on DICOM Gateway Workstations.....	14
3.5 Changes to IP Addresses or Ports	14
3.6 Security Keys	14
3.6.1 General Security Keys	14
3.6.2 Security Keys for Clinical Display	15
3.6.3 Security Keys for Clinical Capture.....	16
3.6.4 Security Keys for VistARad	17
3.7 Workstation Hardware	19
3.8 Changes to DICOM Modalities	19
3.9 Changes to Windows Servers and Security	19
3.10 Microsoft Patch Installation Guidelines.....	19
3.11 Parameter Definition.....	20
Chapter 4 Security Software Maintenance.....	21
4.1 Security and Anti-virus Considerations	21

Chapter 5	Space, Staffing, and Standard Operating Procedures for VistA Imaging	23
5.1	Infrastructure Resources.....	23
5.1.1	Networking.....	23
5.1.2	Space.....	23
5.1.3	Power.....	24
5.1.4	Remote Access.....	24
5.1.5	Security.....	24
5.2	Support.....	24
5.2.1	IRM Support Staff Requirements.....	24
5.2.2	Biomedical Engineering Support Staff Requirements.....	25
5.2.3	ADPAC Staff Requirements for Support for All Medical Services.....	25
5.3	Daily Activities.....	26
5.3.1	IRM Morning Routine.....	26
5.4	Maintenance.....	28
5.5	Weekly Activities.....	28
5.6	Other Periodic Activities.....	28
5.7	Scheduled Down Time for VistA Servers.....	29
Chapter 6	Routine Descriptions.....	31
6.1	VistA Imaging Routines on the VistA Hospital Information System.....	32
6.1.1	Build Checksums.....	32
6.1.2	Package Checksums.....	33
6.1.3	Routine Descriptions.....	34
6.2	DICOM Gateway Routines.....	34
6.2.1	Checksums of VistA Imaging DICOM Gateway Routines.....	34
6.2.2	DICOM Gateway Routine Descriptions.....	37
6.2.3	Kernel RPC Broker Routines.....	37
6.3	Non-M Routines Distributed as Executable Files.....	37
6.3.1	Clinical Workstation Files.....	38
6.3.2	Background Processor Files.....	43
6.3.3	Online Help Files.....	44
6.3.4	DICOM Gateway Files.....	44
6.3.5	VistARad Workstation Files.....	52
6.3.6	MAG_Decompressor Files.....	53
6.3.7	Storage Site Utilities.....	53
6.3.8	VIX Files.....	53
Chapter 7	VistA Imaging System M Files.....	55
7.1	Introduction.....	55
7.2	VA FileMan Files that are Part of the VistA Imaging System.....	56
7.2.1	VA FileMan Files.....	56
7.2.2	More Detailed Information.....	62
7.3	Input Templates.....	63
7.3.1	Further Information.....	63
7.4	File List.....	64

7.5	File Security	64
7.6	Global Journaling.....	66
7.7	VistA System Outages	66
Chapter 8 Exported Options.....		67
8.1	Introduction: INI File Setup and Configuration of Workstations	67
8.2	Imaging System Manager Menu	67
8.2.1	IMAGING HL7 MESSAGING MAINTENANCE [MAG HL7 MAINT]	68
8.3	MAG REASON EDIT [MAG SYS MENU]	70
8.4	MAG CLIENT VERSION REPORT.....	71
8.5	Imaging VistARad System Options	72
8.6	Imaging MAG WINDOWS Menu Option.....	72
8.7	Imaging VistaRad MAGJ VISTARAD WINDOWS.....	72
8.8	Imaging MAG JB OFFLINE Menu option	73
8.9	Imaging DICOM Menu.....	73
8.9.1	MAG IMPORT DICOM OBJECTS Menu Option	73
8.10	Imaging Menu Options Documentation.....	74
8.10.1	MAG DICOM IMPORTER Menu Option.....	75
8.11	Access to DICOM Gateway RPCs.....	75
Chapter 9 Archiving, Purging, Verifying, and Backup.....		77
9.1	Introduction.....	77
9.2	Archiving and Purging of Image FileMan Entries	77
9.3	Archiving and Purging of Image Files	77
9.3.1	Automatic Image File Migration	77
9.3.2	Purging RAID Shares	77
9.4	Queue Management	78
9.4.1	Server Size.....	79
9.4.2	Background Processor: Open Log Functions	80
9.4.3	Check Status of the JBTOHD Report.....	84
9.5	Background Processor Configuration Tools	84
9.5.1	Configuring BP Servers.....	84
9.5.2	Background Processor Purge Configuration	89
9.5.3	Network Location Manager: Adding a New Magnetic or Jukebox Storage Location and other Storage Types	94
9.5.4	Background Processor Imaging Site Parameters Edit Functions	96
9.5.5	Scheduled BP Verifier	102
9.5.6	Scheduled RAID Group Advance	104
9.6	Background Processor Image and File Entry Verifier	106
9.7	Imaging Server and Jukebox Backup Information.....	107
9.8	DICOM-related Backup and Purge	107
9.8.1	Growing entities	107
9.8.2	Jukebox Archive.....	108
9.8.3	Purge Image Files from VistA Magnetic Cache Manually.....	110
9.8.4	Entities That Are Purged at the Discretion of the Site Supervisor	112
9.9	VIX-related Backups.....	113

Chapter 10 Callable Routines/Application Programmer Interfaces (APIs).....	115
10.1 Import API	115
10.1.1 VA Policy	115
10.1.2 FDA Policy	116
10.2 VistA Imaging Import API.....	116
10.2.1 Terms of Use	116
Chapter 11 Error Recovery, Troubleshooting, and Testing	117
11.1 Error Recovery	117
11.1.1 Server or Disk Drive Failure	117
11.1.2 Delete Image and Pointers	117
11.1.3 Correcting Image Capture Errors.....	118
11.2 Troubleshooting / Error Messages	119
11.3 Test Software Available for Troubleshooting.....	119
11.3.1 Introduction	119
11.3.2 PING, TRACERT.....	120
11.3.3 RPCTEST.EXE	120
11.3.4 VistA Imaging Capture, Test Mode	120
Chapter 12 External Relations.....	121
12.1 HL7 Messages.....	121
12.2 HL7 Application Parameters.....	121
12.3 HL7 Logical Link.....	121
12.4 Broker Calls	122
12.4.1 Imaging Broker Calls.....	122
12.4.2 DICOM RPC Broker Calls	123
12.5 Windows Messaging.....	125
12.6 Integration Control Registrations	125
12.7 CCOW Communication.....	126
12.8 Mailman Messaging.....	126
12.8.1 “Image Cache Critically Low” Messages	127
12.8.2 “Image Site Usage” Messages	127
12.8.3 Watermarking Messages	136
12.9 Imaging Site Reports.....	137
12.9.1 Document Counts Report	138
12.9.2 Image Count by User Report	138
12.9.3 Means Test Report.....	142
12.9.4 Package Index Contains ‘Note’ Report	142
12.10 VistA Site Service.....	147
12.11 VistARad External Relations	147
12.11.1 Voice Dictation Software	147
12.11.2 Medical Visualization/3D Reconstruction Software.....	148
12.11.3 Medical Imaging Resource Center (MIRC) “Teaching File” server	148

Chapter 13 Internal Relations.....	149
13.1 Dependencies	149
13.1.1 Entry/Exit Logic	149
13.1.2 Synchronization.....	149
13.1.3 Radiology HL7 v2.1 Protocols	149
13.1.4 Radiology HL7 v2.4 Protocols	150
13.1.5 VistA Imaging ADT Protocols	151
13.1.6 Radiology Protocols (VistARad).....	153
13.1.7 Patient Movement Protocol (DICOM)	153
13.2 VistARad Internal Relations	154
13.2.1 VistA Site Service	154
13.2.2 VistA Imaging Exchange (VIX) servers.....	155
Chapter 14 Package-Wide Variables	157
Chapter 15 Online Documentation.....	159
15.1 Online Help.....	159
Chapter 16 Site-Specific Implementation	161
16.1 Site-Specific Implementation.....	161
16.1.1 Radiology Report Transcription Service	161
16.1.2 HL7 MESSAGE TEXT File (#772)	161
16.1.3 Incomplete DICOM Files Received on the DICOM Image Gateway	162
Chapter 17 Database Integrity Checking	163
17.1 VistA Imaging MAG SYS MENU	163
17.2 Clinical Display Application.....	164
17.3 VistARad Application.....	164
17.4 Verifier Application in the Background Processor	164
Chapter 18 Remote Image Views.....	165
18.1 Configuration for Remote Image Views	165
18.1.1 Enabling/Disabling Remote Image Views for Site.....	165
18.1.2 Updating VistA Site Service URL	166
Appendix A: Error Messages.....	167
A.1 Clinical Workstation Error Messages	167
A.2 BP Error Messages	171
A.2.1 General BP Error Messages	171
A.2.2 Queue Processor Application Error Messages	181
A.2.3 Verifier Application Error Messages	186
A.2.4 Purge Application Error Messages.....	191
A.3 DICOM Gateway Error Messages.....	192
A.4 Clinical Display/Capture Setup Error Messages	192
A.5 VistARad Error Messages.....	193

Table of Contents

Appendix B Means Tests	203
B.1 Sending Means Tests to the HEC	203
Glossary.....	205
Index.....	209

Chapter 1 Introduction

1.1 Multimedia Patient Record

The VistA Imaging System is an extension to the Veterans Health Information System Technology Architecture (VistA) hospital information system that captures clinical images, scanned documents, motion images, and other non-textual data files and makes them part of the patient's electronic medical record. Electrocardiogram (EKG) waveforms can be displayed as part of the electronic medical record. Image and text data are provided in an integrated manner that facilitates the clinician's task of correlating the data and making patient care decisions in a timely, accurate way.

The system is designed to provide the treating physician with a complete view of patient data and, at the same time, allow consulting physicians to have access to the image and text data. It serves as a tool to aid communication and consultation among physicians -- whether in the same department, in different medical services, or at different sites.

The VistA Imaging System is unique in that management of the medical images is handled by the hospital information system, allowing very close integration of multimedia data with traditional patient chart information.

Clinical users can capture images during procedures or images can be added at a later time, for example during the creation of a report or progress note. Automatic image acquisition can be performed by DICOM gateways. Images can be acquired from commercial radiology Picture Archiving and Communications Systems (PACS) or directly from radiology devices. The transfer of patient demographic and order information to the commercial PACS or radiology device plays a key role in the ability to add these images to the patient's online medical record.

VistA Imaging workstations located throughout the hospital capture and display a wide variety of medical images including:

- Cardiology
- Endoscopy (GI, pulmonary, cystoscopy, arthroscopy, bronchoscopy, etc)
- Ultrasound (vascular, echo cardiology)
- Microscopic (Surgical Pathology, Cytology, Autopsy, Hematology)
- Surgery
- Ophthalmology
- Dental
- Dermatology
- Radiology images
- Nursing
- Podiatry
- Scanned advanced directives, consent forms, and other documents

VistA Imaging VistARad diagnostic workstations are generally located in the Radiology Reading room and are used for softcopy reading of Radiology images. These workstations provide functions for the Radiologist to retrieve and display full-resolution images, associated Radiology reports, and update the Radiology exam status.

1.2 Automated DICOM Image Acquisition

DICOM is the abbreviation for the **D**igital **I**maging and **C**OMmunications in **M**edicine standard. DICOM brings open systems technology to the medical imaging marketplace and enables VistA to communicate directly with commercial medical imaging equipment.

DICOM is a set of networked client/server applications that are implemented on top of TCP/IP. DICOM is part of the VistA networked application suite, along with CPRS, Kernel Broker, MS Exchange, and Windows-based file servers. Similar networking techniques are used for installing and maintaining all of these applications.

1.3 Background Processor

The VistA Imaging Background Processor is a component in the VistA Imaging System and runs on a Windows file server. The Background Processor ensures the archiving of DICOM and clinical images from short-term storage (RAID groups) onto the archive device (a jukebox) for long-term storage. These images are stored indefinitely on the archive device.

1.3.1 Queue Processor

The Queue Processor moves image data between RAID and an archive device or remote location. This activity is in response to activity from Capture and Display application requests.

1.3.2 Purge

The Purge removes image files from the RAID Image shares based on file dates. An automatic purge process can be configured when RAID storage becomes low and a regularly scheduled purge can be configured to operate during off-peak hours.

1.3.3 Verifier

The Verifier maintains and checks data integrity between the VistA Imaging database and the storage network location.

1.4 Typical Configuration

The diagram below shows a typical configuration of a VistA Imaging system.

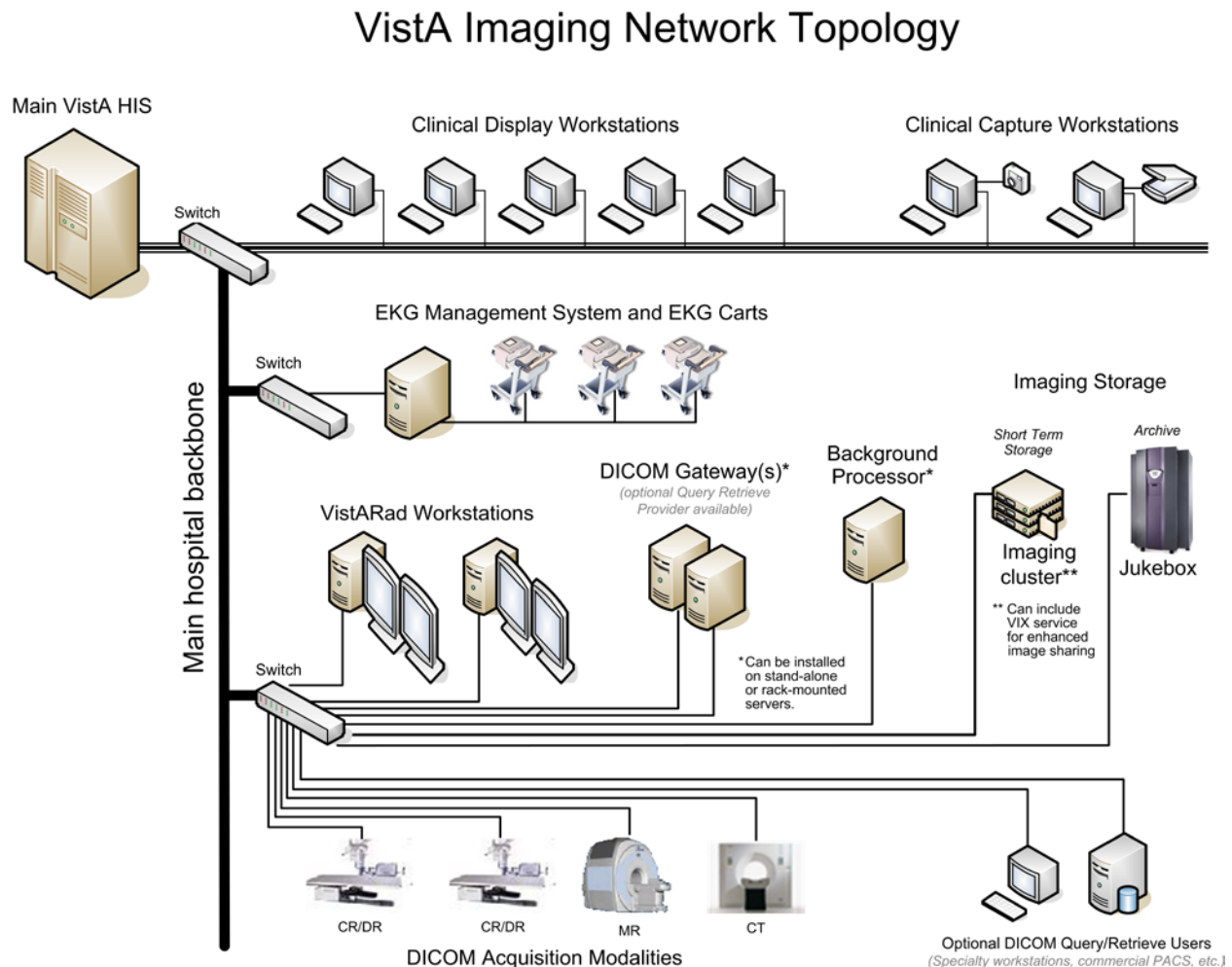

1.5 DICOM Gateway Networking Topology Options

The VistA DICOM Gateways may use either one or two networking interfaces depending upon whether the commercial DICOM devices are directly connected to the main network backbone or are located on separate physical networks.

1.5.1 Commercial DICOM Devices Connected to Main Network Backbone

Some sites may choose to have all devices (workstations, main hospital computer, DICOM imaging producing equipment, etc.) connected to a single high-speed switched network backbone. In this case, the VistA Image Servers, VistA DICOM Gateways, and Background Processor will all connect to the same switch on the high-speed backbone. Clinical and capture workstations will be connected to segments that feed into the backbone.

Single High-Speed Switched Network

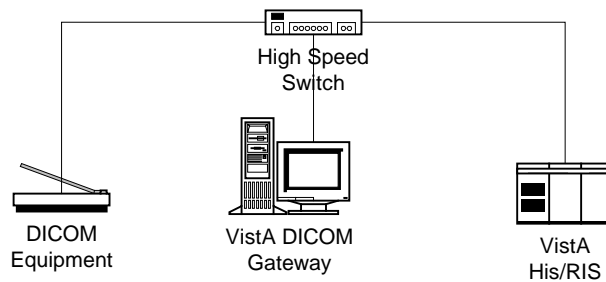

1.5.2 Commercial DICOM Devices on Separate Physical Networks

Other sites may choose to have a separate dedicated network for the commercial DICOM devices and DICOM gateways. In this case, the VistA DICOM Gateway must have two network interfaces, one to connect to the main hospital network backbone, and the second to connect to the dedicated network for the commercial DICOM devices. This keeps the traffic on the two networks separate.

Separate Dedicated DICOM Network

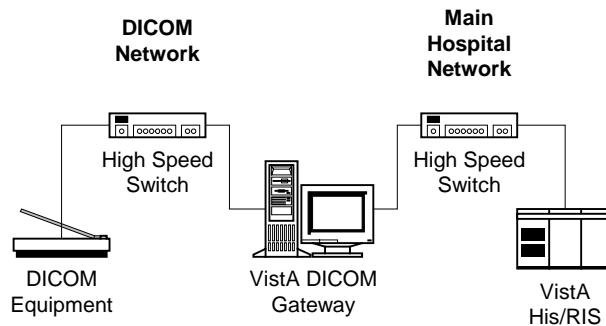

1.6 Cross-Enterprise Image Sharing

Sites that implement the VistA Imaging Exchange (VIX) service get:

- More efficient access to all types of remotely stored images and image-like artifacts (such as scanned documents) from other VA sites that also have a VIX.
- Remote radiology worklist monitoring and access to remotely stored radiology exams using VistARad without the need for routing.
- Access to DoD images for shared VA/DoD patients.

For more information about the VIX, see the *VistA Imaging VIX Administrator's Guide*.

Sites that implement the Advanced Web Image Viewer (AWIV) get:

- The ability to view images associated with progress notes and radiology reports from within VistAWeb.
- Access to images from any VA site via the Centralized VistA Imaging Exchange (CVIX) service, which is an extension of the VIX service.

The AWIV can be accessed only from within the VistAWeb application. AWIV installation information is covered in this manual. For information about using the AWIV, see the *VistA Imaging AWIV User Guide*.

Chapter 2 Orientation

2.1 Documentation Conventions

The following conventions are used in this manual.

Convention	Description
Bold type	User Keyboard Entry
<RET>	Return key or Enter key
<SHIFT>	Shift key
<ESC>	Escape key
<Num Lock>	Top left key on the numeric keypad (above the 7); may also be labeled Numeric Lock; this makes any keypad key activate the number shown on its surface; it is the equivalent of a SHIFT LOCK for alphabetic keys.

2.2 Special Workstation Procedures

Command	Action
Reboot	<ol style="list-style-type: none">1. Push the RESET button on the front of the workstation.2. If there is no RESET button, power the workstation off and then on; the computer will reboot.3. It will perform a virus check and load all required software; this takes about 30-60 seconds.4. When the reboot process is complete, you should be able to sign back into the workstation.

2.3 Mouse/Windows Controls

Control	Description
<p>Mouse button click</p>	<ul style="list-style-type: none"> • The mouse is a device used to point at positions on the screen. • The mouse may have one, two, or three buttons. • The mouse should be held at the end opposite the cord so the fingers can press the buttons. • The buttons are referred to as the "Right Mouse Button", the "Left Mouse Button", and the "Center Mouse Button". When the mouse is rolled around on a flat surface, the arrow cursor on the screen will move correspondingly. • Pressing and releasing a button is called "clicking". You may position the arrow over a portion of the window, such as a button or scroll bar, and then click. This will cause the computer to do something such as display an image, depending on the window. • When the instructions tell you to "press the mouse button," you can assume that you are to press the left mouse button.
<p>Select</p>	<p>You may also select a rectangular area on the window, by following these steps:</p> <ol style="list-style-type: none"> 1. Position the arrow cursor so it is over the left upper corner of the area to be selected. 2. Press the left mouse button down and hold it down while you move the mouse to the right lower corner of the rectangle to be selected. 3. Release the mouse button. You will see a dotted rectangle on the window around the area selected.

Control	Description
Drag	<p>If you want to move a window to another area of the window (e.g., to see something on a window that is underneath), follow these steps:</p> <ol style="list-style-type: none"> 1. Position the cursor over the top colored title area of the window to be moved. 2. Press the left mouse button down and move the mouse until the window is where you want it. 3. Release the mouse button. <p>This is called "dragging" a window.</p>
<=>	<p>You may adjust the size of the window by following these steps:</p> <ol style="list-style-type: none"> 1. Place your mouse at the edge of the window that you would like to move. 2. When you see the cursor turn into a double ended arrow <=>, hold the left mouse button down, and move the mouse until the image is the width and/or height that you would like. 3. Let go of the left mouse button.

Chapter 3 Implementation and Maintenance

3.1 VistA Package Requirements

The VistA Imaging System is designed to be used in conjunction with the following VistA packages. Kernel, FileMan and RPC Broker are required packages. Other packages will depend on the site's implementation requirements.

- Kernel V. 8.0
- FileMan V. 22
- RPC Broker 1.1 – required for interfacing with the hospital database.
- Consult/Request Tracking V. 3.0-required for capturing images to the Consult/Request Tracking package.
- Medicine V. 2.3– required for capturing images to the Medicine package.
- Laboratory V. 5.2 – required for capturing images to the Laboratory package.
- Radiology V. 5.0 – required for capturing images to the Radiology package.
- Surgery V. 3.0 – required for capturing images to the Surgery package.
- TIU V. 1.0 – required for capturing images to the Text Integration Utility package.
- PIMS V 5.3 - required for displaying Patient Profile report and patient security lookup.
- Health Summary 2.7 – required for displaying Health Summary report.

The software developers for the following patches have developed callable routines to support GUI applications such as the VistA Imaging System. Please ensure that the following patches are installed for the applications that VistA Imaging will be used with. Patches are available via the National Patch Module on FORUM.

DG*5.3*124	LR*5.2*121	RA*5.0*23
DG*5.3*249	MC*2.3*30	RA*5.0*53
DG*5.3*265	TIU*1.0*1	SR*3.0*66
DG*5.3*276	TIU*1.0*47	XWB*1.1*28
DG*5.3*277	TIU*1.0*63	XWB*1.1*41
GMRC*3.0.51	TIU*1.0*223	XWB*1.1*34

3.2 Hardware and Software Requirements

Contact your Implementation Manager for information about VistA Imaging equipment.

The VistA Imaging software requires that a network be present with sufficient capacity to transport image files in a reasonable amount of time. All network set-ups must be completed **before** VistA Imaging computers can be installed.

3.3 Imaging Site Parameters

Within the VistA Imaging System, a number of sets of tunable parameters are used. The table below indicates which components use which parameters.

Name	Notes	Used by →	Back. Proc.	DICOM G/W	Capture	TeleReader	Display	VistARad
IMAGING SITE PARAMETERS (#2006.1)	Stored on VistA Host; general site parameters for Imaging.		Yes	Yes	Yes	Yes	Yes	Yes
DICOM OBJECTS TO BE IMPORTED (#2006.5751)	Stored on VistA Gateway; contains a list of DICOM Objects that were transmitted to the Gateway and need to be imported.		-	Yes	-	-	-	-
IMPORTABLE DICOM OBJECTS (#2006.5752)	Stored on VistA Host and contains a list of DICOM Objects that were transmitted to all the Gateways and need to be imported. (super set of file #2006.5751)		-	Yes	-	-	-	-
DICOM RADIOLOGY PROCEDURE MODIFIERS (#2006.5757)	Stored on VistA Gateway, contains a list of Radiology Procedures Modifiers on VistA.		-	Yes	-	-	-	-
DICOM RADIOLOGY PROCEDURES (#2006.5758)	Stored on VistA Gateway; contains a copy of the Radiology procedures on VistA along with their image type and outside imaging location.		-	Yes	-	-	-	-
OUTSIDE IMAGING LOCATION (#2006.5759)	Stored on VistA Host; general site parameters for Imaging.		-	Yes	-	-	-	-
APPLICATION ENTITY TITLE (#2006.588)	Stored on VistA Gateway, contains a list of the application entity titles, their aliases, and their description. Built from dictionary file AE_TITLE.DIC.		-	Yes	-	-	-	-
IMAGING USER PREFERENCE (#2006.18)	Stored on VistA Host; user- and site-specific parameters for Capture and Display workstations.		-	-	Yes	Yes	Yes	-

Name	Notes	Used by →	Back. Proc.	DICOM G/W	Capture	TeleReader	Display	VistARad
MAGJ USER DATA (#2006.68)	Stored on VistA Host; user-specific parameters for VistARad workstations.		-	-	-	-	-	Yes
MAG VISTARAD SITE PARAMETERS (#2006.69)	Stored on VistA Host; site-specific parameters for VistARad workstations.		-	-	-	-	-	Yes
MAG CT PARAMETER (#2006.621)	Stored on VistA Host; contains parameters for performing Hounsfield calculations or TGA-to-DICOM conversions of CT images processed before the installation of Patch 50.		-	-	-	-	-	Yes
MAG CR PARAMETER (#2006.623)	Stored on VistA Host; contains correction parameters for older CR images processed by specific versions of the Fuji Flash IIP consoles.		-	-	-	-	-	Yes
DICOM GATEWAY PARAMETER (#2006.563)	Individual copies stored in ^MAGDICOM on each DICOM Gateway. Must be accessible even VistA is not accessible.		-	Yes	-	-	-	-
MAG308.INI	Individual copies stored on each Capture and Display workstation; contains workstation specific parameters.		-	-	Yes	Yes	Yes	-
MAGJ.INI	Individual copies stored on each VistARad workstation; contains workstation specific parameters.		-	-	-	-	-	Yes

3.4 Maintenance of Software on DICOM Gateway Workstations

This section is obsolete as of the release of Patch 11. Refer to the Imaging DICOM Gateway Installation Guide for information about software installation and maintenance.

3.5 Changes to IP Addresses or Ports

Any changes to the IP addresses for the VistA servers or changes to the Kernel RPC Broker Listening port(s) will require updating on the VistA Imaging workstations (refer to the Broker Technical and User Manuals).

The VistA Site Service will also need to be updated with the changes. (If the site service is not updated, remote VA sites will not be able to access locally stored images.) For information about the VistA Site Service, see section 12.10.

Sites that have implemented a VIX will need to update their VIX's configuration to use the new site service values. This is done by re-running the VIX installer. Contact VHAVIXSETUP@va.gov for guidance.

Sites that have implemented a VIX will also need to update their VIX's configuration after the site service has been updated. This is done by re-running the VIX Installation wizard which will detect the new connection information and reconfigure the VIX accordingly. See the *VIX Installation Guide* for more information.

3.6 Security Keys

There are a number of security keys associated with the VistA Imaging system. The following tables summarize security keys and their function.

3.6.1 General Security Keys

Note: Please be cautious when assigning the following keys; the keys are intended for Imaging Support personnel. Review the descriptions before assigning these keys.

General Security Keys	
MAGDFIX ALL	Allows the holder to perform DICOM CORRECT functions on any entry in the DICOM FAILED IMAGES file (#2006.575). Users who do not hold this key will only be able to correct entries that were captured on their own site's gateway.
MAG DELETE	This key allows the holder to delete images from the IMAGE file (#2005). Pointers in parent packages such as Medicine, Surgery, Lab, Radiology, and TIU will also be deleted.

General Security Keys	
MAG PREFETCH	This key allows a user to 'PreFetch' or Queue all images for a patient. This means that all images for a patient that are on the jukebox will be copied from the jukebox to the magnetic server cache.
MAG SYSTEM	Given to person(s) managing VistA Imaging Systems. Required to modify site parameters via the Background Processor or to modify workstation parameters via the MAGSYS application. Also enables the display of DICOM header data for radiology images on Clinical Display workstations.
MAG VIX ADMIN	This key grants access to the VIX transaction log. This key should be assigned to VIX administrators. For more information, see the <i>VIX Administrator's Guide</i> .

3.6.2 Security Keys for Clinical Display

The following keys are used for display of images and should be limited to appropriate personnel:

Display-related Security Keys	
MAG RAD SETTINGS	User can edit the CT Presets in the Clinical Imaging Display Radiology Viewer window.
MAG ROI	User can print (single or multiple) images or copy images without having to enter an electronic signature. This key should be assigned only to the HIMS Release of Information Officer.
MAGDISP ADMIN	User can display administrative images/documents.
MAGDISP CLIN	User can display clinical images/documents.
MAG EDIT	The MAG EDIT key is used to correct an image field when an index field is incorrect or incomplete, such as correcting a wrong specialty that was selected. Only users assigned the MAG EDIT key can edit an image. The MAG EDIT key is also required to access the QA Review Utility when performing quality assurance reviews of the scanned images. Only the Chief, HIM or authorized designated personnel (e.g., VistA Imaging Coordinator, Scanning Supervisor) should be assigned this key.

Display-related Security Keys	
MAG PAT PHOTO ONLY	User can view only the patient photo.
MAG QA REVIEW	User can access QA Review and QA Review Report from Clinical Display Utilities Menu.
MAG REVIEW NCAT	User can view NCAT reports.
MAG VIEW DOD IMAGES	In Patch 72 and 93 versions of Clinical Display, users must have this key to display DoD images. In newer versions of Clinical Display, this key is not checked.

3.6.3 Security Keys for Clinical Capture

Note: If the 'CAPTURE KEYS' site parameter has been initialized, the following keys will need to be assigned appropriately.

Capture-related Security Keys	
MAG CAPTURE	Allow capture of images without an associated specialty (i.e. 'NONE' on the Imaging Capture configuration window).
MAG NOTE EFILE	User can electronically file notes without an electronic signature from the Imaging Capture workstation.
MAGCAP ADMIN	Allow capture of images associated with the 'Admin Document' specialty.
MAGCAP CP	Allow capture of Clinical Procedure images.
MAGCAP LAB	User can capture Laboratory images from the Imaging Capture workstation.
MAGCAP MED C	User can capture Cardiology images from the Imaging Capture workstation.
MAGCAP MED G	User can capture GI images from the Imaging Capture workstation.
MAGCAP MED GEN	User can capture Generic Medicine images from the Imaging Capture workstation.
MAGCAP MED H	User can capture Hematology images from the Imaging Capture workstation.

Capture-related Security Keys	
MAGCAP MED HI	User can capture Internal Medicine / Hematology images from the Imaging Capture workstation.
MAGCAP MED I	User can capture Internal Medicine images from the Imaging Capture workstation.
MAGCAP MED N	User can capture Neurology images from the Imaging Capture workstation.
MAGCAP MED P	User can capture Pulmonary / Endoscopy images from the Imaging Capture workstation.
MAGCAP MED PF	User can capture Pulmonary Function Test images from the Imaging Capture workstation.
MAGCAP MED R	User can capture Rheumatology images from the Imaging Capture workstation.
MAGCAP MED Z	User can capture Consult images from the Imaging Capture workstation.
MAGCAP PHOTOID	User can capture Photo ID images from the Imaging Capture workstation.
MAGCAP RAD	User can capture Radiology images from the Imaging Capture workstation.
MAGCAP SUR	User can capture Surgery images from the Imaging Capture workstation.
MAGCAP TIU	User can capture TIU images from the Imaging Capture workstation.
MAGCAP TRC	User can capture images associated with a "TeleReader Consult" from the Imaging Capture workstation.

3.6.4 Security Keys for VistARad

The following keys are related to VistARad and should be limited to appropriate personnel:

VistARad-related Security Keys	
MAGJ DEMAND ROUTE	User can access VistARad's on-demand routing capability. On-demand routing can be used to manually send exams to remote sites. For more information, refer to the <i>VistA Imaging Routing User Guide</i> .

VistARad-related Security Keys	
MAGJ DEMAND ROUTE DICOM	Allows the user to use the on-demand routing function to queue exam images to be routed to selected remote DICOM destinations. This function only works for sites that have been configured for routing of images. An updated Routing agreement needs to be submitted and approved by the VistA Imaging Group before this function can be used.
MAGJ OVERRIDE ANNOTATIONS	Grants to a radiologist user of VistARad access to the menu option 'Override Annotations' when viewing an exam whose status is 'Complete.' This functionality is detailed in the <i>VistARad User Guide</i> .
MAGJ REMOTE ACCESS CONTROL	Allows a VistARad user to access the Monitored Sites configuration subset of the VIX Configuration settings tab, and to view exam list data in the Monitored Sites tab of the Manager.
MAGJ SEE BAD IMAGES	User can view images in VistARad that are associated with an exam that has failed the "Patient Safety" database checks.
MAGJ STORE IMAGES	Allows VistARad users to save Voxar images as secondary captures to VistA.
MAGJ SYSTEM MANAGER	Allows access to Voxar-related settings in the VistARad Settings dialog. Grants access to additional data in the Imaging Internal Data display window. This functionality is detailed in the <i>VistARad User Guide</i> and <i>Imaging System Installation Guide</i> . Should only be assigned to VistARad administrators. Assigned only to VistARad administrators. Grants access to the Local Site VIX configuration subset of the VIX Configuration tab.
MAGJ SYSTEM USER	Allows a user to create and delete site-level hanging protocols, templates, and image presets associated with the VistARad 'sysAdmin' user.
MAGJ VOXAR COPYIMAGE	Allows VistARad users to copy images using Voxar (Enables the Copy to Clipboard button in the Voxar Reading manager window; refer to Voxar documentation for more information.)
MAGJ VOXAR EXPORTCAPTURE	Allows VistARad users to export images using Voxar (Enables the three Export -related buttons in the Voxar Reading manager window; refer to Voxar documentation for more information.)
MAGJ VOXAR PRINTCOMPOSER	Allows VistARad users to print images using Voxar (Enables the Print Composer button in the Voxar Reading manager window; refer to Voxar documentation for more information.)

3.7 Workstation Hardware

Workstations tend to collect dust inside of the chassis. They should be periodically opened and cleaned. The accumulation of dust can lead to heat damage of workstation components. Only a qualified individual should do further hardware maintenance.

The monitors used with the VistARad diagnostic workstations require periodic calibration to maintain the proper grayscale luminance display characteristics necessary for accurate image quality. A program of maintenance for these monitors should be established and administered by the Biomedical Engineering staff. A calibration/maintenance log should be kept, as such documentation may be required for review by regulatory bodies.

3.8 Changes to DICOM Modalities

When DICOM Modalities are added, or operational parameters are to be modified, see the *VistA Imaging DICOM Gateway User Manual* for the procedures to record the appropriate new values for the various parameters.

3.9 Changes to Windows Servers and Security

Any changes to Image server shares or server security require updates to VistA files. See the *VistA Imaging System Installation Guide* for details.

3.10 Microsoft Patch Installation Guidelines

Sites should use the following guidelines for installing Microsoft patches on VistA Imaging Clinical workstations, DICOM gateways, VistARad workstations, and Imaging file servers.

The nature of the Microsoft patch dictates if it should be installed immediately, after validation, or not at all. For any patch that is installed, use steps detailed in “Procedures for Updates” below.

- **Critical security updates** - Install immediately after they are released from Microsoft.
- **Service Packs** - VistA Imaging will verify with solution vendors that there are no known issues and then will field test the service packs at 4 test sites with monitoring from Silver Spring. The field test will last approximately 2 weeks. If no issues arise, all sites will be instructed to install the service pack.
- **Internet Explorer major version upgrades** (i.e. v5.5 to v6) – Are to be handled the same as service pack updates.
 - Note:** IE-related critical security updates should be installed immediately after they are released from Microsoft.
- **Minor software updates** (media player, etc.) – Do not install unless validated by the VistA Imaging team.

Procedure for updates (critical components)

All updates should be applied methodically to critical Imaging components (file servers, gateways, VistARad Workstations).

1. Ensure that all VistA Imaging components are working properly before installing any updates.
2. Ensure that service packs, non-critical Internet Explorer upgrades, and minor software updates are validated by VistA Imaging (see above).
3. Schedule the installation for a time when system usage is low (in case a reboot is required).
4. Apply each update one at a time.
5. Apply each update to one critical system. Monitor that system for at least 1 day before updating other systems.
6. Do not load updates on all critical systems without first testing on a single system of each type.
7. Report any problems to the National Help Desk immediately.

Notes for Clinical Workstations

For clinical (non-diagnostic) workstations, the following is recommended:

- Microsoft patches should be loaded one at a time, and onto a single workstation only.
- After verifying that the workstation works properly, and that no unexpected issues arise, the patch can be installed on all workstations.

Any problems should be reported to the National Help Desk.

3.11 Parameter Definition

MAG TR ALLOW THIN CLIENT

Sites will be able to configure whether or not TeleReader will be able to access and read images on a workstation that accesses VistA Imaging through a Thin Client.

Chapter 4 Security Software Maintenance

4.1 Security and Anti-virus Considerations

VistA workstations are multi-purpose, multi-function medical systems. These workstations usually enable the users to run all of the VA's application software (including VistA Imaging), the Microsoft Office Suite, e-mail, Internet and other commercial products, as needed by the hospital staff. The workstations should be configured to provide medical information security (as specified by the VA's security staff), and they must have the latest version of anti-virus software protecting them.

Windows security features should be used to restrict user access and protect system and other areas that should not be accessed by users. For additional information, see the *VistA Imaging Installation Guide* and the *VistA Imaging DICOM Gateway Installation Manual*.

VistARad Diagnostic workstations must be excluded from automatic software update/inventory tracking packages, and any client software supporting these cannot be installed. For information about removing SMS, please review the *VistA Imaging Installation Guide*.

Chapter 5 Space, Staffing, and Standard Operating Procedures for VistA Imaging

5.1 Infrastructure Resources

5.1.1 Networking

VistA Imaging Clinical Workstations run best with at least a 100 mb/s network, however they can be run over a 10 mb/s network.

The Background Processor (BP) application operates on a Windows-based PC. It is recommended that it operate on a file server that has a minimum of two gigabytes of RAM.

The VistA Imaging DICOM Gateway requires a hospital network infrastructure having a backbone that will support Ethernet segments with at least 100 megabits per second throughput. It is best to place the servers and Background Processor on the same switch with the gateways.

VistA Imaging VistARad workstations should be on their own separate 1Gb/s network connection to the file servers whenever possible. This is especially important when more than two diagnostic workstations are in use in the radiology department. The VistARad workstations can run acceptably on a 100mb/s network, but speed of image retrieval and display may be compromised.

The VistA Imaging Exchange (VIX) service can be set up on the clustered server used for Imaging shares (recommended) or on a dedicated standalone server. If the VIX is set up on a standalone server, the server should have a 1Gb/s network connection to the Imaging cluster. For more information about the VIX, see the *VistA Imaging VIX Administrator's Guide*.

5.1.2 Space

Each VistA Imaging DICOM Gateway runs on a Windows-based workstation with a monitor having a resolution of 1280x1024 pixels or better. Space is required for the system, its monitor, keyboard and mouse.

The Background Processor runs on a Windows-based file server and requires similar physical space.

The VistARad software runs on a Windows-based workstation using one to four monitors having a resolution sufficient for diagnostic reading. An additional workstation running voice dictation software may be present as well. Allow adequate space for the workstation(s), all monitors, keyboards, pointing devices, and dictation devices. In addition, plan for adequate room cooling and for room lighting that is suitable for diagnostic reading requirements.

5.1.3 Power

It is strongly recommended that the power supply to each VistA Imaging server, jukebox, DICOM Gateway, and Background Processor be safeguarded by means of an **Uninterruptible Power Supply (UPS)**. This will reduce line voltage problems as well as protect against power outages.

5.1.4 Remote Access

In order to allow the VistA Imaging Project Support Staff to gain access to the servers and workstations that are running the VistA Imaging, a copy of either PC-Anywhere (preferred) or Remotely Possible (servers) must be installed on each server or workstation. These should be configured as a *host*. These systems should never be hooked up to a modem.

5.1.5 Security

Remote access must be password protected. Be sure to keep the VistA Imaging Project Support Staff updated when any such passwords are changed.

5.2 Support

5.2.1 IRM Support Staff Requirements

IRM support for VistA Imaging may require one or more staff members, depending on the size of the installation. These staff members must possess knowledge of VistA, Microsoft Windows, networking, and troubleshooting problems with Windows and TCP/IP. These staff members will need administrator privileges and should have a good foundation in Windows to cover troubleshooting, permissions and set-up. Network support will be needed to troubleshoot and maintain routing, wiring and configurations where packet filtering is in use.

Team members should be comfortable with the following areas:

- *User Manager* for Domains
- Setting permissions
- Shares
- *Server Manager* for setting up shares
- *Event Viewer*
- *Ping, TraceRT, NetStat, and DICOM_Echo*
- *TCP/IP troubleshooting techniques*

These staff members will be responsible for supporting Windows-based magnetic and jukebox servers, installing VistA Imaging patches, correcting information in VistA relating to the relationships between patients and images, installing workstations and workstation capture devices, and managing the Background Processor and DICOM gateways. This staff member is responsible for assigning Imaging keys and menus to the users.

VistA package support staff should cover the installation of Imaging KIDS patches and issues like translation tables and journaling. In addition, a staff member with experience in M should be available to assist in editing global variables and using FileMan to make corrections as necessary to correct situations such as the incorrect assignment of an image to a patient.

5.2.2 Biomedical Engineering Support Staff Requirements

Someone experienced in Biomedical Engineering and/or network support will be needed to install and troubleshoot modalities, display and capture workstations, capture devices, network and server systems, and to calibrate diagnostic workstation monitors. The amount of time required for these duties will vary with the size and specifics of the installation.

This staff will be responsible for ensuring that the modalities maintain their connections to the network and are able to communicate with the gateway systems. These staff members should be able to monitor modality traffic and to distribute modality traffic over different gateway processors, depending upon local traffic conditions and circumstances.

5.2.3 ADPAC Staff Requirements for Support for All Medical Services

These staff members will need to know how to use, teach, and support the VistA Imaging system. They should have a close relationship with the IRM staff so that problems may be reported and so that they may be of assistance in the resolution of these problems. The ADPACs will need to assist in implementing and customizing the VistA Imaging System for various specialties. They will need to trouble-shoot issues related to how VistA Imaging System fits into the practice of medicine. They will be the first line of support in the use of the VistA Imaging package and will need to assist the end-users. ADPACs should be able to train key users who can then, in turn, train other users on the VistA Imaging System.

The ADPACs will be responsible for being key advocates of the VistA Imaging system. It is essential that the ADPACs be proactive people. They will need to “walk the hospital” in the morning to be sure that users are not having problems. They will need to check on the modalities to ensure that they are working properly. These staff members may also be called upon to assist in correcting image header information, so that images are properly assigned to the right patients. The correcting of image headers is an event that does not happen often but one that may occur when the modality does not have an automatic worklist capability but requires end-user interaction to provide the patient name, social security number, and radiology accession number.

5.3 Daily Activities

Standard practices should be followed, including doing complete backups prior to installation of any new software or patches. For every processor in the suite of equipment for the VistA Imaging system, documentation should be maintained indicating what versions of which software are running and when new versions or patches are installed. In addition, this documentation should include information on the dates of installation, and who participated in the installation of software, patches or updates, and any unusual occurrences at the time of installation. Records should be kept of any problems that occur at the site, their cause and resolution.

5.3.1 IRM Morning Routine

Each morning the standard operating procedure should be to perform the tasks listed below in order to ensure the normal daily operation of the system.

5.3.1.1 Check the Imaging Network

Use Ping and other utilities, such as browsing, to ensure that all servers, gateways and modalities are reachable through the network.

5.3.1.2 Check the Jukebox for Sufficient Platters in the Write Path

Physically check the jukebox and its console to see which platters are currently loaded. Ensure that there are sufficient disks loaded to cover the day's operations and that there are new ones available to be used when needed.

5.3.1.3 Check Current Write Locations for Sufficient Disk Space

Check the disk space on the servers and gateways. If images are accumulating on the Image Gateway and are not being passed to the VistA Imaging Servers, check for gateway problems. Correct any header information to associate images with the correct patient and allow the gateway to get the images in question moved to the VistA Imaging Servers.

5.3.1.4 Check the Event Viewer Trap on Imaging Network

Use the *Event Viewer* (under Administrative Tools) to display alerts. These logs may be filtered to show only warnings and alerts. It is a good practice to periodically save these logs to removable media and flush the logs. This will keep disk space usage to a minimum and still allow for old logs to be viewed.

5.3.1.5 Check the Imaging Background Processor

Failed queues can be noted in the Queue Activity window in the BP Queue Processor window. Active and failed queue status, system wide, can be accessed from the menu option: View|Purge Re-queue by type.

Use the Queue Manager on the Background Processor to check for details about failed queues. The Queue Manager should be invoked by using the menu on the BP Queue Processor window.

To check the failed queues, select **Edit | QueueManager** and browse each queue type. This will give a list of the various failed queues by way of the error message.

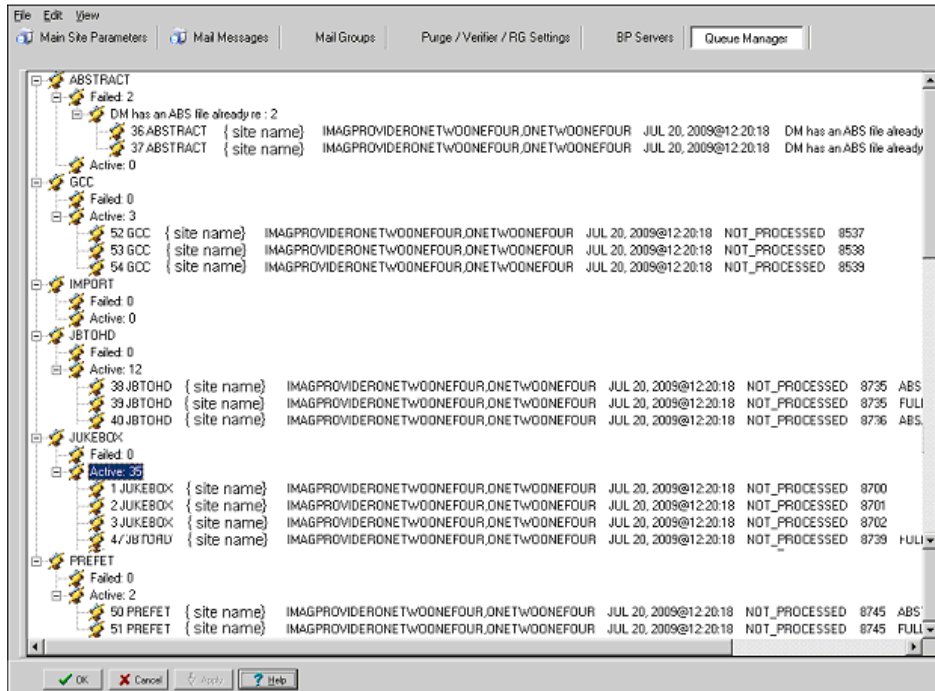

This information will provide some insight as to what processes are failing and why. Right-clicking in the message or group level provides a menu to Re-Queue or Purge Queue.

5.3.1.6 Check that the DICOM Image and Text Gateways are Up and Functioning

Look for any error messages in the open windows. For each processor, make sure that there are windows open for listening and accepting images from those modalities that are assigned to that processor. MSM must be up and running on all gateways, as well as the display windows for the various monitoring sessions. If any of these are not running, restart them. Be sure that the VistA HIS is running.

5.3.1.7 Check that the DICOM Image Gateway Modalities are Sending Images

The ADPACs and end-users will generally let the IRM know if the modalities are not able to send or store images, however, it is good practice to check on this at the beginning of the day. Check the queue lengths.

5.3.1.8 Review The Image_In Directory for Incomplete DCM Files

Review the entries in the Dicom\Image_In directory for any files with “_incomplete” appended to the file name. These are incomplete files received by a modality or a PACS interface that the DICOM image gateway could not process. Research the files to see if the entity resent them at a later time or the images were never received. These files will automatically be purged after one hour.

On the main hospital system, check to see if the DICOM FAILED IMAGES file (#2006.575) has entries that need correcting. If there are “failed image files”, work with the ADPACs and end-users to correct the information in the image headers and to associate these image files with the correct patients.

5.3.1.9 Review the MUMPS Error Traps

Review the MUMPS error traps on all of the DICOM Gateways and the main hospital system. Look for error messages related to the imaging routines (MAG*). If there are any errors that cannot be resolved by the local IRM staff, log a Remedy call so the VistA Imaging support staff may assist in their resolution. However, local IRM staff can easily address most error conditions.

5.4 Maintenance

Do an incremental tape backup of all active Imaging RAID shares (for new images captured) or update copy media if doing media copies on the jukebox. Active RAID shares can be isolated by RAID group configuration.

5.5 Weekly Activities

A RAID Group is a group of one-to-many shares that will be recognized as a unit within the Imaging storage network. Its purpose is to reduce the number of active storage shares in order to facilitate quicker tape backups (both incremental and full). Newly acquired images are distributed evenly among all the shares within a RAID Group.

Do a full backup of active Imaging RAID shares using the procedures in place at your site. For additional information, refer to Appendixes B and C in the *VistA Imaging Installation Guide*.

5.6 Other Periodic Activities

Support for the VistA Imaging systems includes activities for support of Windows-based servers and the VistA System. Backups should be made for all systems. Current patches should be loaded for VistA. Service Packs for Windows and updates to the VistA Imaging software should be installed as they are released.

- Use the BP Queue Manager to re-queue failed entries and to purge the queues.
- Use the MagUtility program to maintain RAID and jukebox storage resources. For details, see the *Storage Utilities User Manual*.
- Review the monthly Image Site Usage mail message to ensure all workstations have latest software installed.
- Before installing any new software or patches, first do a full backup, including the Registry files.

- For the VistARad diagnostic workstation monitors, calibration should be checked on a scheduled basis, at least monthly—more frequently is preferred. Consult the recommendations of the monitor manufacturer. Re-calibration should be performed whenever the calibration check reveals a need to do so. Also, whenever any part of the monitor/video driver hardware configuration is altered, a new calibration must be performed. Examples of configuration changes include: re-setting brightness or contrast controls; removing or replacing a monitor; removing or replacing a video board; replacing the system PC; etc.

5.7 Scheduled Down Time for VistA Servers

During a VistA System outage, DICOM Gateways will continue to provide modality worklist functionality and to capture images that are temporarily stored on the gateway. This is important to allow the radiology department to continue to perform studies. If you anticipate that the VistA System must be down, it is best to take the following steps:

- Perform all DICOM fixes before the VistA System goes down. This will free the maximum space for temporary image storage.

During the outage, watch the gateways to be sure they still have adequate space to store images.

Chapter 6 Routine Descriptions

The Food and Drug Administration classifies this software as a medical device. As such, it may not be changed in any way. Modifications to this software may result in an adulterated medical device under 21CFR820, the use of which is considered to be a violation of US Federal Statutes.

VA Policy states the following:

Those components of a national package (routines, data dictionaries, options, protocols, GUI components, etc.) that implement a controlled procedure, contain a controlled or strictly defined interface or report data to a database external to the local facility, must not be altered except by the Office of Information (OI) Technical Services (TS) staff. A controlled procedure is one that implements requirements that are mandated or governed by law or VA (Department of Veterans Affairs) directive or is subject to governing financial management standards of the Federal Government and VA or that is regulated by oversight groups such as the JCAHO or FDA. A controlled or strictly defined interface is one that adheres to a specific industry standard, will adversely affect a package and/or render the package inoperable if modified or deleted. For national software that is subject to FDA oversight, only the holder of the premarketing clearance (510(k)) is allowed to modify code for the medical device. The holder of a premarketing clearance is restricted to specifically designated TS staff that are located at the registered manufacturing site and operating in the designated production environment.

All routines, files and fields of the VistA Imaging package may not be altered except by the OI Technical Services (TS) staff. This software is regulated by the FDA and implements controlled procedures.

6.1 VistA Imaging Routines on the VistA Hospital Information System

6.1.1 Build Checksums

The Calculate and Show Checksum Values [XTSUMBLD-CHECK] menu option can be used as shown below to display a list of checksums for a specified build (KIDS file).

```
Select Programmer Options Option: CALculate and Show Checksum Values

This option determines the current Old (CHECK^XTSUMBLD) or New (CHECK1^XTSUMBLD)
logic checksum of selected routine(s).

    Select one of the following:

        1      Old
        2      New

New or Old Checksums: New// 1 Old

This option determines the current checksum of selected routine(s).
The Checksum of the routine is determined as follows:

1. Any comment line with a single semi-colon is presumed to be
   followed by comments and only the line tag will be included.

2. Line 2 will be excluded from the count.

3. The total value of the routine is determined (excluding
   exceptions noted above) by multiplying the ASCII value of each
   character by its position on the line being checked.

    Select one of the following:

        P      Package
        B      Build

Build from: Build

This will check the routines from a BUILD file.

Select BUILD NAME: MAG*3.0*65      IMAGING

MAGDCRP  value = 5933815
MAGDCTP  value = 6346229
MAGJEX1  value = 25464807
MAGJEX1A value = 24747878
MAGJEX1B value = 11594499
MAGJLST1 value = 14901163
MAGJMN1  value = 15056848
MAGJUTL1 value = 16248767
MAGJUTL2 value = 15423285
MAGJUTL3 value = 13396263
MAGJUTL5 value = 15726176
done
```

6.1.2 Package Checksums

The Calculate and Show Checksum Values [XTSUMBLD-CHECK] menu option can be used as shown below to display a list of checksums for all routines in the Imaging Package. Imaging routines are under the MAG namespace.

```

Select Programmer Options Option:  CALCulate and Show Checksum Values

This option determines the current Old (CHECK^XTSUMBLD) or New (CHECK1^XTSUMBLD)
  logic checksum of selected routine(s).

  Select one of the following:

      1      Old
      2      New

New or Old Checksums: New// 2 New
New CheckSum CHECK1^XTSUMBLD:

This option determines the current checksum of selected routine(s).
The Checksum of the routine is determined as follows:

1. Any comment line with a single semi-colon is presumed to be
   followed by comments and only the line tag will be included.
2. Line 2 will be excluded from the count.
3. The total value of the routine is determined (excluding
   exceptions noted above) by multiplying the ASCII value of each
   character by its position on the line and position of the line in
   the routine being checked.

  Select one of the following:

      P      Package
      B      Build

Build from: Package

All Routines? No => No

Routine: MAG*
Routine: <enter>
282 routines

MAG7RS    value = 54368283
MAG7RSD   value = 12010159
MAG7RSO   value = 6903355
MAG7RSR   value = 7799977
MAG7UDR   value = 7350925
MAG7UFO   value = 6573900
MAG7UM    value = 23964940
MAG7UP    value = 34875703
MAGBAPI   value = 74386027
MAGBAPIP  value = 9049823
MAGBRTE3  value = 17206043
...
...
done

```

6.1.3 Routine Descriptions

To obtain a brief description for all VistA Imaging routines, use the First Line Routine Print [XU FIRST LINE PRINT] menu option. Including the second line in the report will show which patches have made changes to the routine. This menu option is part of Programmer Options [XUPROG] under sub-menu Routine Tools [XUPR-ROUTINE-TOOLS].

VistA Imaging routines are under the MAG namespace. The following is an example:

```
Select OPTION NAME: PROGRAMMER OPTIONS XUPROG Programmer Options

Select Programmer Options Option: ROUTINE Tools

Select Routine Tools Option: FIRST Line Routine Print

PRINTS FIRST LINES

routine(s) ? > MAG*
searching directory ...
routine(s) ? >

(A)lpha, (D)ate ,(P)atched, OR (S)ize ORDER: A//
Include line 2? NO//
DEVICE: HOME//
```

6.2 DICOM Gateway Routines

The VistA Imaging DICOM Gateway requires a number of M routines. Most of these are part of the VistA Imaging package. However, because the DICOM gateways run as standalone workstations, they must include some routines from other packages. A few routines must run in the manager UCI.

6.2.1 Checksums of VistA Imaging DICOM Gateway Routines

The following listing reflects the VistA Imaging M routines that reside on the VistA Imaging DICOM gateway system.

Routine	Checksum	Routine	Checksum	Routine	Checksum
MAG7UP	35026432	MAGBRTP1	30941600	MAGDACU2	7237662
MAGBRTA4	73323436	MAGDACP1	64531548	MAGDACU3	8904229
MAGBRTA5	73969329	MAGDACP2	5612621	MAGDACW1	48007177
MAGBRTA6	12479695	MAGDACP3	46008004	MAGDACW2	26199743
MAGBRTB1	26772420	MAGDACR1	33293963	MAGDAIR1	174066539
MAGBRTB2	62448973	MAGDACR2	16258693	MAGDAIR2	92683924
MAGBRTB3	21639509	MAGDACR3	55462381	MAGDAIR3	110325747
MAGBRTB4	29268889	MAGDACU	8269447	MAGDAIR4	62752145
MAGBRTK	20097310	MAGDACU0	10807003	MAGDAIR5	176403451
MAGBRTLRL	10848658	MAGDACU1	38544788	MAGDAIR6	56732455

Routine	Checksum
MAGDAIRA	21720426
MAGDAIRC	87074830
MAGDAIRD	21354401
MAGDAIRL	60007084
MAGDAIRM	117531807
MAGDAIRP	31922397
MAGDAIRR	91423560
MAGDAIRS	124778594
MAGDAIRU	35105501
MAGDAIRW	35105501
MAGDAUD1	21787487
MAGDAUD2	11632745
MAGDAUD3	4475591
MAGDBB	51899412
MAGDBB2	22088679
MAGDCIGL	14772888
MAGDCIRL	19614608
MAGDCMPE	15269197
MAGDCST1	77264274
MAGDCST2	32420227
MAGDCST3	12356196
MAGDCST4	39520710
MAGDCST5	11640174
MAGDCST6	21003965
MAGDDEL	4367093
MAGDDEL1	7861418
MAGDDEL2	31000923
MAGDDEL3	7544616
MAGDDR0	53556787
MAGDDR1	48401978
MAGDDR2	32387608
MAGDDR2A	72483962

Routine	Checksum
MAGDDR3	42865716
MAGDDR7	19337667
MAGDDW0	18480829
MAGDDW1	33395508
MAGDDW2	45331856
MAGDDW3	35962080
MAGDDW4	73618612
MAGDECHO	9429115
MAGDEXC1	41469390
MAGDEXC2	53045931
MAGDFCNS	77913878
MAGDFND0	23608364
MAGDFND1	17372953
MAGDFND2	84247727
MAGDFND3	87847559
MAGDFND4	31058834
MAGDFND5	11262447
MAGDFND9	5028212
MAGDGEX1	76377251
MAGDGEX2	25589452
MAGDGLC	36322745
MAGDHR5	3902302
MAGDHR9	7550129
MAGDHRC	82233547
MAGDHRC0	7768511
MAGDHRC1	32850852
MAGDHRC2	20185184
MAGDHRC3	113328494
MAGDHRC4	137481394
MAGDHRC5	63082234
MAGDHRC6	28767993
MAGDHRC7	14399552

Routine	Checksum
MAGDHRCP	40374302
MAGDHRCU	4706071
MAGDIR3	32120170
MAGDIR4A	9771049
MAGDIR5	7586177
MAGDIR6	87229193
MAGDIR6A	13107192
MAGDIR6B	19607847
MAGDIR6C	38621123
MAGDIR6D	24854094
MAGDIR6E	23447535
MAGDIR6F	19332518
MAGDIR6G	8628791
MAGDIR7	4535461
MAGDIR71	69036960
MAGDIR72	4436051
MAGDIR73	5722083
MAGDIR74	6275398
MAGDIR75	49544197
MAGDIR7C	86128520
MAGDIR7D	16648443
MAGDIR7F	32599821
MAGDIR7G	9410773
MAGDIR7T	38613863
MAGDIRDE	8549629
MAGDIW2A	40090331
MAGDIW3	20270812
MAGDIW3A	86768833
MAGDIW3B	40511860
MAGDIW3C	14730954
MAGDIW4	20553778
MAGDIW6	33599253

Routine	Checksum
MAGDIWB0	5743080
MAGDIWB1	70936816
MAGDIWB2	87452809
MAGDIWB5	94186343
MAGDIWB7	16107756
MAGDIWBA	81638859
MAGDIWBB	69878204
MAGDIWBC	86128746
MAGDIWBD	21590116
MAGDIX	5690876
MAGDIX1	28030316
MAGDLOGI	18187840
MAGDLOGN	69219103
MAGDM2MB	16447591
MAGDMENA	54060598
MAGDMENL	7146964
MAGDMENO	53380682
MAGDMENU	51431162
MAGDMFB	47598711
MAGDMFB1	81982222
MAGDMFB2	48221936
MAGDMFB3	41071819
MAGDMFB4	15205941
MAGDMFB5	25775790
MAGDMFB6	19405158
MAGDMFB7	26178773
MAGDMFB8	13147824
MAGDMFB9	25588255
MAGDMFBA	16186541
MAGDMFBB	52340245
MAGDMFBC	35544731
MAGDMFBD	37898955

Routine	Checksum
MAGDMFBE	97858231
MAGDMFBI	23675432
MAGDMFBM	86611155
MAGDMFBN	5306612
MAGDMFBP	17921307
MAGDMFBS	49061654
MAGDMFBT	18607447
MAGDMFBW	44248405
MAGDMFCC	25084521
MAGDMFIC	51798367
MAGDMLGV	73643867
MAGDMLOG	31647401
MAGDMMSG	53806690
MAGDMPPC	8533330
MAGDMSGT	9623232
MAGDOS	5971106
MAGDQR15	16568428
MAGDQRU0	5735145
MAGDQUE0	30499869
MAGDQUE1	29292136
MAGDQUE2	21951411
MAGDQUE3	24604791
MAGDQUE4	27764385
MAGDRPC0	4265561
MAGDSSD	4287052
MAGDSTA1	6477867
MAGDSTAT	68354778
MAGDSTRT	52825843
MAGDTCP	14101280
MAGDTCP1	6918159
MAGDTCP2	69855871
MAGDTCP3	27934440

Routine	Checksum
MAGDTGA	10117098
MAGDTLOG	5398596
MAGDUID1	19789188
MAGDUID2	3785565
MAGDUID4	6700589
MAGDVRSN	21494340
MAGDWLKL	3291181
MAGDWLP2	27620920
MAGDWLP3	3990165
MAGDWLPA	76434838
MAGDWLPB	54570103
MAGDWLPC	53817899
MAGDWLU	16190289
MAGDWLU0	4339594
MAGDWLU1	38702922
MAGDWLU2	44762496
MAGDWLU3	96198773
MAGDWLU4	5869877
MAGM2VC	57774863
MAGM2VCU	89722252
MAGOSDIR	17707114
MAGOSFIL	38021742
MAGOSMSC	50373718
MAGOSTCP	34311495
MAGUE	75297995

6.2.2 DICOM Gateway Routine Descriptions

The MUMPS routines on the DICOM Gateway can be listed using the FIRST ROUTINE LINE DISPLAY routine (%RFIRST). The following is an example of steps required to use the %RFIRST routine to list Imaging routines.

```

>D ^%RFIRST

                MSM - First Line Display Utility
                07-APR-00  2:09 PM

Routine selector:  MAG*

                253 routines Selected

Routine selector:

Enter output device <4>:  <CR>

```

See the previous section for the checksums of the distributed routines.

6.2.3 Kernel RPC Broker Routines

Two RPC Broker routines are incorporated into the DICOM Gateway software. See the *VistA Imaging Security Guide* for more information.

6.3 Non-M Routines Distributed as Executable Files

Executable, DLL and other supporting files, which are distributed, include capture device-specific imaging software and executable imaging software. The routine listing below is by function.

6.3.1 Clinical Workstation Files

The following tables list files installed on a Clinical (Display or Capture) workstation.

C:\Program Files\VistA\Imaging – Main Clinical Display & Capture files		
ABSTRTGA.EXE	HSUMM.TXT	MagScanFilm.EXE
ActiveMILDefault.exe	ImagDEMO.DAT	MagSCREEN.HLP
Annotation Editor Help.cnt	mag308.ini	Magsys.cnt
ANNOTATION EDITOR HELP.HLP	MagDemos.TXT	MAGSYS.EXE
demo12.txt	MagEKGView.hlp	Magsys.hlp
DEMO1802.TXT	MagImageCapture.exe	MAGSYS.INI
DEMO2230.TXT	MAGIMAGEDELETE.HLP	MagSysKey.CNT
demo3.txt	MagImageDisplay.exe	MAGSYSKEY.HLP
DEMO446.TXT	magimaging.cnt	MagTeleReader.exe
demolist.txt	MAGIMAGING.HLP	magupdate.ini
DocScan.cnt	MagMinibld.EXE	magwrks.CNT
DOCSCAN.HLP	magPermissions.bat	MAGWRKS.EXE
ERRLOOK.EXE	MagScan150N.BAT	Magwrks.hlp
ERRLOOK.HLP	MagScan75N.BAT	MEANSTEST.HLP
FRAMGRAB.EXE	MagScanFile.EXE	SCNAPI.DLL
<p><i>The main application files are shown in bold. Files ending in '.cnt' and '.hlp' are contents for help files and help files.</i></p>		

c:\Program Files\VistA\Imaging\Bmp – Icons used by Clinical Display & Capture		
abscline.bmp	DoD_PDF.bmp	magrtf.bmp
absekg.bmp	DoD_RTF.bmp	magtext.bmp
ABSERROR.BMP	DoD_Unavailable.bmp	magwav.bmp
absjbox.bmp	DoD_Word.bmp	MotionVideo.bmp
abspacg.bmp	ImageQA.bmp	Magblack.bmp
abspaci.bmp	InternalError.bmp	magdoc.bmp
absremote.bmp	FileOpenError.bmp	maghtml.bmp
BLANK.BMP	FullResFileNotFound.bmp	magpdf.bmp
Blank.tga	FullResFileOpenError.bmp	MotionVideoAbs.bmp
	ImageUnavailable.bmp	

c:\Program Files\Vista\Imaging\Bmp – Icons used by Clinical Display & Capture		
CAPTURE.BMP	jboffln.abs	NOTEXIST.BMP
DoD_ASCII.bmp	JBOFFLN.bmp	PRECAP.BMP
DoD_Doc.bmp	JBOFFLN.tga	magBlockedImage.bmp
DoD_JPG.bmp	magavi.bmp	magsensitive.bmp
DoD_NCAT.bmp		

C:\Program Files\Vista\Imaging\Image – Sample images (obsolete)		
<i>These files are no longer distributed as of Patch 8, but may be present on older workstations. These files are no longer used.</i>		
BLACKBOX.TGA	DILB3.BMP	Samples.txt

C:\Program Files\Vista\Imaging\help\client\index.htm – online help files
<i>All files in this directory are help files for the Vista Imaging Display and Capture clients.</i>

C:\Program Files\Vista\Imaging\Lib		
ACE.dll	GEAR32PO.OCX	igMED15a.ocx
AGM.dll	ig_cmyk_profile.icm	igmed15d.dll
BIB.dll	ig_rgb_profile.icm	igmed32s.dll
BIBUtils.dll	igART15a.ocx	IGMed32x.ocx
DL70ACE.dll	igartgui15d.dll	igmult15d.dll
DL70AdobeXMP.dll	igCORE15a.ocx	igMULTIMEDIA15a.ocx
DL70AGM.dll	igCORE15d.dll	igPDF15a.ocx
DL70ARE.dll	igDISPLAY15a.ocx	igPROCESSING15a.ocx
DL70AXE8SharedExpat.dll	igDLGS15a.ocx	igVECT15a.ocx
DL70AXE16SharedExpat.dll	igEFFECTS15a.ocx	igVIEW15a.ocx
DL70BIB.dll	igFORMATS15a.ocx	JP2KLib.dll
DL70BIBUtils.dll	igguidlg15a.dll	kdu_v52R.dll
DL70CoolType.dll	igguiwin15a.dll	MagAnnOCX.ocx
DL70JP2KLib.dll	igJPEG2K15a.ocx	MagAnnTool.dll
DL70PDFL.dll	igLZW15a.ocx	nserver.dll

C:\Program Files\Vista\Imaging\Lib\Accusoft16.2		
ACE.dll	ig_cmyk_profile.icm	igMED16a.ocx
AGM.dll	ig_rgb_profile.icm	igMULTIMEDIA16a.ocx
BIB.dll	igART16a.ocx	igPDF16a.ocx
BIBUtils.dll	igartgui16d.dll	igPROCESSING16a.ocx
DL81AdobeXMP.dll	igCORE16a.ocx	igVECT16a.ocx
DL81AGM.dll	igDISPLAY16a.ocx	igVIEW16a.ocx
DL81ARE.dll	igDLGS16a.ocx	JP2KLib.dll
DL81AXE8SharedExpat.dll	igEFFECTS16a.ocx	kdu_v52R.dll
DL81BIB.dll	igFORMATS16a.ocx	mfc71.dll
DL81BIBUtils.dll	igguidlg16a.dll	msvc71.dll
DL81CoolType.dll	igguiwin16a.dll	msvcr71.dll
DL81JP2KLib.dll	igJPEG2K16a.ocx	nserver.dll
DL81PDFL.dll	igLZW16a.ocx	

C:\Program Files\Vista\Imaging\Lib\Resource\PDF\CMap – PDF support files		
78-EUC-H	B5pc-H	KSCms-UHC-H
78-EUC-V	B5pc-UCS2	KSCms-UHC-HW-H
78-H	B5pc-UCS2C	KSCms-UHC-HW-V
78-RKSJ-H	B5pc-V	KSCms-UHC-UCS2
78-RKSJ-V	CNS-EUC-H	KSCms-UHC-V
78-V	CNS-EUC-V	KSCpc-EUC-H
78ms-RKSJ-H	CNS1-H	KSCpc-EUC-UCS2
78ms-RKSJ-V	CNS1-V	KSCpc-EUC-UCS2C
83pv-RKSJ-H	CNS2-H	KSCpc-EUC-V
90ms-RKSJ-H	CNS2-V	NWP-H
90ms-RKSJ-UCS2	ETen-B5-H	NWP-V
90ms-RKSJ-V	ETen-B5-UCS2	RKSJ-H
90msp-RKSJ-H	ETen-B5-V	RKSJ-V
90msp-RKSJ-V	ETenms-B5-H	Roman
90pv-RKSJ-H	ETenms-B5-V	UCS2-90ms-RKSJ
90pv-RKSJ-UCS2	ETHK-B5-H	UCS2-90pv-RKSJ
90pv-RKSJ-UCS2C	ETHK-B5-V	UCS2-B5pc
90pv-RKSJ-V	EUC-H	UCS2-ETen-B5
Add-H	EUC-V	UCS2-GBK-EUC
Add-RKSJ-H	Ext-H	UCS2-GBpc-EUC
Add-RKSJ-V	Ext-RKSJ-H	UCS2-KSCms-UHC
Add-V	Ext-RKSJ-V	UCS2-KSCpc-EUC
Adobe-CNS1-0	Ext-V	UniCNS-UCS2-H
Adobe-CNS1-1	GB-EUC-H	UniCNS-UCS2-V

C:\Program Files\Vista\Imaging\Lib\Resource\PDF\CMap – PDF support files		
Adobe-CNS1-2	GB-EUC-V	UniCNS-UTF16-H
Adobe-CNS1-3	GB-H	UniCNS-UTF16-V
Adobe-CNS1-4	GB-V	UniCNS-UTF32-H
Adobe-CNS1-B5pc	GBK-EUC-H	UniCNS-UTF32-V
Adobe-CNS1-ETen-B5	GBK-EUC-UCS2	UniCNS-UTF8-H
Adobe-CNS1-H-CID	GBK-EUC-V	UniCNS-UTF8-V
Adobe-CNS1-H-Host	GBK2K-H	UniGB-UCS2-H
Adobe-CNS1-H-Mac	GBK2K-V	UniGB-UCS2-V
Adobe-CNS1-UCS2	GBKp-EUC-H	UniGB-UTF16-H
Adobe-GB1-0	GBKp-EUC-V	UniGB-UTF16-V
Adobe-GB1-1	GBpc-EUC-H	UniGB-UTF32-H
Adobe-GB1-2	GBpc-EUC-UCS2	UniGB-UTF32-V
Adobe-GB1-3	GBpc-EUC-UCS2C	UniGB-UTF8-H
Adobe-GB1-4	GBpc-EUC-V	UniGB-UTF8-V
Adobe-GB1-GBK-EUC	GBT-EUC-H	UniHojo-UCS2-H
Adobe-GB1-GBpc-EUC	GBT-EUC-V	UniHojo-UCS2-V
Adobe-GB1-H-CID	GBT-H	UniHojo-UTF16-H
Adobe-GB1-H-Host	GBT-V	UniHojo-UTF16-V
Adobe-GB1-H-Mac	GBTpc-EUC-H	UniHojo-UTF32-H
Adobe-GB1-UCS2	GBTpc-EUC-V	UniHojo-UTF32-V
Adobe-Japan1-0	H	UniHojo-UTF8-H
Adobe-Japan1-1	Hankaku	UniHojo-UTF8-V
Adobe-Japan1-2	Hiragana	UniJIS-UCS2-H
Adobe-Japan1-3	HKdla-B5-H	UniJIS-UCS2-HW-H
Adobe-Japan1-4	HKdla-B5-V	UniJIS-UCS2-HW-V
Adobe-Japan1-5	HKdlb-B5-H	UniJIS-UCS2-V
Adobe-Japan1-6	HKdlb-B5-V	UniJIS-UTF16-H
Adobe-Japan1-90ms-RKSJ	HKgccs-B5-H	UniJIS-UTF16-V
Adobe-Japan1-90pv-RKSJ	HKgccs-B5-V	UniJIS-UTF32-H
Adobe-Japan1-H-CID	HKm314-B5-H	UniJIS-UTF32-V
Adobe-Japan1-H-Host	HKm314-B5-V	UniJIS-UTF8-H
Adobe-Japan1-H-Mac	HKm471-B5-H	UniJIS-UTF8-V
Adobe-Japan1-PS-H	HKm471-B5-V	UniJISPro-UCS2-HW-V
Adobe-Japan1-PS-V	HKscs-B5-H	UniJISPro-UCS2-V
Adobe-Japan1-UCS2	HKscs-B5-V	UniJISPro-UTF8-V
Adobe-Japan2-0	Hojo-EUC-H	UniJISX0213-UTF32-H
Adobe-Korea1-0	Hojo-EUC-V	UniJISX0213-UTF32-V
Adobe-Korea1-1	Hojo-H	UniKS-UCS2-H
Adobe-Korea1-2	Hojo-V	UniKS-UCS2-V
Adobe-Korea1-H-CID	Identity-H	UniKS-UTF16-H
Adobe-Korea1-H-Host	Identity-V	UniKS-UTF16-V
Adobe-Korea1-H-Mac	Katakana	UniKS-UTF32-H
Adobe-Korea1-KSCms-UHC	KSC-EUC-H	UniKS-UTF32-V

C:\Program Files\Vista\Imaging\Lib\Resource\PDF\CMap – PDF support files		
Adobe-Korea1-KSCpc-EUC	KSC-EUC-V	UniKS-UTF8-H
Adobe-Korea1-UCS2	KSC-H	UniKS-UTF8-V
AdobeFnt09.lst	KSC-Johab-H	V
B5-H	KSC-Johab-V	vssver2.scc
B5-V	KSC-V	WP-Symbol

C:\Program Files\Vista\Imaging\Lib\Resource\PDF\Font – PDF support files		
AdobeFnt09.lst	zx_____.mmm	zy_____.mmm
vssver2.scc		

C:\Program Files\Vista\Imaging\Muse – MUSE API support files		
Bti.ini	lfmac80n.dll	LTKRN80N.DLL
BUTIL.EXE	lfmac80w.dll	LTKRN80W.DLL
ccalc32.dll	lfmsp80n.dll	LTTHK80W.DLL
DCMUTL32.DLL	lfmsp80w.dll	LTTWN80N.DLL
lfavi80n.dll	lfpcd80n.dll	LTTWN80W.DLL
lfavi80w.dll	lfpcd80w.dll	LTWND80N.DLL
lfawd80n.dll	lfpct80n.dll	LTWND80W.DLL
lfbmp80n.dll	lfpct80w.dll	museapi.dll
lfbmp80w.dll	lfpcx80n.dll	museapi5a.dll
lfc80n.dll	lfpcx80w.dll	MUSEAPI5e.dll
lfc80w.dll	lfpng80n.dll	MUSEAPI7.dll
lfcmp80n.dll	lfpng80w.dll	museapiFAKE.dll (for non-MUSE sites)
lfcmp80w.dll	lfras80n.dll	NWLOCALE.DLL
lfdic80n.dll	lfras80w.dll	PRINTLIB.DLL
lfdic80w.dll	lftga80n.dll	Tabctl32.ocx
lfeps80n.dll	lftga80w.dll	table32.dll
lfeps80w.dll	lftif80n.dll	W3AIF103.DLL
lffax80n.dll	lftif80w.dll	W3BIF106.DLL
lffax80w.dll	lffwx80n.dll	W3BTRV7.DLL
lffpx7.dll	lffwx80w.dll	W3CRS106.DLL
lffpx80n.dll	lffwmf80n.dll	

C:\Program Files\VistA\Imaging\Muse – MUSE API support files		
lfgif80n.dll	lfwmf80w.dll	W3MIF109.DLL
lfgif80w.dll	lfwpg80n.dll	W3NSL105.DLL
lfica80n.dll	lfwpg80w.dll	W3NSR103.DLL
lfica80w.dll	LTANN80N.DLL	W3SCMV7.DLL
lfimg80n.dll	LTANN80W.DLL	W3UPI104.DLL
lfimg80w.dll	LTEFX80N.DLL	WBEXEC.EXE
lfkodak.dll	LTEFX80W.DLL	WBTRCALL.DLL
lflma80n.dll	LTFIL80N.DLL	WBTRV32.DLL
lflma80w.dll	LTFIL80W.DLL	wcalc32.dll
lflmb80n.dll	LTIMG80N.DLL	zlib32.dll
lflmb80w.dll	LTIMG80W.DLL	

C:\windows\system32 - Annotation Editor support files. - AccuSoft OCX files.		
igmed32s.dll	imgthumb.ocx	oissq400.dll
IGMed32x.ocx	jpeg1x32.dll	oitwa400.dll
imgadmin.ocx	jpeg2x32.dll	oiui400.dll
imgcmn.dll	oieng400.dll	tifflt.dll
imgedit.ocx	oiprt400.dll	xiffr3_0.dll
imgscan.ocx	oislb400.dll	
imgshl.dll		

6.3.2 Background Processor Files

File Name	Description
GEAR32PO.OCX	Used by mag_makeabs.exe to create derivative files.
igmed32s.dll	Used by mag_makeabs.exe to create derivative files.
IGMed32x.ocx	Used by mag_makeabs.exe to create derivative files.
MagImportXControl1.ocx	Import API Active X control file used by the Background Processor.

File Name	Description
mag_makeabs.exe	Creates derivative files
Magbtm.exe	Processes queues and configures imaging system files.
MagHTMLARhive.exe	Creates HTML output log files
MagVerifier.exe	Performs database integrity checks.
MagPurge.exe	Removes old image files and recovers image files on VistA Imaging shares.

6.3.3 Online Help Files

Online help files are installed with the Clinical workstation, Background Processor, and VistARad software.

All three of the BP applications are documented in MAG_BPUserman.htm and the contents of the MAG_BPUserman_files subdirectory. The MAG_BP_User_Manual.PDF can also be found in the application subdirectory and can be accessed from the Help menu of the BP Queue Processor main window.

The clinical workstation help system is located in the Program Files\VistA\Imaging\Help\Client\index.htm subdirectory. A separate help file for TeleReader is located in Program Files\VistA\Imaging\Help\TeleReader.

The TeleReader Configurator Help file is in a separate folder from the Client Help file. Its contents are located in Program Files\VistA\Imaging. The file name is AGTeleReaderConfig.pdf.

6.3.4 DICOM Gateway Files

The following tables list files that are part of a DICOM Gateway installation. Files are grouped by folder.



C:\Program Files\VistA\Imaging\DICOM – Primary program files	
File Name	Description
BATCH_SEND_IMAGE.BAT	Batch file that takes a folder of DICOM objects and sends them to a storage provider.
DICOM_ECHO.EXE	Program that can be used to test network connectivity with DICOM modalities.

C:\Program Files\Vista\Imaging\DICOM – Primary program files	
File Name	Description
DRIVES.EXE	Program that provides information on currently mounted disk drives.
ERRLOOK.EXE	Program that can be used to display the meaning of an MS-Windows error code.
MAG_COMPRESSOR_AWARE.EXE	Program to compress image files before transmission.
MAG_CSTORE.EXE	Program that runs on the DICOM Gateway to store images.
MAG_DCMABSTRACT.EXE	Program that creates abstracts (thumbnails of images) from DICOM objects.
MAG_DCMTOTGA.EXE	Program that converts DICOM images to Targa Images.
MAG_DCM_COPY.EXE	Program that copies parts of DICOM files (used for modifying information in image headers).
MAG_MAKELINK.EXE	Program to create icons.
MAG_RECON.EXE	Program to reconstruct a DICOM File from an existing DICOM file and a script file containing header-information.
MAG_RECON.TXT	Sample script file to be used with MAG_Recon.exe.
MAG_TELNET.CNT	Table of contents for Help file.
MAG_TELNET.EXE	Help file for Telnet client application.
MAG_TELNET.HLP	Telnet client application.
MAG_TGATODCM.EXE	Program that converts Targa images to DICOM images.
MAG_VISTA_SEND_IMAGE.EXE	Program that transmits image files.

C:\Program Files\VistA\Imaging\DICOM – Primary program files	
File Name	Description
MSVCR71.DLL	Support library for executables compiled with Microsoft C Compiler.
OD.EXE	Program that produces octal dumps of binary files.
PATHMAN.EXE	Program that manipulates the default “path” lookup string.
SEND_IMAGE.EXE	Program that transmits image files.
SLEEP.EXE	Program that allows a batch file to “wait” for a couple of seconds.

C:\Program Files\VistA\Imaging\DCMView – DICOM Viewer program files	
File Name	Description
MAG_DCMVIEW.EXE	Program to display DICOM images.
VIEWER1.ICO	Icon for MAG_DCMView.exe program.

C:\Program Files\VistA\Imaging\MAG_MakeAbs – Abstract generator files	
File Name	Description
MAG_DCMABSTRACT.ICO	Icon for MAG_DCMabstract.exe.
README.TXT	File, which provides status information about the Abstract Maker installation,

C:\DICOM – Icon files	
File Name	Sample
MAGCSTORE.ICO	
MAGVISTA.ICO	

C:\DICOM\Abstract – Files used for generic abstracts for certain image types	
File Name	Description
MAG_CANNED_ECG.BMP	Canned abstract for PDF files
MAG_CANNED_PDF.BMP	Canned abstract for ECG files
MAG_WHATEVER.BMP	Canned abstract for other types of files that cannot have abstracts generated “on the fly”

C:\DICOM\Cache – Cache database folder	
File Name	Description
CACHE.DAT	Program that has the Cache database for DICOM Gateways.
CSTORE.OUT	Startup log file produced by backend MUMPS server for the MAG_CSTORE.EXE front end storage provider processes.
WORKLIST_60010.OUT	Startup log file produced by backend MUMPS server for the Modality Worklist provider processes.

C:\DICOM\Data1 – Text data folder; additional Data2, Data3, folders may exist <i>May be stored in other local drives on older systems</i>	
File Name	Description
INIT_DICOM.BAT	Program that re-initializes the subdirectories of the directory in which the BAT file is stored.
SEARCH.BAT	Program that scans .TXT files for the occurrence of a specified string.

C:\DICOM\Icons (Letters) – Icon collection	
Sample	Description
	Contains various .ico files that can be assigned to desktop shortcuts to make modality-specific functions easier to tell apart. For detailed information, see Appendix A in the DICOM Gateway Installation Guide

C:\DICOM\Icons (VA Logo) – Icon collection	
Sample	Description
	Contains various .ico files that can be assigned to desktop shortcuts to make modality-specific functions easier to tell apart. For detailed information, see Appendix A in the DICOM Gateway Installation Guide

<drive>:\DICOM\Dict – Dictionary files, typically stored in a network folder	
File Name	Description
AE_TITLE.DIC	Dictionary file that maps DICOM Application Entity Titles to well-known aliases and provides descriptions.
CT_PARAM.DIC	Table containing prior settings for conversion parameters. Imported by ^MAGDMFB7.
DATA_CR.DIC	Additional data fields to be displayed on DICOM Gateway. Imported by ^MAGDIR4.

<drive>:\DICOM\Dict – Dictionary files, typically stored in a network folder	
File Name	Description
DATA_MRI.DIC	Additional data fields to be displayed on DICOM Gateway. Imported by ^MAGDIR4.
DATAGECT.DIC	Additional data fields to be displayed on DICOM Gateway (General Electric). Imported by ^MAGDIR4.
DATAMISC.DIC	Additional data fields to be displayed on DICOM Gateway. Imported by ^MAGDIR4.
ELEMENT.DIC	DICOM Element dictionary. Imported by ^MAGDMFB2.
HL7.DIC	VistA HL7 dictionary. Imported by ^MAGDMFB7.
INSTRUMENT.DIC	List of image producing instruments, distributed as Instrument.Sample. Imported by ^MAGDMFB8
INSTRUMENT.SAMPLE	Distributed initial version of INSTRUMENT.DIC.
MODALITY.DIC	Image processing rules for modalities. Imported by ^MAGDMFB8.
MODALITY.SAMPLE	Distributed initial version of MODALITY.DIC.
PORTLIST.DIC	Locally edited list of network ports for DICOM services. Imported by ^MAGDMFB9.
PORTLIST.SAMPLE	Distributed initial version of PORTLIST.DIC.
ROUTE.DIC	Locally edited list of image processing rules for automatic routing. Imported by ^MAGBTRB1.
ROUTE.SAMPLE	Distributed initial version of ROUTE.DIC.
SCP_LIST.DIC	Provider application parameters. Imported by ^MAGDMFB9.
SCU_LIST.DIC	List of Service Class User Applications, distributed as SCU_List.Sample. Imported by ^MAGDMFB9.
TEMPLATE.DIC	Macros for event message templates. Imported by ^MAGDMFB3.

<drive>:\DICOM\Dict – Dictionary files, typically stored in a network folder	
File Name	Description
TEMPLATE.TMP	Temporary file created when loading the TEMPLATE.dic dictionary.
UID.DIC	UID dictionary. Imported by ^MAGDMFB4.
WORKLIST.DIC	Locally edited list of the modality Called Application Entity Titles and the corresponding DICOM Modality Worklist database attributes. Imported by ^MAGDMFB8.
WORKLIST.SAMPLE	Distributed initial version of WORKLIST.DIC.

C:\DICOM\Web – Contains temporary files that are used in the installation process.	
File Name	Description
MAGDICOM.SETUP.CSP	Temporary file used in the installation process.
MAGDICOM.STATUS.CSP	Temporary file used in the installation process.
MAGLOGO1.GIF	Temporary file used in the installation process.
MAGLOGO2.GIF	Temporary file used in the installation process.
MAGMASTERFILE.CSP	Temporary file used in the installation process.
VABKG.JPG	Temporary file used in the installation process.

6.3.4.1 Sample Files

For the purpose of testing that the software is properly installed, a number of sample files are included in the distribution kit.

6.3.4.1.1 Sample DICOM Images

The sample images that are available for the DICOM gateway can be used to perform trial image transmissions.

File	Description
BabyFace.dcm	Ultrasound image (640x480 pixels)

File	Description
BoneScrw.dcm	CR image (2048x2577 pixels)
Carotid.dcm	Ultrasound image (640x480 pixels)
EyeCLens.dcm	(640x560 pixels)
EyeClot.dcm	(640x560 pixels)
EyeLens.dcm	(640x560 pixels)
EyeSttch.dcm	(640x560 pixels)
Fillings.dcm	IO image (811x644 pixels)
GoldGate.dcm	Picture of the Golden Gate Bridge in San Francisco, labeled as modality type OT (other) (640x480 pixels).
Implant.dcm	IO image (811x644 pixels)
PaceMkr.dcm	CR image (1716x1910 pixels)
Retina.dcm	(640x480 pixels)
Roots.dcm	IO image (811x644 pixels)
Skull.dcm	CR mage (2048x2577 pixels)
Spine.dcm	CR image (2048x2495 pixels)
test.txt_new	Sample command file, used for modifying information in image headers.

6.3.4.1.2 Sample HL7 Data Streams

The following sample HL7 streams are available.

File	Description
Baltimore.gbl	Small data set
Boston.gbl	Large data set

6.3.5 VistARad Workstation Files

Files that are installed on a VistARad workstation are listed below. Files are grouped by folder.

Folder **C:\Documents and Settings\\Desktop**

- **MAG_VistARad_Patch115** – desktop shortcut

Folder **C:\Documents and Settings\\Start Menu\Programs\VistA Imaging Programs**

- **MAG_VistARad_Patch115** – start menu shortcut

Folder **C:\Program Files\VistA\Imaging\MAG_VistARad**

- **MAG_Vistarad.exe** – VistARad main executable file
- **MAG_Vistarad_Util.exe** – VistARad teaching file support executable
- **DimFileX.ocx** – dynamic link library executable (DLL for short) for Dome ActiveX control
- **DimplX.ocx** – DLL for Dome ActiveX control
- **DXShared.dll** – DLL for Dome ActiveX control
- **RPCBrokerCom.dll** – DLL for Broker ActiveX control
- **Bapi32_47.dll** – DLL for Broker ActiveX control
- **VIXBroker.dll** -- DLL for VistA Imaging Exchange broker
- **VA_DelphiUtils.dll** – DLL for password decryption to gain access to image share
- **VA_DICOM.dll** – DLL for accessing DICOM files
- **LayoutSelect.dll** – VistARad core functionality DLL (core DLL)
- **RpcDbAccessCom.dll** – core DLL
- **SliceCalc.dll** – core DLL
- **TargaFile.dll** – core DLL
- **VA_CaseManager.dll** – core DLL
- **VA_DxShared.dll** – core DLL
- **VA_GridCtrl.dll** – core DLL
- **VA_HPModule.dll** – core DLL
- **VA_ImgLdrCtrl.dll** – core DLL
- **VA_Manager.dll** – core DLL
- **VA_Shared.dll** – core DLL
- **VA_StackViewCtrl.dll** – core DLL
- **VA_TeachingFiles.dll** – core DLL
- **VA_Vistarad.dll** – core DLL
- **MAGJ.INI** – VistARad settings
- **template.dcm** – internally used to create DICOM files
- **MAG_Dicom_Attributes.lst** – used for internal reference
- **MAG_Special_Attributes.lst** – used for internal reference
- **Mag_DicomTags.txt** – used for internal reference
- **Mag_statusdatasettings.txt** – used for internal reference
- **modality.txt** – used for internal reference

- **HPConfig.xml** –used for internal reference
- **radlertree.xml** –internally used for Teaching Files feature
- **MAG_VistARad_User_Guide.pdf** – VistARad help
- **MAG_vrad_QSG.pdf** – VistARad help
- **MAG_Vrad_Quick_Ref.pdf** – VistARad help
- **MAG_vrad_Shortcuts.pdf** – VistARad help

Folder **C:\WINDOWS\system32**

- **dimpl8.dll** – DLL for Dome ActiveX control

Redistributable packages for necessary runtimes (typically installed in **C:\WINDOWS\system32** and/or **C:\WINDOWS\WinSxS**)

- **Microsoft OLE 2.40 for Windows NT(TM) and Windows 95(TM) Operating Systems**
- **Visual C++ 8.0 ATL (x86) WinSXS MSM**
- **Visual C++ 8.0 CRT (x86) WinSXS MSM**
- **VC User gdiPlus RTL X86**

6.3.6 MAG_Decompressor Files

The following files are installed only on systems that are recipients of routed files that use compression. For more information, refer to the *Routing User Guide*.

Mag_Decompressor files are installed in: **C:\Program Files\Vista\Imaging\MAG_Decompressor**
 awj2k.dll (not distributed by Vista Imaging; purchased from Aware Inc.)
 MAG_Decompressor.exe (distributed by Imaging)

6.3.7 Storage Site Utilities

The following are maintenance utilities:

- MagUtility used for various maintenance tasks related to the RAID, database, and jukebox
- MagDexter used to provide jukebox platter reports for use with the new MagKat utility
- MagKat, a database maintenance tool used to backfill specific fields in the IMAGE file (#2005).

For details, see the *Storage Utilities User Manual*.

6.3.8 VIX Files

For a list of the files installed for the VIX (Vista Imaging Exchange) service, see the VIX Reference chapter in the *VIX Administrator's Guide*.

Chapter 7 VistA Imaging System M Files

The Food and Drug Administration classifies this software as a medical device. As such, it may not be changed in any way. Modifications to this software may result in an adulterated medical device under 21CFR820, the use of which is considered to be a violation of US Federal Statutes.

VA Policy states the following:

Those components of a national package (routines, data dictionaries, options, protocols, GUI components, etc.) that implement a controlled procedure, contain a controlled or strictly defined interface or report data to a database external to the local facility, must not be altered except by the Office of Information (OI) Technical Services (TS) staff. A controlled procedure is one that implements requirements that are mandated or governed by law or VA (Department of Veterans Affairs) directive or is subject to governing financial management standards of the Federal Government and VA or that is regulated by oversight groups such as the JCAHO or FDA. A controlled or strictly defined interface is one that adheres to a specific industry standard, will adversely affect a package and/or render the package inoperable if modified or deleted. For national software that is subject to FDA oversight, only the holder of the premarketing clearance (510(k)) is allowed to modify code for the medical device. The holder of a premarketing clearance is restricted to specifically designated TS staff that are located at the registered manufacturing site and operating in the designated production environment.

All routines files and fields of the VistA Imaging package may not be altered except by the OI Technical Services (TS) staff. This software is regulated by the FDA and implements controlled procedures. The only exception is data changes made in accord with Chapter 8 of this manual.

7.1 Introduction

The VistA Imaging System is based on the use of VA FileMan as an object-oriented database management system to store single or sequential images, and other multimedia object types.

This chapter first itemizes the various files that are used by the Imaging System (Clinical Capture/Display, Background Processor, and VistARad) and then describes how to obtain more detailed information about the files. Some of the files are used on the DICOM Image and Text Gateways and will reside on those systems and not on the VistA hospital system.

7.2 VA FileMan Files that are Part of the VistA Imaging System

7.2.1 VA FileMan Files

File	Name	Stored in
2005	IMAGE	^MAG(2005,D0,...
2005.01	-->EXPORT LOCATION	-->5,D1,...
2005.0106	-->ROUTING TIMESTAMP	-->4,D1,...
2005.011	-->LONG DESCRIPTION	-->3,D1,...
2005.0111	-->ROUTING LOG	-->6,D1,...
2005.04	-->OBJECT GROUP	-->1,D1,...
2005.210	--> PRESENTATION STATE	-->210,D1,...
2005.001	IMAGING STUDY	^MAG(2005.001,D0,...
2005.02	OBJECT TYPE	^MAG(2005.02,D0,...
2005.21	-->ACTIONS	-->1,D1,...
2005.24	-->CHILD CLASS	-->3,D1,...
2005.021	IMAGE FILE TYPES	^MAG(2005.021,D0,...
2005.03	PARENT DATA FILE	^MAG(2005.03,D0,...
2005.1	IMAGE AUDIT	^MAG(2005.1,D0,...
2005.11	-->EXPORT LOCATION	-->5,D1,...
2005.1106	-->ROUTING TIMESTAMP	-->4,D1,...
2005.111	-->LONG DESCRIPTION	-->3,D1,...
2005.1111	--> ROUTING LOG	-->6,D1,...
2005.14	-->OBJECT GROUP	-->1,D1,...
2005.2	NETWORK LOCATION	^MAG(2005.2,D0,...
2005.201	-->EMAIL	-->5,D1,...
2005.4	IMAGE HISTOLOGICAL STAIN	^MAG(2005.4,D0,...
2005.41	MICROSCOPIC OBJECTIVE	^MAG(2005.41,D0,...
2005.71	IMAGING DICOM FIELDS	^MAG(2005.71,D0,...
2005.712	MODULE	-->"M",D1,
2005.713	ELEMENT TAG	--> "E",D2,
2005.81	MAG DESCRIPTIVE CATEGORIES	^MAG(2005.81,D0,...
2005.82	IMAGE INDEX FOR CLASS	^MAG(2005.82,D0,...
2005.83	IMAGE INDEX FOR TYPES	^MAG(2005.83,D0,...

File	Name	Stored in
2005.84	IMAGE INDEX FOR SPECIALTY/SUBSPECIALTY	^MAG(2005.84,D0,...
2005.85	IMAGE INDEX FOR PROCEDURE/EVENT	^MAG(2005.85,D0,...
2005.852	--> SPECIALTY	--> 1,D1,...
2005.86	IMAGE ACTIONS	^MAG(2005.86.D0,...
2005.865	-->TYPE	-->2,D1,...
2005.87	IMAGE LIST FILTERS	^MAG(2005.87,D0,...
2005.88	MAG REASON FILE	^MAG(2005.88
2005.99	IMAGE INDEX FOR BODY PART	^MAG(2005.99,D0,...
2006.03	IMAGE BACKGROUND QUEUE	^MAGQUEUE(2006.03,D0,...
2006.031	IMAGE BACKGROUND QUEUE POINTER	^MAGQUEUE(2006.031,D0,...
2006.033	OFFLINE IMAGES	^MAGQUEUE(2006.033,D0,...
2006.034	IMPORT QUEUE	^MAG(2006.034,D0,...
2006.0341	-->IMAGE DATA	-->1,D1,...
2006.035	SEND QUEUE	^MAGQUEUE(2006.035,D0,...
2006.036	ROUTING STATISTICS	^MAGQUEUE(2006.036,D0,...
2006.03601	-->DETAILS	-->1,D1,...
2006.04	ACQUISITION DEVICE	^MAG(2006.04,D0,...
2006.041	ACQUISITION SESSION	^MAG(2007.041,D0,...
2006.1	IMAGING SITE PARAMETERS	^MAG(2006.1,D0,...
2006.11	-->MULTI NAMESPACE	-->4,D1,...
2006.112	-->FILE TYPES	-->2,D1,...
2006.12	--> ASSOCIATED INSTITUTIONS	--> INSTS,D1,...
2006.15	DICOM UID ROOT	^MAG(2006.15,D0,...
2006.166	--> BP MAIL MESSAGE	-->6,D1,...
2006.1662	-->--> Mail Group	-->1,D2,...
2006.1664	-->--> MESSAGE RECIPIENTS	-->3,D2,...
2006.1665	-->--> SECURITY KEYS	-->4,D2,...
2006.17	MUSE VERSIONS	^MAG(2006.17,D0,...
2006.18	IMAGING USER PREFERENCE	^MAG(2006.18,D0,...
2006.1867	-->PATIENT LIST	-->"PATLIST",D1,...

File	Name	Stored in
2006.19	IMAGING USERS	^MAG(2006.19,D0,...
2006.191	-->ADDITIONAL NAMESPACE	-->1,D1,...
2006.5	PACS MESSAGE	^MAGDHL7(2006.5,D0,...
2006.502	-->MESSAGE SEGMENTS	-->1,D1,...
2006.51	DICOM DATA ELEMENT DICTIONARY	^MAGDICOM(2006.51,D0,...
2006.514	-->ENUMERATED VALUE	-->1,D1,...
2006.511	DIAGNOSTIC INFO FIELD	^MAGDICOM(2006.511,D0,...
2006.5112	-->TAG	-->1,D1,...
2006.52	DICOM MESSAGE TEMPLATE DICTIONARY	^MAGDICOM(2006.52,D0,...
2006.5204	-->MESSAGE	-->1,D1,...
2006.53	DICOM UID DICTIONARY	^MAGDICOM(2006.53,D0,...
2006.5305	-->UID	-->1,D1,...
2006.531	EXTENDED SOP NEGOTIATION	^MAGDICOM(2006.531,D0,...
2006.532	DICOM SOP CLASS	^MAG(2006.532,D0,...
2006.539	DICOM UID SPECIFIC ACTION	^MAGDICOM(2006.539,D0,...
2006.5391	-->PURPOSE	-->1,...
2006.54	PDU TYPE	^MAGDICOM(2006.54,D0,...
2006.55	DICOM WORKLIST PATIENT	^MAGDWLST(2006.55,D0,...
2006.552	-->PATIENT	-->1,D1,...
2006.5522	-->-->MEDICAL ALERT	-->-->1,D2,...
2006.56	DICOM WORKLIST STUDY	^MAGDWLST(2006.56,D0,...
2006.562	-->STUDY	-->1,D1,...
2006.5621	-->-->PATIENT HISTORY	-->-->2,D2,...
2006.5622	-->-->APPOINTMENT SCHEDULE	-->-->1,D2,...
2006.563	DICOM GATEWAY PARAMETER	^MAGDICOM(2006.563,D0,...
2006.5631	-->DATA PATH	-->"DATA PATH",D1...
2006.5632	-->PROFILE	-->"PROFILE",D1...
2006.5634	-->INSTALLATION	-->"INSTALL",D1...
2006.564	DICOM QUEUE	^MAGDICOM(2006.564,D0,...
2006.5641	DICOM GATEWAY MACHINE ID	^MAGDICOM(2006.5641,D0,...
2006.565	EXPORT DICOM RUN FILE	^MAGDICOM(2006.565,D0,...

File	Name	Stored in
2006.57	DICOM HL7 SEGMENT	^MAGDICOM("HL7",D0,...
2006.5701	-->ELEMENT	-->1,D1,...
2006.571	DICOM RAW IMAGE	^MAGDICOM(2006.571,D0,..
2006.5711	DICOM M2MB RPC QUEUE	^MAGDINPT(2006.5711,D0,..
2006.5712	DICOM FIXED QUEUE	^MAGDINPT(2006.5712,D0,..
2006.5713	DICOM UNKNOWN MODALITY	^MAGDINPT(2006.5713,D0,..
2006.5714	DICOM INCOMPLETE OBJECT	^MAGDINPT(2006.5714,D0,...
2006.5715	CURRENT IMAGE	^MAGD(2006.5715,D0,...
2006.5719	DICOM ERROR LOG	^MAGDINPT(2006.5719,D0,..
2006.572	EXAMINATION COMPLETE	^MAGDINPT(2006.572,D0,..
2006.573	GE PACS QUERY/RETRIEVE	^MAGDGEQR(2006.573,D0,..
2006.5732	DICOM QUERY RETRIEVE RESULT	^MAGQR(2006.5732,D0,...
2006.57321	-->TAG	-->1,D1,...
2006.5733	QUERY/RETRIEVE STATISTICS	^MAG(2006.5733,D0,...
2006.57331	-->LOCATION	-->1,...
2006.574	DICOM IMAGE OUTPUT	^MAGDOUTP(2006.574,D0,..
2006.5744	-->IMAGE	--> -->1,D1,...
2006.575	DICOM FAILED IMAGES	^MAGD(2006.575,D0,...
2006.5751	DICOM OBJECTS TO BE IMPORTED	^MAGDICOM(2006.5751,D0,...
2006.5752	IMPORTABLE DICOM OBJECTS	^MAGD(2006.5752,D0,...
2006.57526	-->RELATED IMAGES	-->"RLATE",D1,...
2006.5757	DICOM RADIOLOGY PROCEDURE MODIFIERS	^MAGDICOM(2006.5757,D0,...
2006.5758	DICOM RADIOLOGY PROCEDURES	^MAGDICOM(2006.5758,D0,...
2006.5759	OUTSIDE IMAGING LOCATION	^MAGD(2006.5759,D0,...
2006.5761	DICOM MESSAGE STATISTICS	^MAGDAUDT(2006.5761,D0,...
2006.57611	-->MESSAGE	-->1,D1,...
2006.5762	DICOM INSTRUMENT STATISTICS	^MAGDAUDT(2006.5762,D0,...
2006.57621	-->LOCATION	-->1,D1,...

File	Name	Stored in
2006.5762111	-->-->INSTRUMENT	-->-->1,D2,... CONSNON>
2006.57621	-->INSTRUMENT	-->1,D1,...
2006.5763	DICOM PACS STATISTICS	^MAGDAUDT(2006.5763,D0,...
2006.57631	-->ACCESSION NUMBER	-->1,D1,...
2006.576311	-->-->EVENT	-->-->1,D2,...
2006.5764	DICOM LOCAL INSTRUMENT STATISTICS	^MAGDICOM(2006.5764,D0,...
2006.57641	-->DATE	-->1,D1,...
2006.577	DICOM FIFO QUEUE	^MAGDICOM(2006.577,D0,...
2006.5771	-->QUEUE LETTER	-->1,D1,...
2006.58	DICOM LOG	^MAGDMLOG(D0,...
2006.5801	-->TEXT	-->1,D1,...
2006.5802	-->LINE	-->2,D1,...
2006.581	INSTRUMENT DICTIONARY	^MAGDICOM(2006.581,D0,...
2006.582	MODALITY TYPE DICTIONARY	^MAGDICOM(2006.582,D0,...
2006.5821	CT CONVERSION PARAMETERS	^MAGDICOM(2006.5821,D0,...
2006.583	MODALITY WORKLIST DICTIONARY	^MAGDICOM(2006.583,D0,...
2006.5831	DICOM HEALTHCARE PROVIDER SERVICE	^MAGDICOM(2006.5831,D0,...
2006.5839	DICOM GMRC TEMP LIST	^MAGDICOM(2006.5839,D0,...
2006.584	TCP/IP PROVIDER PORT LIST	^MAGDICOM(2006.584,D0,...
2006.5841	TELEREADER ACQUISITION SERVICE	^MAG(2006.5841,D0,...
2006.5842	TELEREADER ACQUISITION SITE	^MAG(2006.5842,D0,...
2006.5843	TELEREADER READER	^MAG(2006.5843,D0,...
2006.5849	TELEREADER READ/UNREAD LIST	^MAG(2006.5849,D0,...
2006.585	USER APPLICATION	^MAGDICOM(2006.585,D0,...
2006.5852	-->SOP CLASS	-->1,D1,...
2006.58522	-->-->TRANSFER SYNTAX	-->-->1,D2,...
2006.586	PROVIDER APPLICATION	^MAGDICOM(2006.586,D0,...
2006.5863	-->SOP	-->1,D1,...

File	Name	Stored in
2006.58633	-->-->TRANSFER SYNTAX UID	-->-->1,D2,...
2006.587	DICOM TRANSMIT DESTINATION	^MAG(2006, 587,...
2006.588	APPLICATION ENTITY TITLE	^MAGDICOM(2006.588,D0,...
2006.59	ROUTING RULE	^MAGDICOM(2006.59,D0,...
2006.5901	-->RAW TEXT	-->1,D1,...
2006.5902	-->ACTION	-->ACTION,D1,...
2006.5903	--> -->PARAMETER	--> -->1,D2,...
2006.5904	-->CONDITION	--> -->1,D2,...
2006.5905	--> -->TIMEFRAME	--> -->1,D2,...
2006.5906	ROUTE LOAD BALANCE	^MAGRT(2006.5906,D0,...
2006.59061	-->PARENT	-->1,D1,...
2006.596	ACTION QUEUE STATUS	^MAGDICOM(2006.596,D0,...
2006.5961	-->THREAD	-->1,D1,...
2006.598	DICOM ERROR MESSAGE QUEUE	^MAGD(2006.598,D0,...
2006.599	DICOM Error Log	^MAGD(2006.599,D0,...
2006.621	MAG CT PARAMETER	^MAG(2006.621,D0,...
2006.623	MAG CR PARAMETER	^MAG(2006.623,D0,...
2006.63	MAG RAD LIST DATA ELEMENTS	^MAG(2006.63,D0,...
2006.631	MAG RAD LISTS DEFINITION	^MAG(2006.631,D0,...
2006.6311	-->COLUMNS	-->1,D1,...
2006.6312	-->SORT	-->2,D1,...
2006.634	MAGJ ZLIST SEARCH FILE	^MAG(2006.634,D0,...
2006.65	MAG RAD PRIOR EXAM LOGIC	^MAG(2006.65,D0,...
2006.66	-->PRIOR CASE MATCHING CPT GROUP	-->1,D1,...
2006.67	MAG RAD CPT MATCHING	^MAG(2006.67,D0,...
2006.674	-->BODY PART	-->1,...
2006.675	-->MODALITY	-->2,...
2006.68	MAGJ USER DATA	^MAG(2006.68,D0,...
2006.682	-->VR-WS	-->VR-WS,D1,...

File	Name	Stored in
2006.6821	-->-->DATA	-->-->VR-WS,D1,1,...
2006.6823	-->-->KEYS	-->-->VR-WS,D1,2,...
2006.683	-->VR-HP	-->VR-HP...
2006.6831	-->-->DATA	-->-->VR-HP,D1,1,...
2006.6832	-->-->KEYS	-->-->VR-HP,D1,2,...
2006.69	MAG VISTARAD SITE PARAMETERS FILE	^MAG(2006.69,D0,...
2006.8	BP WORKSTATIONS	^MAG(2006.8,D0,...
2006.81	IMAGING WINDOWS WORKSTATIONS	^MAG(2006.81,D0,...
2006.82	IMAGING WINDOWS SESSIONS	^MAG(2006.82,D0,...
2006.821	-->ACTIONS	-->"ACT",D1,...
2006.823	-->ERRORS	-->"ERR",D1,...
2006.83	DICOM WORKSTATION	^MAG(2006.83,D0,...
2006.87	DICOM GATEWAY INFORMATION	^MAG(2006.87,D0,...
2006.95	IMAGE ACCESS LOG	^MAG(2006.95,D0,...
2006.96	IMAGE INDEX CONVERSION	^MAGIXCVT (2006.96,D0...
2006.961	MULTI IMAGE PRINT FILE	^MAG(2006.961,
2006.9613	-->IMAGES PRINTED SUB- FILE	^MAG(2006.961,D0,"IMG",

7.2.2 More Detailed Information

More detailed information about these files can be obtained using the FileMan option LIST FILE ATTRIBUTES. The Data Dictionaries are considered part of the online documentation for this software application. It may be necessary to print the Data Dictionaries in order to support the package at your site.

The Data Dictionaries for VistA Imaging files may be printed using the VA FileManager's option LIST FILE ATTRIBUTES under the DATA DICTIONARY UTILITIES menu as follows:

```

VA FileMan 22.0

Select OPTION: DATA DICTIONARY UTILITIES
Select DATA DICTIONARY UTILITY OPTION: LIST FILE ATTRIBUTES
START WITH WHAT FILE: // IMAGE
      GO TO WHAT FILE: // IMAGE
      Select SUB-FILE: <RET>
Select LISTING FORMAT: STANDARD// BRIEF
ALPHABETICALLY BY LABEL? NO// YES
DEVICE:
    
```

The Data Dictionary will now print on the user's specified device.

7.3 Input Templates

The distribution contains the following input templates:

FILE #2005 MAG IMAGE INDEX EDIT
 FILE #2006.1: MAG PURGE PARAMETERS
 FILE #2006.1: MAG SITE PARAMETERS
 FILE #2006.1: MAG MUSE PARAMETERS
 FILE #2005.2: MAG ENTER/EDIT NETWORK LOC
 FILE #2005.2: MAG ENTER/EDIT MUSE NETWORK
 FILE #2005.575: MAGD-ENTRY
 FILE #2005.575: MAGD-UPDT
 FILE #2005.88: MAG REASON EDIT
 FILE #2006.8: MAG EDIT BACKGRND WORKSTA
 FILE #2006.631: MAGJ LIST EDIT
 FILE #2006.65: MAGJ PRIOR EDIT

7.3.1 Further Information

Every individual object (i.e., an image, audio clip, waveform, or scanned document) is an entry in the IMAGE file (#2005), where the object's attributes are managed. In addition, three auxiliary files are used:

- Object Type
- Network Location
- Parent Data

The objects are then related to the patient's VistA text data (medicine, surgery, laboratory, radiology reports or progress notes) through the use of pointers, both forward from the VistA PACKAGE file (#9.4) to the IMAGE file (#2005), and backwards from the IMAGE file (#2005) to the VistA PACKAGE file (#9.4). Software allows new objects to be added and displayed.

Several additional files are used by the system. These include:

- IMAGING WINDOWS WORKSTATIONS file (#2006.81), which contains information about every workstation on the network.
- IMAGE HISTOLOGICAL STAIN file (#2005.4), and the MICROSCOPIC OBJECTIVE file (#2005.41) used by anatomic pathology.
- IMAGING SITE PARAMETERS file (#2006.1).
- Background Queue files, which are necessary to manage abstract creation, automatic file migration (movement of image/object files between optical disk jukebox and magnetic disk), file copies.
- IMAGE ACCESS LOG file (#2006.95) used to track system utilization.

- User preferences files, which store personal preferences for the software configuration of the workstation.
- IMAGE LIST FILTERS file (#2005.87), which stores personal filters for each user, and public filters for all users
- IMAGE FILE TYPES file (#2005.021), which lists all image formats that VistA Imaging supports.
- Parameters that are specific for each individual DICOM Gateway Computer.
- Master files that drive the operation of the DICOM Gateway.
- Modality Worklist file that contains the scheduled activities for the various modalities that acquire images.
- Incoming Images.
- Images that need manual intervention before they can be entered into the VistA HIS.

7.4 File List

The VistA Imaging System files are in the 2005 through the 2006.999 numbering space. Full file and field documented attributes on any Imaging files can be obtained using the LIST FILE ATTRIBUTES sub-menu option located in the 'Data Dictionary Utilities menu.

```
VA FileMan 22.0
Select OPTION: DATA DICTIONARY UTILITIES
Select DATA DICTIONARY UTILITY OPTION: LIST FILE ATTRIBUTES
  START WITH WHAT FILE: DICOM FAILED IMAGES// 2005 IMAGE (7495 entries)
    GO TO WHAT FILE: IMAGE//
      Select SUB-FILE:
Select LISTING FORMAT: STANDARD//
DEVICE: UCX LOGIN Right Margin: 80//
```

7.5 File Security

VistA Imaging recommends no access to any Imaging files by any end-user other than IRM personnel. Please review the Security manual to get a detail listing of all FileMan protections on all Imaging files. All updating of Imaging files is done via the GUI interface or by the Imaging System Manager menu (locked by the MAG SYSTEM security key) on the VistA hospital system. However, the recommended method is to use the VistA Imaging Background Processor application (GUI).

Imaging Entity Relationship Diagram and Detailed Information

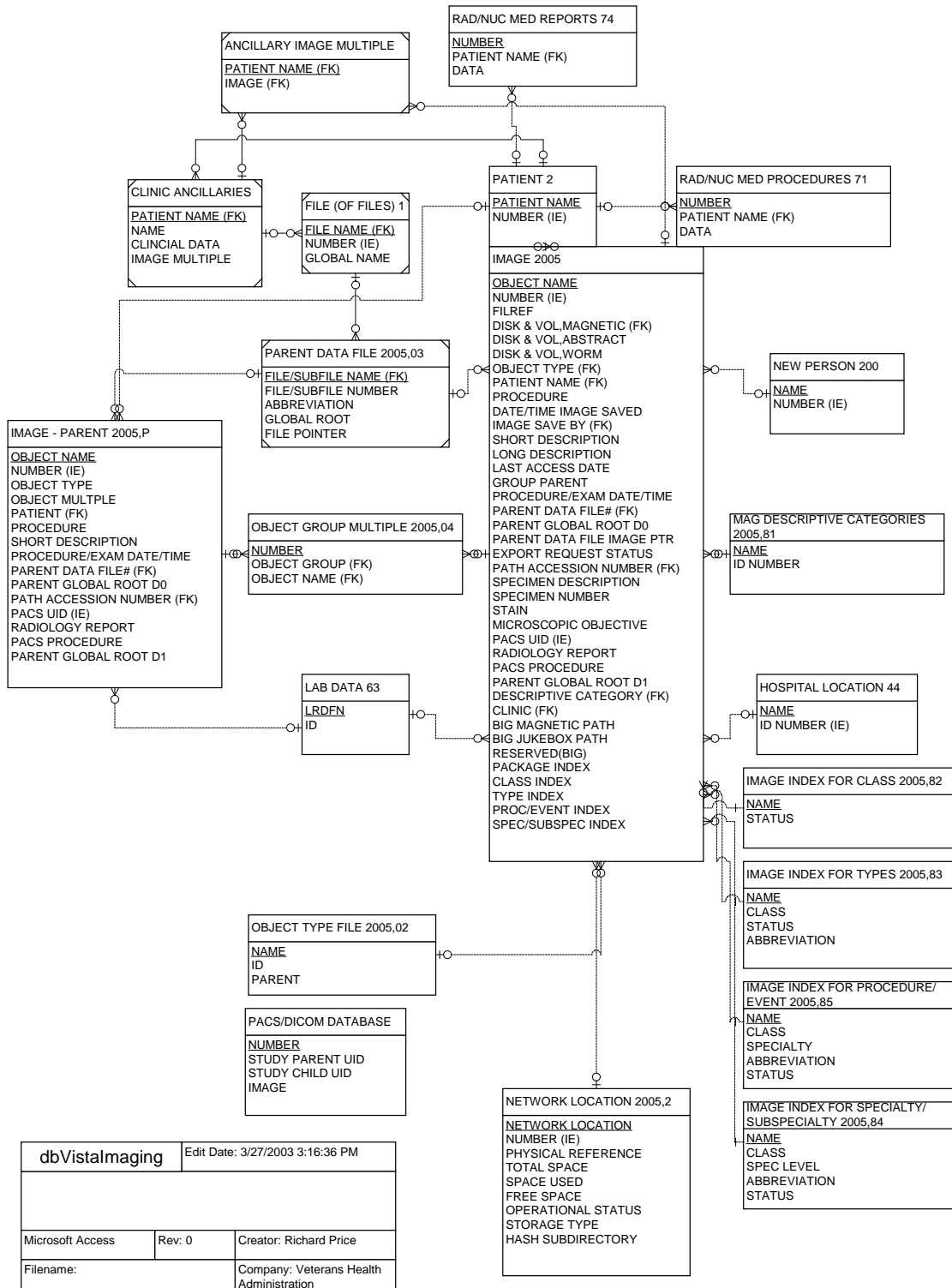

A detailed File Diagram can be obtained using the FileMan's menu option 'MAP POINTER RELATIONS'.

- Select 'DATA DICTIONARIES UTILITIES' from the FileMan menu.
- Select 'MAP POINTER RELATIONS' menu option.
- Respond to the 'PACKAGE NAME' prompt with IMAGING.

7.6 Global Journaling

Journaling of the VistA Imaging global is mandatory. MAG* should be journaled.

During a scheduled VistA (hospital) servers downtime, it is highly recommended to coordinate any data restore activities related to the VistA Imaging System with the IRM staff.

7.7 VistA System Outages

During a VistA System outage, DICOM Gateways will continue to provide modality worklist functionality and to capture images that are temporarily stored on the gateway. This is important to allow the radiology department to continue to perform studies. If you anticipate that the VistA System must be down, it is best to take the following steps:

- Perform all DICOM fixes before the VistA System goes down. This will free the maximum space for temporary image storage.
- During the outage, watch the gateways to be sure they still have adequate space to store images.

Chapter 8 Exported Options

8.1 Introduction: INI File Setup and Configuration of Workstations

INI files are DOS files with the extension .INI (such as WIN.INI and MOUSE.INI) that contain initialization information for programs. Initialization refers to the parameters that control the way a program is initially launched. They also customize the application to accommodate workstation-specific characteristics, such as the type of capture hardware installed (Refer to *Vista Imaging System Installation Guide* for further details). The INI files are set up initially when the software is first installed on the workstation.

Note: Entries for these files should be made via the MAGSYS.EXE routine located in directory Program Files\VISTA\IMAGING.

8.2 Imaging System Manager Menu

The Imaging System Manager menu contains system manager functions. Access to these menu options requires the Imaging System Menu IMAGSYS MENU security key and FileMan access of “@.”

Menu Diagram for Imaging System Menu [MAG SYS MENU]

```
HL7   Imaging HL7 Messaging Maintenance ...
IX    Image Index Conversion Menu ...
LS    Edit Network Location STATUS
TR    Telereader Menu ...
      Ad hoc Enterprise Site Report
      Delete Image Group
      Enter/edit Reason
      Imaging Database Integrity Checker Menu ...
      Imaging Site Reports ...
      Importer Menu ...
```

Editing the Network Location Status should be performed by using the Network Location Manager in the Background Processor.

Imaging Database Integrity checking (indicated by an arrow) should be performed in the Background Processor using the Verifier application.

Note: You can enter ?? at the Select Imaging System Manager Menu Option prompt for a description of each menu option.

See the *Background Processor User Manual* for more information.

For detailed information about the ‘Telereader Menu ...’ option, refer to the TeleReader Configuration document.

For detailed information about the “Ad hoc Enterprise Site Report” option and the “Imaging Site Reports” option, refer to Chapter 12.

8.2.1 IMAGING HL7 MESSAGING MAINTENANCE [MAG HL7 MAINT]

This option contains sub-options that allow you to modify parameters relating to the transmission of HL7 ADT messages to commercial PACS (cPACS) and to select the version of HL7 order messages that should be sent from VistA Radiology to cPACS and to the VistA Text Gateway.

Note: If you need help with the sub-options of this option, consult the designated HL7 specialist within the IRM department at your site.

Menu Diagram for Imaging HL7 Messaging Maintenance [MAG HL7 MAINT]

RHL7	Maintain Subscriptions to Radiology HL7 Drivers
IHE	Configure IHE-Based HL7 Interface to PACS

8.2.1.1 MAINTAIN SUBSCRIPTIONS TO RADIOLOGY HL7 DRIVERS [MAGD MAINT RAD HL7 SUBS]

This option allows you to select the version of HL7 order messages that should be sent from VistA Radiology to cPACS and to the VistA Text Gateway.

From the Imaging System Manager Menu, select HL7:

Select Imaging System Manager Menu Option: HL7	Imaging HL7 Messaging Maintenance
---	-----------------------------------

From the Imaging HL7 Messaging Maintenance Menu, select RHL7:

Select Imaging HL7 Messaging Maintenance Option: RHL7	Maintain Subscriptions to Radiology HL7 Drivers
--	---

VistA Imaging first verifies that all applicable HL7 protocols are available. There are two Imaging subscriber protocols and eight Radiology event driver protocols – four for HL7 Version 2.1 messages and four for HL7 Version 2.4 messages.

<pre> MAGD SEND ORM protocol found... MAGD SEND ORU protocol found... RA CANCEL protocol found... RA EXAMINED protocol found... RA REG protocol found... RA RPT protocol found... RA CANCEL 2.4 protocol found... RA EXAMINED 2.4 protocol found... RA REG 2.4 protocol found... RA RPT 2.4 protocol found... </pre>
--

VistA Imaging then asks which version of HL7 you wish to be used to generate Radiology messages. Enter 2.1 or 2.4.

Enter the desired version of HL7: 2.4	HL7 Version 2.4
--	-----------------

If the desired HL7 version is not currently in use, VistA Imaging adjusts protocol subscriptions to cause the desired version to come into use.

<pre> Subscribing to HL7 version 2.4 protocols... Protocol RA CANCEL has been unsubscribed from... Protocol RA EXAMINED has been unsubscribed from... Protocol RA REG has been unsubscribed from... Protocol RA RPT has been unsubscribed from... </pre>
--

```
Protocol RA CANCEL 2.4 has been subscribed to...
Protocol RA EXAMINED 2.4 has been subscribed to...
Protocol RA REG 2.4 has been subscribed to...
Protocol RA RPT 2.4 has been subscribed to...
```

If the desired HL7 version is already in use, the system will take no action.

```
Subscribing to HL7 version 2.4 protocols...
Protocol RA CANCEL is not currently subscribed to, no action taken...
Protocol RA EXAMINED is not currently subscribed to, no action taken...
Protocol RA REG is not currently subscribed to, no action taken...
Protocol RA RPT is not currently subscribed to, no action taken...
Protocol RA CANCEL 2.4 is already subscribed to, no action taken...
Protocol RA EXAMINED 2.4 is already subscribed to, no action taken...
Protocol RA REG 2.4 is already subscribed to, no action taken...
Protocol RA RPT 2.4 is already subscribed to, no action taken...
```

8.2.1.2 CONFIGURE IHE-BASED HL7 ADT INTERFACE TO PACS

This option allows you to modify parameters relating to the transmission of HL7 version 2.4 ADT messages to commercial PACS (if used) and the DICOM Text Gateway.

From the Imaging System Manager Menu, select HL7:

```
Select Imaging System Manager Menu Option: HL7 Imaging HL7 Messaging Maintenance
```

From the Imaging HL7 Messaging Maintenance Menu, select IHE:

```
Select Imaging HL7 Messaging Maintenance Option: IHE Configure IHE-Based HL7 Interface to PACS
```

VistA Imaging first asks you to verify the name of the sending application and the receiving application. These are the applications in the HL7 APPLICATION PARAMETER File (#771) whose NAME Field values are associated with the entries in field 3 and 5 respectively, and whose FACILITY NAME Field values are associated with the entries in fields 4 and 6 respectively, of the Message Header (MSH) segments of the outbound HL7 messages

Note: This option only changes the names of the sending and receiving applications. To change the names of the sending and receiving facilities, get help from the designated HL7 specialist within the IRM department at your site.

```
Sending application name:   MAG VISTA IMGNG
Receiving application name: MAG COMRCL PACS

Do you wish to change either of these names?
```

If you wish to accept the application names that are presented, enter **N**. Otherwise, enter **Y** and enter the desired new application names at the prompts:

```
Please enter the name of the SENDING application.
NAME: MAG VISTA IMGNG// < enter the new sending application name here
Please enter the name of the RECEIVING application.
NAME: MAG COMRCL PACS// < enter the new receiving application name here
```

VistA Imaging next asks you to enter the TCP/IP address and port number of the logical link over which the outbound VistA HL7 stream will be transmitted to cPACS.

```
Please enter the TCP/IP address and port number for the logical link.
TCP/IP ADDRESS: ← enter the TCP/IP address here
TCP/IP PORT: ← enter the port number here
```

Finally, you are asked whether you wish to turn on the IHE-based PACS interface, which will transmit IHE-conformant ADT HL7 messages from VistA HIS to cPACS (if used) and to the DICOM Text Gateway.

```
Enter Y or YES below to turn the IHE-based HL7 PACS interface ON;
enter N or NO to turn the interface OFF.

IHE PACS HL7 INTERFACE ACTIVE:
```

Enter **Y** to turn the interface on or **N** to turn it off.

8.3 MAG REASON EDIT [MAG SYS MENU]

This menu option allows adding/editing of reasons for actions performed on images (copying, printing, etc.) stored in the MAG REASON file (#2005.88). The Reason codes and definitions shown are samples only.

```
IX      Image Index Conversion Menu ...
LS      Edit Network Location STATUS
TR      Telereader Menu ...
        Ad hoc Enterprise Site Report
        Delete Image Group
        Enter/edit Reason
        Imaging Database Integrity Checker Menu ...
        Imaging Site Reports ...
```

From the MAG REASON EDIT [MAG SYS MENU] select the “Enter/edit Reason” menu option.

```
Select Imaging System Manager Menu Option: Enter/edit Reason
```

At the prompt "Select MAG REASON:" enter a reason number to display an existing reason; or a ? to display a list of all MAG REASON numbers currently stored.

```
Select MAG REASON: ?
Answer with MAG REASON, or NUMBER, or CODE
Do you want the entire 13-Entry MAG REASON List? yes (Yes)
  Choose from:
  1          Clinical care for the patient whose images are being downloaded
1 -Copy-Print-
  2          Clinical care for other VA patients  2 -Copy-Print-
  3          For use in approved research by VA staff  3 -Copy-Print-
  4          For approved teaching purposes by VA staff  4 -Copy-Print-
  5          For use in approved VA publications  5 -Copy-Print-
  6          Authorized release of medical records or health information (ROI
) 6 -Copy-Print-
  7          Corrupt image  7 -Delete-
  8          Low quality image  8 -Delete-Status-
  9          Wrong case/exam/accesion number  9 -Delete-Status-
 10         Wrong note title 10 -Delete-
 11         Wrong patient 11 -Delete-
 12         Image is incorrectly included in an image group 12 -Status-
 13         All images were removed from the group 13 -Delete-

You may enter a new MAG REASON, if you wish
Answer must be 3-70 characters in length.
```

A new MAG REASON is added by entering the name of a new MAG REASON at the prompt.

```
Select MAG REASON: Reference
Are you adding 'Reference' as a new MAG REASON (the 14TH)? No// yes (Yes)
MAG REASON CODE: L14// To refer to the patient image as reference material.
?
Enter unique code of the reason (from 1 to 999999). Codes of local reasons
must be preceded by letter L.
MAG REASON CODE: L14// L14
REASON: Reference//
```

8.4 MAG CLIENT VERSION REPORT

MAG CLIENT VERSION REPORT [MAG REPORT MENU] This option prints the list of workstations and clients that are in need of updates. When the new version of the VistA server code is distributed, those clients may continue, but they are not supported.

```
IX      Image Index Conversion Menu ...
LS      Edit Network Location STATUS
TR      Telereader Menu ...
        Ad hoc Enterprise Site Report
        Delete Image Group
        Enter/edit Reason
        Imaging Database Integrity Checker Menu ...
        Imaging Site Reports ...

Select Imaging System Manager Menu Option: Imaging Site Reports ... ??
```

From the Imaging System Menu [MAG SYS MENU], the user will enter "Imaging Site Reports" at the prompt.

```
IX      Image Index Conversion Menu ...
LS      Edit Network Location STATUS
TR      Telereader Menu ...
        Ad hoc Enterprise Site Report
        Delete Image Group
        Enter/edit Reason
        Imaging Database Integrity Checker Menu ...
        Imaging Site Reports ...

Select Imaging System Manager Menu Option: Imaging Site Reports
```

At the prompt, the user will enter "Imaging Site Report".

```
Document Count
Image Type Count by User
Imaging Clients Version Report
MEANS TEST
Package Index Contains 'Note'

Select Imaging Site Reports Option: Imaging Clients Version Reportort

Select one of the following:

V      Site-Client-Version-Workstation Name
W      Site-Workstation Name-Client

Report Sort Mode: v Site-Client-Version-Workstation Name
DEVICE: HOME// w WORK PRINTER ROOM
Do you want your output QUEUED? No// no (No)
```

At the prompt, the user will enter "V" and a report similar to the sample report below will be displayed.

LIST OF WORKSTATIONS AND CLIENTS THAT HAVE TO BE UPDATED					
=====					
SALT LAKE CITY					
					Page 2
Client	Client Version	Workstation Name	Client Date	Last Logon	Type
-----	-----	-----	-----	-----	-----
CAPTURE	2.5.0.7	ISW-XXX1	03/09/99	04/27/99	
CAPTURE	2.5.0.9	ISW-XXX2	06/21/99	07/09/99	
CAPTURE	2.5.0.10	ISW-XXX4	11/17/99	11/24/99	
Enter RETURN to continue or '^' to exit:					
					Page 3

8.5 Imaging VistARad System Options

The VistARad System Options Menu is used to set site parameters that control VistARad’s basic behaviors and performance, to create custom exam lists, and to review and manage VistARad’s prefetch and CPT (Current Procedural Terminology) code matching capabilities.

Menu Diagram for MAGJ MAIN

Select OPTION NAME: MAGJ MAIN	VistARad System Options
SITP	E/E VistaRad Site Parameters
ELIS	E/E VistaRad Exam Lists
PLIS	Print VistaRad List Definition
EPRF	E/E VistaRad Prefetch Logic
I PRF	Inquire Prefetch Logic
PPRF	Print VistaRad Prefetch Logic Table
ECPT	E/E VistaRad CPT Matching Set
ICPT	Inquire VistaRad CPT Matching Set
PCPT	Print VistaRad CPT Matching Logic Table

8.6 Imaging MAG WINDOWS Menu Option

The menu option MAG WINDOWS should be assigned as a secondary menu option to end-users who need access to VistA Imaging, and to all users and operators of the DICOM Gateways and Background Processor applications. This menu outlines enables:

- Access to all the RPCs used by VistA Imaging
- An automated log-on to applications experiencing service interrupted by network and host system outages

8.7 Imaging VistaRad MAGJ VISTARAD WINDOWS

The menu option MAGJ VISTARAD WINDOWS should be assigned as a secondary menu option to end-users who need access to VistA Imaging VistARad. This menu outlines all the RPCs used by VistARad.

8.8 Imaging MAG JB OFFLINE Menu option

This menu option is not part of any menu and is discussed in chapter 9 of this manual; section Removing Jukebox Media - Offline Images.

8.9 Imaging DICOM Menu

The VistA Imaging DICOM Gateway itself does not use VA Kernel software, and as a result, does not use any Options. However, on the VistA hospital system the following menu does relate to the DICOM Gateways. See the *Imaging DICOM User Manual* for full instructions on using this menu.

Menu Diagram for MAGD DICOM MENU

```
Select Dicom Menu Options Option: [MAGD DICOM MENU]

ECTP Edit CT PARAMETER File [MAGD CT PARAMETER EDIT]
ICTP Display MAGD CT PARAMETER entries [MAGD CT PARAMETER INQUIRY]
ECRP Edit CR PARAMETER File [MAGD CR PARAMETER EDIT]
ICRP Display MAGD CR PARAMETER entries [MAGD CR PARAMETER INQUIRY]
Correct Clinical Specialities DICOM File Entries [MAGD FIX CLINSPEC DICOM FILE]
Correct RAD-DICOM File Entries [MAGD FIX DICOM FILE]
Clean Up DICOM Gateway (DICOM Destinations) [MAGD REMOVE GATEWAY XMIT]
Clean Up DICOM Gateway (Failed Images) [MAGD REMOVE GATEWAY FAILED]
List Unread Studies [MAGD LIST UNREAD STUDIES]
Print Dicom Failed Image File Entries [MAGD PRINT DICOM FILE]
Rename DICOM Gateway (DICOM Destinations) [MAGD RENAME GATEWAY XMIT]
Rename DICOM Gateway (Failed Images) [MAGD RENAME GATEWAY FAILED]
Validate DICOM Correct Information [MAG DICOM CORRECT VALIDATE]

Select Dicom Menu Options Option:
```

8.9.1 MAG IMPORT DICOM OBJECTS Menu Option

On the DICOM Gateway there is the new menu option 2-12 Import DICOM Studies:

```
VistA DICOM Image Gateway -

 1 (Receive PACS Exam Complete Messages)
 2 (Send PACS Request Image Transfer Messages)
 3 Process DICOM Images
 4 Increment DICOM Image Input Pointer
 5 Display Real-Time Storage Server Statistics
 6 Display Cumulative Storage Server Statistics
 7 Display Daily Image Processing Statistics
 8 Send DICOM Images to Another Storage Server
 9 Display a DICOM Image Header
10 Re-Transmit Images from PACS
11 Purge Incomplete Image Information
12 Import DICOM Objects
13 Validate Failed Image Table
```

The new Import DICOM Studies branches to 9 new menu options:

```

Import DICOM Studies -
1  Import DoD studies that were transmitted directly to the VA
2  Import Outside Contracted studies
3  CD/DVD Import Unordered studies from DoD facilities
4  CD/DVD Import Unordered studies from other VA facilities
5  CD/DVD Import Unordered studies from non-VA/DoD facilities
6  Correct local studies with bad PID and/or study information
7  Build Radiology Procedure File
8  Build Radiology Modifiers File
9  Modify Exam/Report Status Update Parameters
    
```

Menu option 9 Modify Exam/Report Status Update Parameters branches to 7 new menu options:

```

Modify Exam/Report Status Update Parameters -
1  Display Exam/Report Status Update Parameters
2  Modify Radiology Technologist
3  Modify Film Entry
4  Modify Diagnostic Code
5  Modify Camera/Equipment Room
6  Modify CPT Modifier
7  Modify All the above Parameters
    
```

A new menu option UPDATE AE TITLE has been installed as menu option 3. The existing menu options (old numbers 3 through 11) have been renumbered to allow this new option.

```

Gateway Configuration and DICOM Master Files -
1  Display Gateway Configuration Parameters
2  Update Gateway Configuration Parameters
3  Update AETITLE.DIC
4  Update INSTRUMENT.DIC
5  Update MODALITY.DIC
6  Update PORTLIST.DIC
7  Update SCU_LIST.DIC
8  Update WORKLIST.DIC
9  Reinitialize All the DICOM Master Files
10 Create Shortcuts for Instruments
11 Validate Access/Verify Codes for Modality Worklist
12 Display Versions and/or Time Stamps of Components
    
```

8.10 Imaging Menu Options Documentation

A full description for all of the Imaging’s VistA menu options can be obtained by using FileMan print menu option.

```

Select OPTION: print FILE ENTRIES

OUTPUT FROM WHAT FILE: OPTION//
SORT BY: NAME//
START WITH NAME: FIRST// MAG
GO TO NAME: LAST// MAGZ
  WITHIN NAME, SORT BY:
FIRST PRINT FIELD: [CAPTIONED

Include COMPUTED fields: (N/Y/R/B): NO// - No record number (IEN), no Computed
Fields
DISPLAY AUDIT TRAIL? No// NO
Heading (S/C): OPTION LIST//
START AT PAGE: 1//
DEVICE:
    
```

8.10.1 MAG DICOM IMPORTER Menu Option

```

Select Imaging System Manager Menu Option: ??

IX      Image Index Conversion Menu ... [MAG IMAGE INDEX MENU]
LS      Edit Network Location STATUS [MAG SYS-EDIT NET LOC STATUS]
TR      Telereader Menu ... [MAGT TELEREADER MENU]
        Ad hoc Enterprise Site Report [MAG ENTERPRISE]
        Delete Image Group [MAG SYS-DELETE IMAGEGROUP]
        Imaging Database Integrity Checker Menu ... [MAG DB IQ]
        Imaging Site Reports ... [MAG REPORT MENU]
        Importer Menu ... [MAG IMPORTER MENU]

You can also select a secondary option:

        DICOM Menu Options ... [MAGD DICOM MENU]
        Special Active User Excel output [XUSEC ISO ACTIVE USER EXTRACT]
        Validate DICOM Correct Information [MAG DICOM CORRECT VALIDATE]

Select Imaging System Manager Menu Option: IMPORTER MENU

        Build Outside Imaging Location file [MAG BUILD OUT IMG LOC]
        Check Outside Imaging Location file [MAG CHECK OUT IMG LOC]
        Display Studies to be Imported [MAG DISPLAY IMPORTER]

```

NOTE: Initially the Importer menus were only accessible if the user held the Vista option ‘MAG DICOM GATEWAY FULL’ but was changed during testing so users allocated the ‘MAG DICOM GATEWAY VIEW’ option could also access the Importer menu. For security reasons I think it should be noted in the documentation users only need to be assigned ‘MAG DICOM GATEWAY VIEW’ to access the Importer program, especially since importing will be done mostly by Radiology personnel.

8.11 Access to DICOM Gateway RPCs

The VistA system grants access to Remote Procedures based on a relation between certain menu options and the RPCs in question. The DICOM Gateway uses two classes of RPCs: those that can be called by any user of the DICOM Gateway (“view-only access”) and those that can only be called by end-users with “full access”. In order to support this distribution of privileges, the following two menu options are present in the VistA system and should be assigned to the appropriate personnel:

MAG DICOM GATEWAY VIEW
MAG DICOM GATEWAY FULL

Chapter 9 Archiving, Purging, Verifying, and Backup

9.1 Introduction

This chapter explains how to archive, purge, and verify VistA Imaging files and VistA Imaging FileMan entries. Image files are part of the patient's record and must be preserved for the required number of years. Image files may be kept online indefinitely. As image files get older and have not been accessed recently, they reside on the optical disk jukeboxes where they are still accessible to users, but access is less rapid. Some sites have taken platters out of jukeboxes for shelf storage, but these are reloaded when needed by a user. The state of the images on the storage devices and their relationship (through file references) to the VistA database require periodic verification.

9.2 Archiving and Purging of Image FileMan Entries

Entries in the IMAGE file (#2005) should NOT be purged or archived.

9.3 Archiving and Purging of Image Files

9.3.1 Automatic Image File Migration

The imaging workstation stores the full-size image file on the server when the image is captured. An abstract may be created by the capture workstation, or by placing an entry in the Abstract queue. An entry is placed in the JUKEBOX queue. The background processor then copies the images to the jukebox.

After a period of time during which an image is not accessed:

1. The full-size image will be deleted from the magnetic file server. It will still be accessible to users from the jukebox.
2. Next, the abstract will be deleted from the magnetic file server. If a subsequent request is made to display the full-size image or the abstract, that file will be copied back to the magnetic file server.

Because images are stored temporarily on the magnetic servers, these are referred to as VistA magnetic cache.

9.3.2 Purging RAID Shares

The Background Processor's Purge application clears disk space within the VistA Imaging shares. This space is necessary for newly captured files from Imaging modalities and the DICOM gateways. Space is also needed for files that are copied from the jukebox archive when images are viewed on Imaging display workstations.

Each file on every VistA Imaging shares is evaluated to determine if it should be purged, as follows:

- The file name must consist of the local namespace followed by the number which coincides with its IMAGE file (#2005) internal entry number. If the corresponding IMAGE file (#2005) entry does not exist, the image file is unconditionally purged from the VistA Imaging shares.
- The file location is checked against the IMAGE file (#2005) settings. If the IMAGE file (#2005) entry has no current magnetic cache pointers set for this image, then the IMAGE file (#2005) entry is updated, and the file is not purged. If no Jukebox pointer is set, then a Jukebox copy process is queued.
- If the image file in the VistA Imaging shares is not where the IMAGE file (#2005) specifies it to be, then the location pointed to by the IMAGE file (#2005) is checked. If a proper image file is found, then the redundant image will be otherwise purged.
- The image is next characterized as Patient Photo or non-Photo image for a patient by checking its image type. If so, the Photo ID's purge criteria parameters will be used in evaluating this image.
- If the image (a) is found to be at a magnetic location other than that specified by the IMAGE file (#2005) entry, or (b) is not found at an IMAGE file (#2005) alternate site, or (c) is confirmed of size non-zero on the jukebox, then the file will be removed from the VistA Imaging shares according to the purge criteria.

9.4 Queue Management

Failed and unprocessed queues are purged during the install procedures of the VistA Imaging System. Using the BP Edit|Queue Manager option on the main Background Processor form, one can update and manage queue file growth. After selecting a queue type and a queue status value, a list of the queues from eldest to most current will be shown with their status. The list will end at the current queue pointer. These reflect unprocessed (nil) and failed queues.

The user has the option of requeuing, purging or saving them to a file. These records reflect requests to move files to and from the jukebox with the exception of Abstracts and deletes.

Normally, a site would not consider requeuing jukebox-to-hard disk copies (JBTOHD queue) as these files usually reflect old requests that, for the most part, will no longer be useful. The Jukebox copies (JUKEBOX queue) may be requeued, however, the Purge process will automatically requeue those that are not currently archived on the jukebox.

Each queue task has an active queue pointer that designates the next entry to be processed. This queue pointer can be manually moved forward to begin processing at another location in the queue by using the Set Queue Partition context menu option within the BP Queue Manager. A typical situation may be when a queue entry is corrupted. Then the active queue pointer can be

moved to the next entry where processing will continue with the rest of the queue entries for that task. (See the *Background Processor User Manual* for more details).

9.4.1 Server Size

1. Select **View | Server Size** from the BP Queue Processor menu bar.

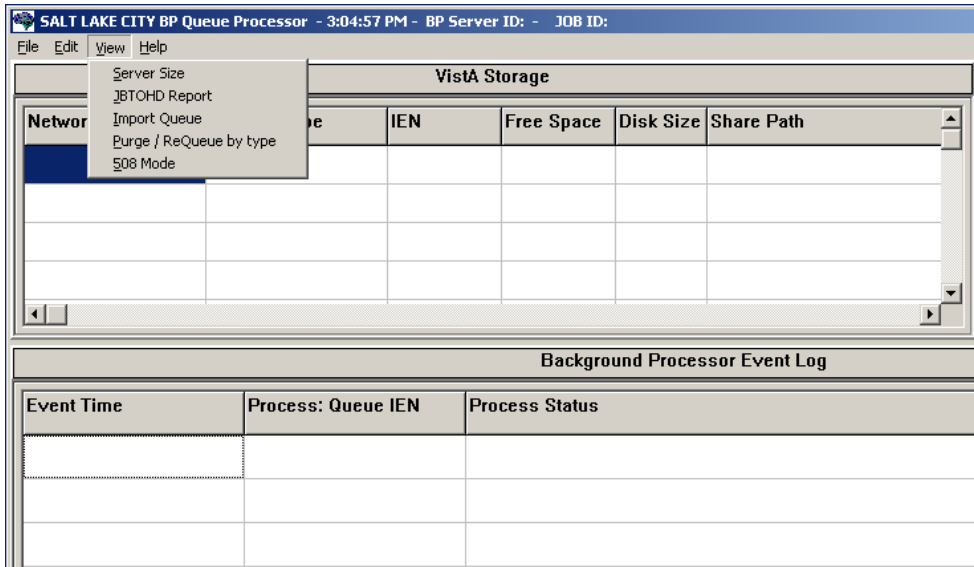

This window shows the amount of total space, free space and % Server Reserve space for RAID and jukebox shares as well as RAID Groups.

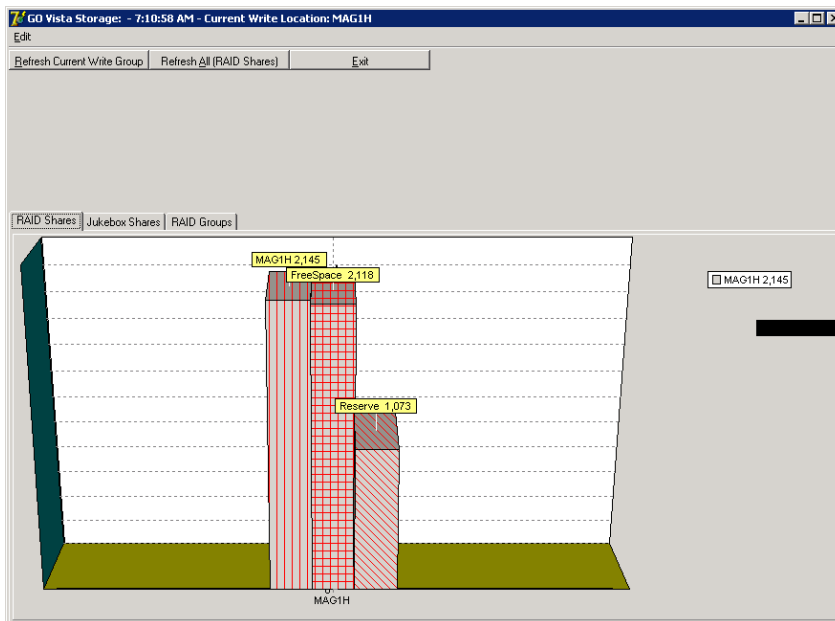

The Vista Storage area on the Queue Processor GUI can be refreshed with the most current storage utilization statistics for RAID Groups and RAID shares by clicking the buttons **Refresh Current Write Group** or **Refresh All (RAID Shares)**.

9.4.2 Background Processor: Open Log Functions

Log Files

New log files are created as HTML files at the beginning of every session. HTML files are viewable, printable, and searchable. By default, the BP Queue Processor log files reside in the following subdirectories:

- Queue Processor - C:\Program Files\Vista\Imaging\BackProc\log\BackProc
- Purge - C:\Program Files\Vista\Imaging\BackProc\log\purge
- Verifier - C:\Program Files\Vista\Imaging\BackProc\log\verifier

You can access these files by selecting **File | Open Log** on the BP Queue Processor menu bar and double-clicking the desired file.

Note: The log files can also be imported into an Excel spreadsheet.

Important: These files should be kept for historical/troubleshooting reasons and added to the tape backup process to safeguard the files. (See *Appendix B: Backups* in the *Vista Imaging System Installation Guide*.)

Log File Format

BP Queue Processor log files are archived as HTML files and have the year-month-day and sequence number imbedded in the file name, as shown in the right pane of the window in this example.

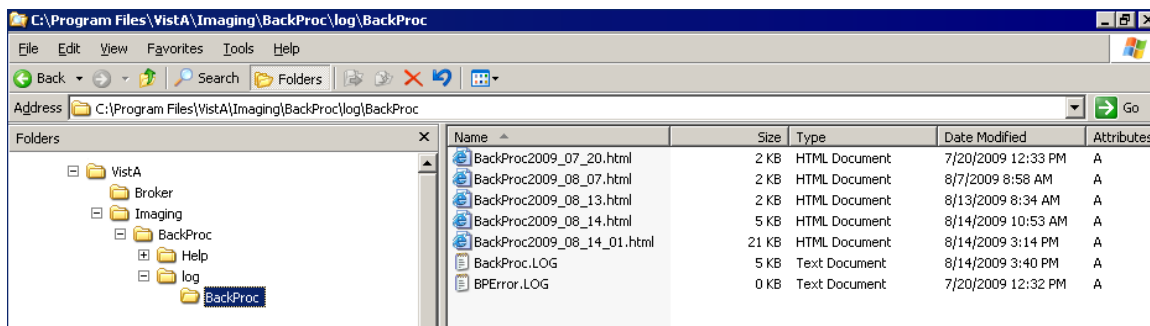

If more than one log file is created on the same day, the system appends a sequence number to the file name.

Queue Processor Log Files

The Queue Processor produces multiple log files for a processing run. Each file contains different information.

- BackProc Log

The BackProc.log file records all activity in the Event Log section in the Queue Processor window.

Date/Time	Event_Queue_Ref	Message/Path
10/29/2009 12:30:52 PM	BP Version	30.1.39.21
10/29/2009 12:30:52 PM	BP OS	Win Server 5.2.3790
10/29/2009 12:30:52 PM	Work Station	VHAIS\WHITV1
10/29/2009 12:30:52 PM	Vista Imaging Install	3 OP39
10/29/2009 12:30:52 PM	Vista BrokerServer	vhaia\whitem1
10/29/2009 12:30:52 PM	Raid Verify	Checking File Server Space
10/29/2009 12:30:54 PM	JukeBox:CacheSize	JBCache Percent Space Available: 98
10/29/2009 12:30:54 PM	Jukebox: 294	\\VHAIS\WHITV1\IMAGE\1\$D\M00111D\M001167.TGA \\VHAIS\WHITV1\IMAGE\EJB\1\$D\M001167.TGA
10/29/2009 12:30:55 PM	Jukebox: 294	Jukebox copy not overwritten.
10/29/2009 12:30:55 PM	JUKEBOX: 294	\\VHAIS\WHITV1\IMAGE\1\$D\M00111D\M001167.TXT \\VHAIS\WHITV1\IMAGE\EJB\1\$D\M001167.TXT
10/29/2009 12:30:55 PM	JUKEBOX: 294	TXT Not copied.
10/29/2009 12:30:55 PM	Jukebox: 294	\\VHAIS\WHITV1\IMAGE\1\$D\M00111D\M001167.ABS \\VHAIS\WHITV1\IMAGE\EJB\1\$D\M001167.ABS
10/29/2009 12:30:55 PM	Jukebox: 294	Jukebox copy not overwritten.
10/29/2009 12:30:55 PM	JUKEBOX:294	
10/29/2009 12:30:55 PM	% Server Reserve	Low Water Mark: % Free Space: 17.98%
10/29/2009 12:30:55 PM	JukeBox:CacheSize	JBCache Percent Space Available: 98
10/29/2009 12:30:55 PM	Jukebox: 295	\\VHAIS\WHITV1\IMAGE\1\$D\M00111D\M001168.TGA \\VHAIS\WHITV1\IMAGE\EJB\1\$D\M001168.TGA
10/29/2009 12:30:56 PM	Jukebox: 295	Jukebox copy not overwritten.
10/29/2009 12:30:56 PM	JUKEBOX: 295	\\VHAIS\WHITV1\IMAGE\1\$D\M00111D\M001168.TXT \\VHAIS\WHITV1\IMAGE\EJB\1\$D\M001168.TXT
10/29/2009 12:30:56 PM	JUKEBOX: 295	TXT Not copied.
10/29/2009 12:30:56 PM	Jukebox: 295	\\VHAIS\WHITV1\IMAGE\1\$D\M00111D\M001168.ABS \\VHAIS\WHITV1\IMAGE\EJB\1\$D\M001168.ABS
10/29/2009 12:30:56 PM	Jukebox: 295	Jukebox copy not overwritten.

Name	Description
Date/Time	Actual time when the IMAGE file (#2005) was processed
Event_Queue_Ref	Queue name and entry number and status check info
Message/Path	Description of action taken (or statistics for status checks)

- BP Error Log

The BPErrror.log file records error conditions with the operating system and Broker.

Date/Time	Event_Queue_Ref	Message/Path
3/30/2010 11:49:01 AM	GCC connection	NetConError
3/30/2010 11:49:01 AM	GCC connection	NetConError
3/30/2010 11:49:01 AM	GCC connection	NetConError
3/30/2010 11:49:01 AM	GCC connection	NetConError
3/30/2010 11:49:02 AM	GCC connection	NetConError
3/30/2010 11:49:02 AM	GCC connection	NetConError
3/30/2010 11:49:02 AM	GCC connection	NetConError
3/30/2010 11:49:02 AM	GCC connection	NetConError
3/30/2010 11:49:02 AM	GCC connection	NetConError
3/30/2010 11:49:02 AM	GCC connection	NetConError
3/30/2010 11:49:02 AM	GCC connection	NetConError
3/30/2010 11:49:03 AM	GCC connection	NetConError
3/30/2010 11:49:03 AM	GCC connection	NetConError
3/30/2010 11:49:03 AM	GCC connection	NetConError
3/30/2010 11:49:03 AM	GCC connection	NetConError
3/30/2010 11:49:04 AM	GCC connection	NetConError
3/30/2010 11:49:04 AM	GCC connection	NetConError
3/30/2010 11:49:04 AM	GCC connection	NetConError
3/30/2010 11:49:04 AM	GCC connection	NetConError
3/30/2010 11:49:05 AM	GCC connection	NetConError
3/30/2010 11:49:05 AM	GCC connection	NetConError
3/30/2010 11:49:05 AM	GCC connection	NetConError
3/30/2010 11:49:05 AM	GCC connection	NetConError

Name	Description
Date/Time	Actual time when the IMAGE file (#2005) was processed
Event_Queue_Ref	Error category
Message/Path	Description of error condition

Verifier Log Files

BP Verifier produces the following types of log files. For details on each log file, see the Verifier chapter in the *Background Processor User Manual*.

- Scan Log

The Scan log file lists entries with potential file integrity problems. The log records the operational events that take place to correct a particular problem. They are used to determine if and how the Verifier corrected the faulty condition. The IENs that the Verifier could not fix are listed in the ScanError log file.

- NoArchive Log

The NoArchive log file contains image file names that are missing on the jukebox and could not be created from existing files and/or could not be found on the RAID. The Verifier examines both the IMAGE file (#2005) and the IMAGE AUDIT file (#2005.1) for missing files. The 2005.1 column shown below indicates those missing files that have been deleted and the IMAGE file (#2005) record has been moved to the IMAGE AUDIT file (#2005.1).

- ScanError Log

The ScanError log file lists problems with IENs that could not be corrected. When a Verifier scan is completed, the contents of this file are sent as a mail message to the MAG SERVER mail group.

- DFNError Log

The DFNError log file displays integrity issues with patient data.

Purge Log Files

BP Purge produces the following types of log files. For details on each log file, see the Purge chapter in the Background Processor User Manual.

- Purge Log

The Purge.html log file records the current share being purged as well as all of the successful deletions and the reason they were deleted.

- PurgeError Log

The PurgeError.html log file records the current share being purged as well as all of the files that were not deleted and the reason they were not deleted.

9.4.3 Check Status of the JBTOHD Report

1. On the Background Processor main menu, select the **View | JBTOHD Report** option.
2. Select **File | Refresh** in the report window.

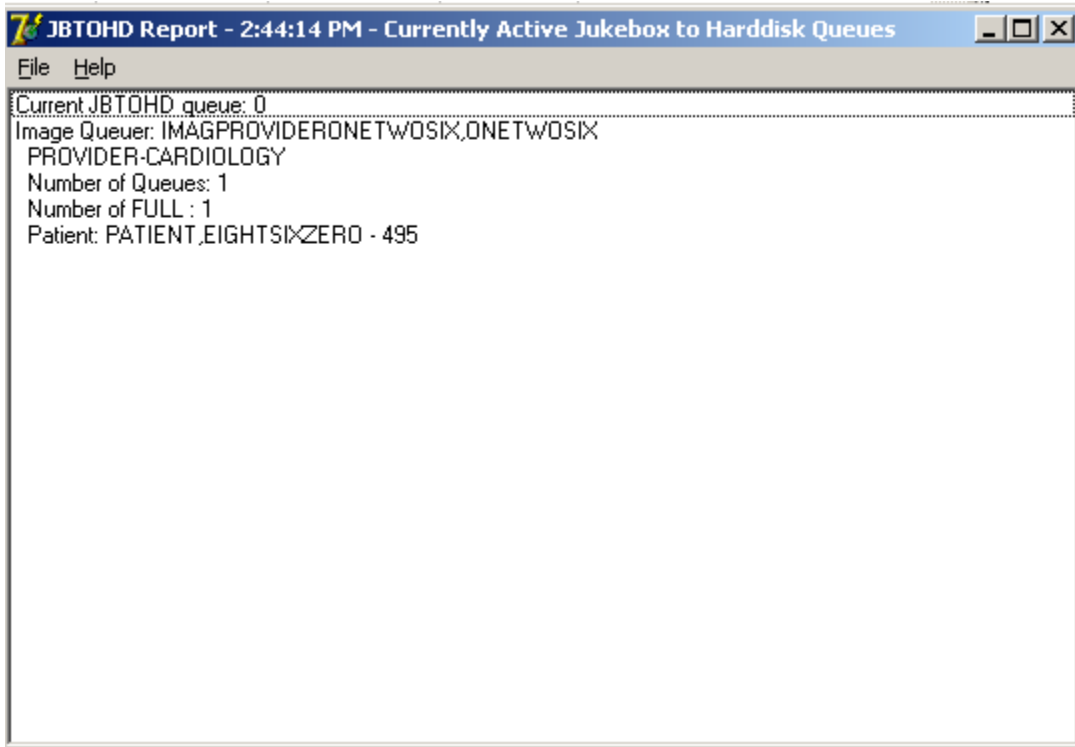

The JBTOHD queue display is sorted by the individual that queued the entry. It displays the number and types of queues. It displays the patient along with the queue Internal Entry Number (IEN) to facilitate advancing the queue pointer.

9.5 Background Processor Configuration Tools

9.5.1 Configuring BP Servers

Guidelines

- At least one BP Server must be present to perform utility functions such as copying image files to and from Imaging servers (the RAID shares) and the archive (the jukebox share).
- The software does not permit redundant task assignments of BP activities. For example, you cannot specify that more than one BP Server perform the JUKEBOX task.
- The JUKEBOX and DELETE tasks should run on the same BP server. If not, the DELETE queue may be processed in advance of the image being written to the jukebox, and the DELETE queue will eventually fail. These failed queues must be re-queued.

- The IMPORT and ABSTRACT tasks must run on the same server. There will be occasional archived FULL files that do not have abstracts. If you see these ABSTRACT tasks failing, the JBTOHD task should be added to server running the IMPORT/ABSTRACT task. Please note the IMPORT can execute on a single server.
- If the Verifier and Purge are to be run on servers other than those running the Queue Processor tasks, a new BP Server must be configured for those tasks.
- When the PREFET task is added to the VistA Imaging Display workstation configuration, this activity task must be checked assigned on the BP Server configuration window in order to have these queue types processed.
- A directory can be created on the RAID shares or remote storage location to archive BP log files for later reference.

Adding a BP Server to the VistA Imaging System

Running multiple BP servers improves performance and redundancy by allowing the distribution of tasks, and allowing queues to be quickly reassigned in the event of a failure. Therefore, it is recommended that at least two BP servers be up and running. Though the facility may choose any server to host the BP (as long as the server meets the minimum requirements), an ideal location is directly on the two Image Cluster nodes.

To Set Up a BP Server Application

1. From the BP Queue Processor menu bar, select **Edit | BP Servers**.

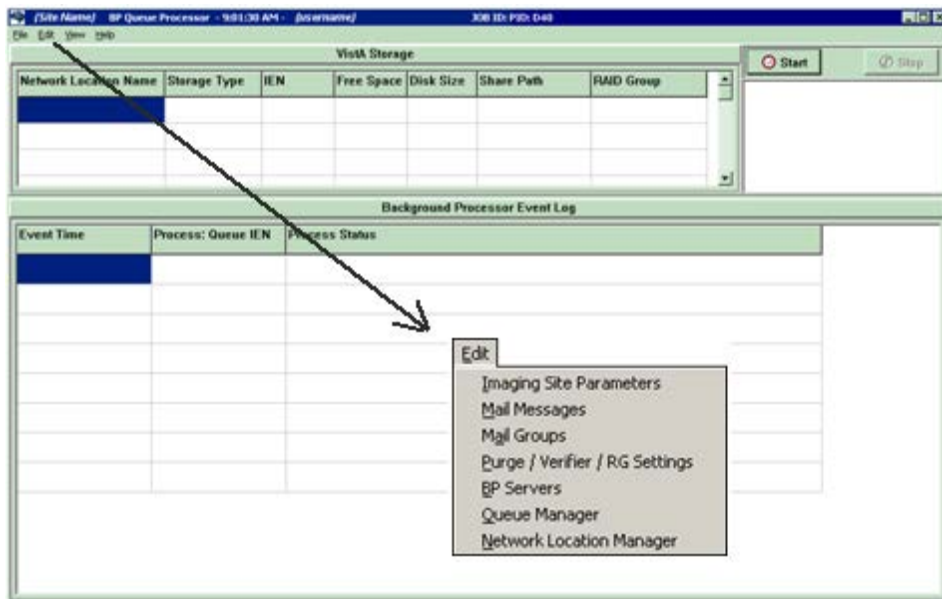

The BP Server Parameters window enables you to create a unique server name for a server and assign tasks to that server. The properties on these servers enable you to

specify the location of the log files for all applications on each BP Server and the file's size limit (described in “*Specifying the Log File Location and Size*” in the *BP User Manual*.)

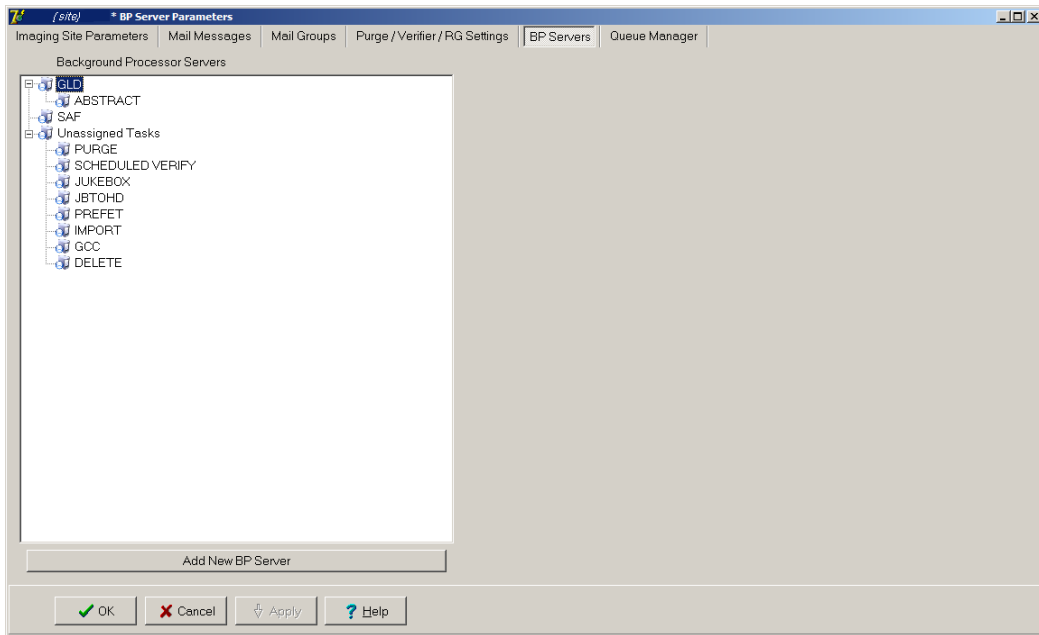

2. Click the **Add New BP Server** button at the bottom of the tree pane.
3. In the BP Server Add dialog box displayed, enter a logical name for the BP Server such as **BP1**.
Note: The name must be at least three characters in length and can contain alpha and numeric characters and must be unique. Once the name is saved, it cannot be renamed. It can only be deleted when all the tasks assigned to it are removed.

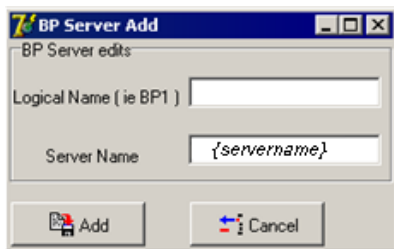

If the name is not valid, an error message is displayed. You can correct the name and repeat the steps.

Assigning Tasks (Queues) to a BP Server

By default, no tasks are assigned to BP Servers. The tasks will need to be assigned in order for that function of the BP software to operate. You can assign tasks based on the needs of your facility. As previously mentioned, a queue name identifies the task that the Queue Processor performs. All queues are available for you to assign to a BP Server, except EVAL.

Note: You should assign Purge as well as the Scheduled Verify to BP Servers. These features help maintain the system's free-space and integrity without operator intervention.

1. Drag and drop a task from the Unassigned Tasks in the tree pane (shown) to the server that is designated to run that task.

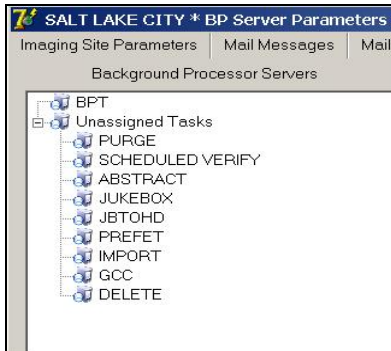

Note: The priority of tasks running on the same server is set internally and cannot be changed. The functions of each task are:

- 1) JBTOHD - populates the VistA Imaging shares with images that have been deleted from the RAID shares through the Purge function.
 - 2) PREFET - populates the VistA Imaging shares with images that were requested based on VistA Imaging Display workstation configuration parameters.
 - 3) ABSTRACT - creates ABS derivative thumbnail files from FULL/BIG files when the file type is missing on the RAID shares and archive (jukebox)
 - 4) IMPORT - provides a means for external applications to archive images in the VistA Imaging environment.
 - 5) JUKEBOX - copies images to the long-term archival storage device
 - 6) DELETE - removes images from the VistA Imaging shares.
 - 7) GCC - exports images to a share that is external to the local VistA Imaging network.
 - 8) PURGE – This assignment includes both the auto purge and the scheduled purge tasks. Refer to the purge section of this document for more details.
 - 9) SCHEDULED VERIFY – automatically runs the Verifier at the assigned time to check the integrity of the Image records in VistA with the file locations on RAID and archived storage. Only the most recent unchecked IENs are verified.
2. Click **Apply** to save the changes or **OK** to save the changes and exit.

Removing a BP Server from the VistA Imaging System

1. From the Queue Processor menu bar, select Edit | BP Servers.
2. In the tree pane, right-click the server name and select Delete BP Server from the popup menu displayed.

Note: This popup menu can also be accessed from the keyboard by using Shift + F10.

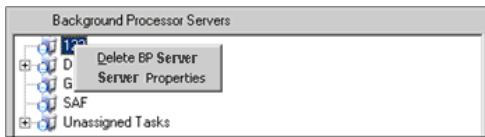

The selected BP Server is removed from the tree pane.

Note: This same name can be added later.

Specifying the Log File Location and Size

1. Click a BP Server name in the tree pane and select Server Properties from the popup menu displayed.

Note: This popup menu can also be accessed from the keyboard by using Shift + F10.

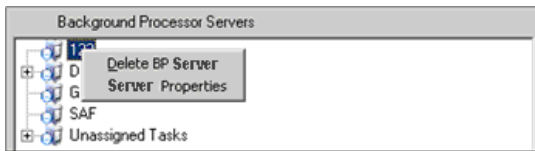

The BP Server Properties dialog box is displayed.

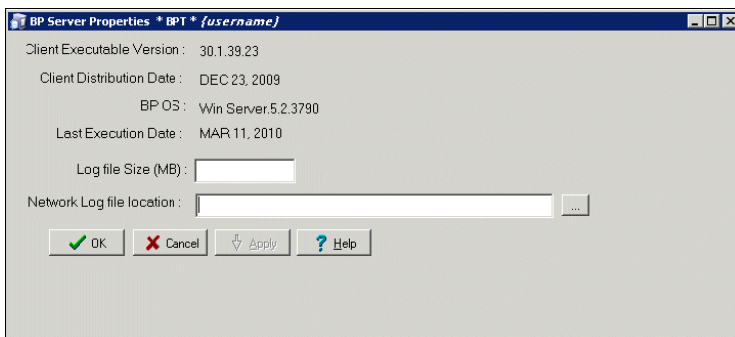

2. Enter the size in megabytes in the Log File Size field.

The default log file size limit is 2 MB.

3. Specify the Network Log file location on a local machine or a remote network location.

Note: By default, the log files are created on the local drive in the directory Program Files\Vista\Imaging\BackProc\Log. If a remote network location is entered, the Background Processor must have Read and Write access to it. Use the \\computer name\share name format and do not use a letter drive for the remote network location.

4. Click **OK** to save the information and close the window.

9.5.2 Background Processor Purge Configuration

The BP Purge / Verifier / RAID Group Advance Settings window is used for setting up the Scheduled Verifier, Scheduled Purge, and RAID Group Advance activities. In addition, the parameters for the Purge activity are set up through this window.

Selecting the Edit | Purge / Verifier / RG Settings menu in the Queue Processor window opens the BP Purge / Verifier / RAID Group Advance Settings window.

Purge Settings

The Purge process is used to remove image files from the RAID when the free space is low or when older and/or not recently viewed image files can be purged to allow room for newly acquired images. It is important to note that no file is purged from the RAID shares if it has not been verified and confirmed as saved on the archive storage (jukebox).

The Purge can be run manually in standalone mode or as a part of the Queue Processor. The Purge Parameters are used to control the purge activities in auto, manual and scheduled modes.

Guidelines for Setting Retention Days on Files for the Purge

General guidelines:

- Determine the span of dates of images that will be preserved on the **Imaging shares**.
- The shorter the timeframe, the more space will be free on the RAID when the purge completes.
- Multiple purges may be required to determine the retention days. It is advisable to start with one share with a large retention days value.
- Not all sites capture all the file types specified in the parameter list (e.g. BIG, Photo ID).
- If the frequency and the results of purging are acceptable, then it is not advisable to change the Purge values.
- If there is still not enough free space after the purge, decrease the Retention Days in Purge Parameters (BIG and FULL files, in particular) and repeat the purge until the desired free space is obtained.

Factors that determine the best set of purge parameters for an individual site are:

- The frequency of purges
- The volume of image acquisition rate
- The volume of image file retrieval
- The use of Pre-Fetch
- The capacity of disk space for VistA Imaging RAID shares

Some sites have extended their RAID capacities and are able to maintain five or more years of images on the shares. These sites may only need to purge once per year to purge off the latest year of images (year 6). Others who have smaller RAID sets have to purge more frequently and can only have a limited amount of images on their shares.

For your site, strive to keep the shares between 80% and 90% full (or between 10% and 20% free space). When the Purge process completes and the resulting free space is in excess of this values, then adjust the parameters accordingly.

Configuring the Retention Days Settings

Retention Days		Retention Dates	
Full Files	90	5/15/2009	
Big Files	45	6/29/2009	
Abstract Files	120	4/15/2009	
Photo IDs	99999	10/30/1735	

Field or Checkbox	Description
Retention Days and Retention Dates box	
Full Files	<p>Source: Images from the DICOM Gateways, Clinical Capture workstations and Imports</p> <p>File extensions: 756,ASC,AVI, BMP,BW,DCM, DOC, HTM, HTML, JPG, MHT, MHTML, MP3, MP4, MPEG, MPG, PAC, PDF, RTF, TGA, TIF, WAV</p> <p>Range: 0 - 99,999 (number of days back from the current date that files should be retained)</p>
Big Files	<p>Source: Images from the DICOM gateway and Clinical Capture workstations.</p> <p>File extensions: BIG</p> <p>Range: 0 - 99,999 (number of days back from the current date that files should be retained)</p>
Abstract Files	<p>Source: Images from the DICOM gateways, Clinical Capture workstations and Imports. Abstract files are derivatives of the TGA/BIG format files.</p> <p>File extensions: ABS</p> <p>Range: 0 - 99,999 (number of days back from the current date that files should be retained)</p>
Photo IDs	<p>Source: Source: Patient photo images from the Clinical Capture workstations.</p> <p>File extension: JPG</p> <p>Range: 0 - 99,999 (number of days back from the current date that files should be retained)</p>

1. Enter the number of days that each of the four file types above should remain on the shares based on the purge date criteria in the section *Configuring Purge Date Criteria Settings*.

Note: The FULL and BIG files are typically larger file sizes and consume more free space on the shares than the abstracts and photo IDs.

2. As a result of different file type sizes, set fewer retention days for the larger file to free more space.
3. Because the abstracts and photo IDs are smaller files, set the retention days for purging these two types of files to a higher value than the values for the FULL/BIG file retention days.

- Because the abstract files are viewed as thumbnails on the Clinical Display workstation, set the retention days to retain a minimum of 5 years (1,825 days) on the shares regardless of the capacity of the RAID to make viewing on the Clinical Display workstations more efficient.

Configuring Purge Date Criteria Settings

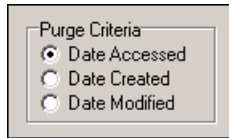

Purge Criteria	
Date Accessed	Date when the file (image) was last viewed on a VI workstation
Date Created	Date when the file was copied to the current disk share
Date Modified	Date when the file was last changed. On the initial save, the Date Created will be the same as the Date Modified.

Any of the three file date/times can be used (date accessed, date modified, date created) to purge the shares. There have been instances where third party utilities have changed the access dates on all the files it “touched” to the same recent date.

When the purge is activated, no files are deleted as none of the file access dates are purge candidates. It is recommended that the Date Modified be used. This date is retained when files are moved across storage media and is a reliable date for purging.

Configuring Scheduled/Express Purge Settings

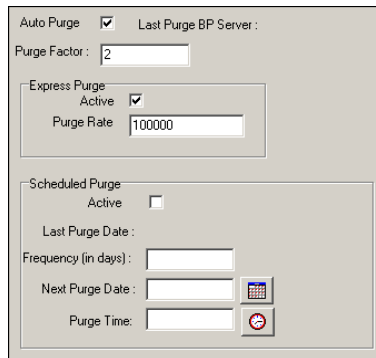

Field or Checkbox	Description
Auto Purge	Enables the Purge to run when the high water mark is reached on a RAID Group. Important: Auto Purge should always be enabled.
Last Purge BP Server	BP Server on which the last purge was run

Field or Checkbox	Description
Purge Factor	Multiple of the % Server Reserve (found on the Imaging Site Parameters window). When the free space falls below value of the % Server Reserve times the purge factor, a purge is initiated on the next available online RAID Group. The default value of the purge factor is 2.
Express Purge Section	
Active	Enables an Express Purge
Purge Rate	When the number of image entries that have been evaluated for purging (based on the date criterion), without deletion, the purge process for that share will cease. The default Purge Rate value is 100,000.
Scheduled Purge Section	
Active	Enable scheduled purges
Last Purge Date:	Date when the last purge was run
Frequency (in days)	The number of days added to the Last Purge Date to determine the next Scheduled Purge Date. If this field is left blank, the Scheduled Purge can be scheduled for a single event. When the event takes place, the Next Purge Date is cleared.
Next Purge Date	Next scheduled Purge date
Purge Time	Time of day for the next scheduled Purge

Note: Before an automatic purge is set up, a manual purge should be run on a share to make sure the Purge Parameters are set properly.

The automatic purge will use these same Purge Parameters and if not set properly, will result in unsatisfactory results. As the volume of images increases from the gateways, etc, these parameters should be adjusted to compensate for the increase.

Scheduled purges typically are set up on a monthly basis, but this will vary per site. The goal is to keep the shares between 80% and 90% full. Some adjustments in scheduling will need to be made after a scheduled purge cycle has completed.

Enabling Express Purge will greatly enhance the purging process by eliminating unnecessary file traversals that are not candidates for purging and thus significantly decrease the time to purge a share. The Purge Factor is set to control when the purge on a share is terminated. When the number of files that are traversed and not deleted has exceeded the number in the Purge Factor, the purge stops on that share and begins purging the next share (automatic mode).

9.5.3 Network Location Manager: Adding a New Magnetic or Jukebox Storage Location and other Storage Types

Note: The following procedure applies to all the tabs in the Network Location Manager window.

1. From the Queue Processor menu bar, select **Edit | Network Location Manager** to open the following window.

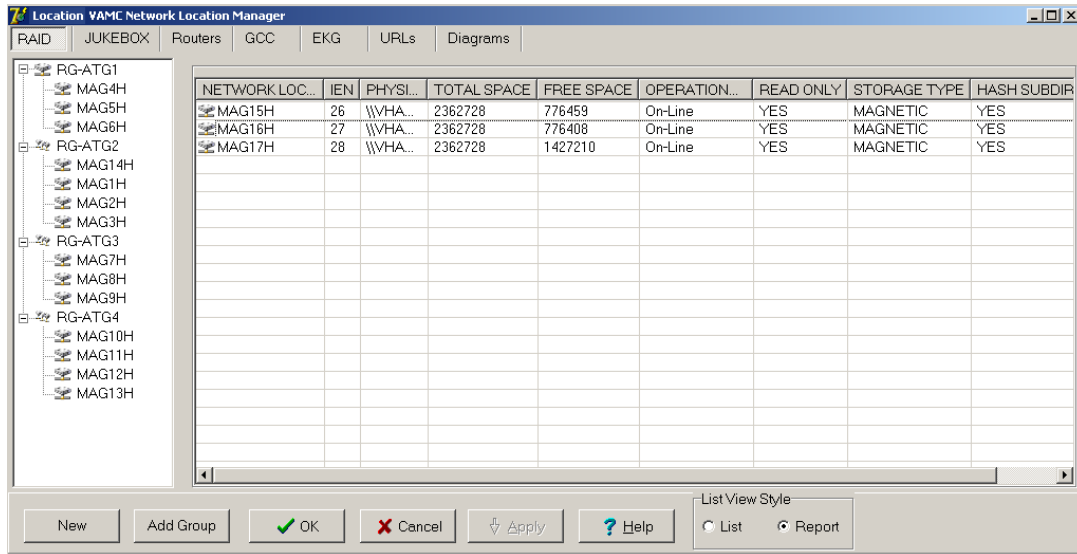

The RAID tab is automatically selected.

2. To add a new network location, click the **New** button at the bottom. The Network Location Properties window will be displayed.

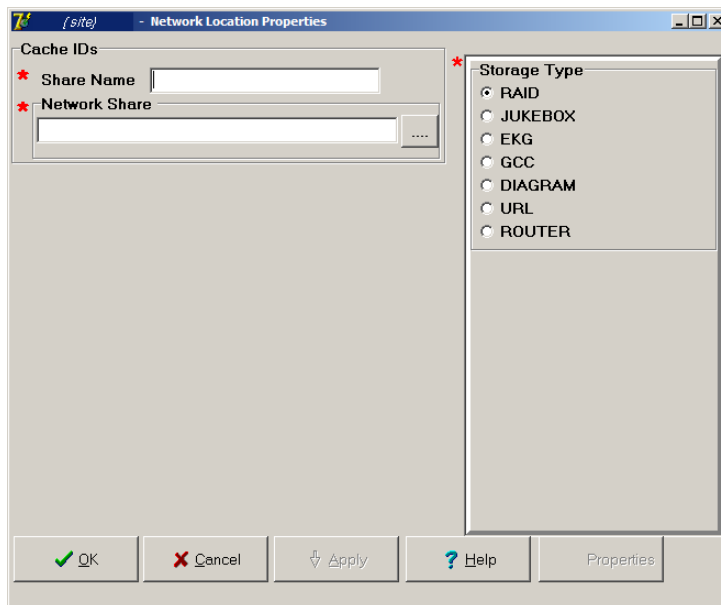

3. Type the Share Name.

4. At the Network Share field, either type the path to the location where images are to be stored, or click the **browse (...)** button and specify the path.
5. Select the appropriate option at the Storage Type field.
6. Click **Apply**.

Additional fields relevant to the storage type are displayed. The example below is for Storage Type RAID only.

Note: The STORAGE TYPE field is preselected depending on the Network Location tab selected. If the EKG tab is selected, then the STORAGE TYPE will be set to EKG, and so forth. However, the preselected value can be modified.

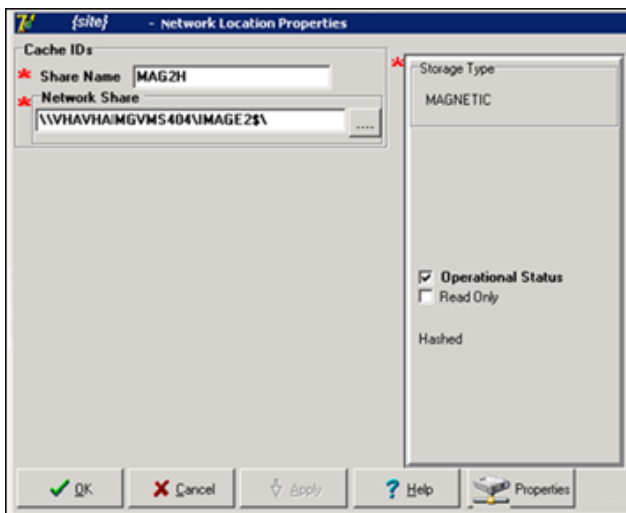

7. Leave the **Operational Status** check box selected by default setting, or clear it.
8. Leave the **Read Only** check box cleared by default setting or select it.
9. Click **Apply** to add the changes to the database or click **OK** to add the changes and exit.

9.5.4 Background Processor Imaging Site Parameters Edit Functions

Imaging Site Parameters Window

The Edit | Imaging Site Parameters menu on the Queue Processor menu bar opens the Imaging Site Parameters window used to modify and save parameters in the VistA database. Each of the boxed areas in the window is described below.

The screenshot shows the 'Imaging Site Parameters' dialog box with the following sections and fields:

- Administrative:**
 - Current Namespace: SLC
 - RAID Write Location: MAG4H
 - Generic Carbon Copy: GCC1
 - Current RAID Group: RG-SLC3
 - Import Queue Security:
 - Site Code: DDD
 - Associated Institutions: COLUMBIA, MO; SALT LAKE, UT
 - VistARad Grouping: COLUMBIA, MO; KANSAS CITY, MO
- Clinical Workstation:**
 - Use Capture Keys:
 - Timeout Windows Display: 60
 - Timeout Windows Capture: 45
 - Timeout VistARad: 60
 - Default MUSE Site #: 14
 - Default User Preference: LASTNAME, FIRST (SETTING 1)
- Storage Functions:**
 - Jukebox Write Location: WORMOTG {site name}
 - % Server Reserve: 8
 - Auto Write Location Update:
 - Multiple Namespace: CHA, DM
 - File Types: PDF, TXT
- Service Accounts:**
 - Windows Username: vhamasterBPUser
 - Windows Password: [masked]
 - VistA Access: [masked]
 - VistA Verify: [masked]
- DICOM interface:**
 - DICOM Gateway Write Location: MAG4H
 - DICOM Gateway Interface Switch Update:
 - Retention Days HL7 - Modality Worklists: 30
 - % Free Space DICOM Messages: 15
 - Retention Days DICOM Messages: 123
- Telereader:**
 - Net Site Service: VISTASITESERVICE
 - Timeout TeleReader: 121

Buttons at the bottom: OK, Cancel, Apply, Help.

Administrative Settings

Field or Checkbox	Description
Current Namespace	Each VHA facility has its own unique 3-character designator. The Current Namespace file is used to store this 3 letter facility designator. It is used in Imaging as the first 3 characters of the 14-character name given to image files captured at this site. The VistA Imaging development and support teams maintain a central database with each sites 3 letter designator. The Current Namespace field is not configurable. This is necessary to ensure that image file names across VHA are unique.
RAID Write Location	All images from the gateways, Capture, etc. will be written to this share. The selected Current RAID Group determines which shares are listed on this dropdown list.
Generic Carbon Copy	Remote share where files will be exported. The share permissions must match the login credentials for the BP Server.
Current RAID Group	The current active RAID Group includes the RAID Write Location (described above). When new images are processed, they are stored on the RAID Write Location share within this group. The RAID Groups are set up with the Network Location Manager.
Import Queue Security	Checks users Imaging security keys for permission to capture images
Site Code	Three-letter acronym for the site location. This is used for AutoRouting and MUSE.
Associated Institutions	This set of institution values will allow users from other institutions to access local images. Note: Right-clicking this field displays an Add/Delete popup menu that can also be accessed from the keyboard by using Shift + F10.

Field or Checkbox	Description
VistARad Grouping	The radiologist can lock/interpret exams for other divisions (including the Parent Institution or other Associated Institutions), when those divisions are included in this set of institutions. Note that this setting controls exam locking and updating, as well as filtering of the UNREAD Exams lists to show only the Institutions that are defined here. Note: Right-clicking this field displays an Add/Delete popup menu that can also be accessed from the keyboard by using Shift + F10.

Storage Functions Settings

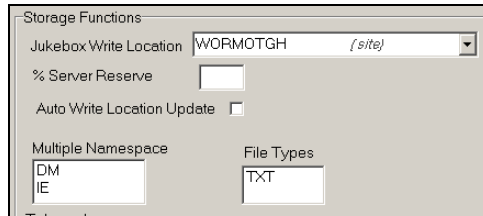

Field or Checkbox	Description
Jukebox Write Location	Jukebox share where newly acquired images are currently being written.
% Server Reserve	The purpose of the reserve is to provide a significant amount of reserved primary storage to allow time for corrective action to create more space on the shares. Enter an integer between 1 and 50.
Auto Write Location Update	At the interval of every 20 minutes or 100 images written to a share, the Queue Processor will determine which share within a group has the most space and will use that share as the current write location for newly acquired images. To manually select a RAID Write Location, uncheck the Auto Write Location Update box. Images will be written to the selected RAID share until it is filled or manually changed to another share.
Multiple Namespace	List of all the legacy namespaces that have been used at a site and are reflected in the filenames on the RAID and jukebox shares. Note: Right-clicking this field displays an Add/Delete popup menu that can also be accessed from the keyboard by using Shift + F10.

Field or Checkbox	Description
File Types	File extensions outside of the standard extensions that the BP products will recognize and treat as a standard extension file. Note: Right-clicking this field displays an Add/Delete popup menu that can also be accessed from the keyboard by using Shift + F10.

TeleReader



Field or Checkbox	Description
NET SITE SERVICE	The web service used by Remote Image Views to gain access to remote sites
Timeout TeleReader	The number of minutes that the TeleReader application will remain active before closing due to inactivity. If this field is undefined, the application will not timeout. Max value is 999999, no decimals allowed.

Clinical Workstation Settings

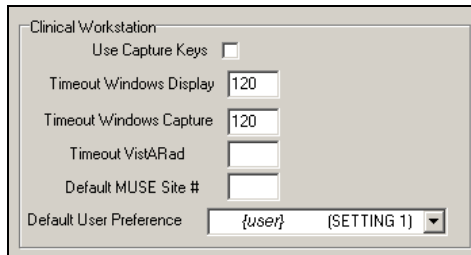

Field or Checkbox	Description
Use Capture Keys	Check users' Imaging security keys for permission to capture images.
Timeout Windows Display	Number of minutes until the Imaging Display application will close due to inactivity. The default setting is 120 minutes (Range 6 to 600).
Timeout Windows Capture	Number of minutes until the Imaging Capture application will close due to inactivity. The default setting is 120 minutes (Range 6 to 600).
Timeout VistARad	Number of minutes until the Imaging VistARad application will close due to inactivity. There is no default setting.

Field or Checkbox	Description
Default MUSE Site	MUSE site number that the Imaging Display application will connect to. Site numbers are usually 1, 2, 3, If left empty, the field defaults to 1.
Default User Preference	A specified user's parameter settings will be used for first-time users of the Imaging system.

Service Accounts Settings

These credentials are shared between the DICOM Gateway, Image cluster, Jukebox Server, and Background Processor.

Field or Checkbox	Description
Windows Username	Content removed: FOIA exemption b2/high 2
Windows Password	Domain password used to access the Imaging shares on the RAID and archive (jukebox) share.
VistA Access	Encrypted access code for the Imaging Service Account in VistA. This account will be used to automatically re-log into the application when there is a loss of connectivity between the BP product and the Broker (VistA). Note: The Imaging Service Account must have the MAG SYSTEM security key and secondary menu option MAG WINDOWS. The VERIFY CODE never expires. This user must have a single division designation.
VistA Verify	Encrypted verify code for the Imaging Service Account in VistA. This account will be used to automatically re- log into the application when there is a loss of connectivity between the BP product and the Broker (VistA).

DICOM Interface Settings

Field or Checkbox	Description
DICOM Gateway Write Location	RAID share where newly acquired images are currently being written.
DICOM Gateway Interface Switch Update	Indicates presence of a DICOM Gateway on the system.
Retention Days HL7 – Modality Work Lists	<p>This field is used as the default value, in days, by the DICOM Text Gateway for three different user menu driven purges:</p> <ul style="list-style-type: none"> • This field is used by the Purge Old Modality Worklist Entries menu option to determine the number of retention days from the date of creation of Modality Worklist Entries. • This field is used by the Purge Old DICOM Message Files menu option to determine the number of retention days from the date of creation of DICOM messages that were sent to commercial PACS. • This field is used by the Purge Old HL7 Transaction Global Nodes menu option to determine the number of retention days from the date of creation of HL7 messages sent from VistA to the DICOM Text Gateway. <p>Note: This value may be overridden by the user when executing any of these menu options.</p>
% Free Space DICOM Messages	Minimum percentage of free disk space for DICOM HL7 messages on the text gateway. A typical value is 25%.
Retention Days DICOM Messages	Number of days to retain DICOM HL7 messages on the text gateway, 30 days is recommended.

9.5.5 Scheduled BP Verifier

The Scheduled Verifier should be set up to run nightly. It will verify the integrity of any image records not validated since the previous Verifier run (Manual or Scheduled). It is suggested that the Verifier be run manually over the entire range of image records before incremental Verifier runs are started. The application that runs for the Scheduled Verifier is the same as the Manual Verifier. Reference the Manual Verifier in the BP User Manual for specific information about the GUI and log files.

9.5.5.1 Guidelines for Setting Parameters for the Scheduled Verifier

The following guidelines for using the Scheduled Verifier will help maintain the integrity of the Imaging records in the VistA database.

Important: If the PC that has Scheduled or Auto events is not a server class, the task will not start.

- Set the Active check box to enable scheduled runs of the BP Verifier. The scheduled runs of the Verifier will only check the most recent VistA records of new images that have been created since the last Scheduled Verifier run.
- Do not select the Check Text Files check box. The contents of the text files on RAID will be compared to the information in VistA. This processing will slow down the Verifier processing and utilities are not available at the present time to correct any issues that surface.
- The Last Verifier Date field is set by the system and cannot be set by the user.
- When the Active parameter is checked, the Frequency (in days) field setting should be 1 so that the Verifier runs daily.
- Initially set the Next Verifier Date to today's date. The scheduling frequency will be based on this date.
- Set the Verifier Time to an inactive period of the day –typically after hours when image creation activity is low.

Description of the Scheduled Verifier Settings

Last Verify BP Server :

Scheduled Verifier

Active

Check Text Files

Last Verifier Date:

Frequency (in days) :

Next Verifier Date: 

Verifier Time: 

Field or Checkbox	Description
Last Verify BP Server	BP Server on which the Verifier was last run (Display only, set by application)
Scheduled Verifier	
Active	Enables scheduling the Verifier
Check Text Files	Read text files on the RAID shares and determine if: <ol style="list-style-type: none"> 1) the file is binary or unreadable 2) there are unprintable characters in the file 3) The SSN does not match the one in VistA 4) SOP Instance UID mismatch with VistA 5) Study Instance UID mismatch with VistA 6) SOP Instance UID and/or Study Instance UID are blank 7) SSN in the top part of the text file does not match the bottom.
Frequency (in days)	Number of days added to the date of the last time the Verifier application ran to determine the next time the Scheduled Verifier should be run.
Last Verifier Date	Date when the Verifier was last run
Next Verifier Date	Date of the next scheduled Verifier will run based on the Frequency (in days) parameter
Verifier Time	Time of day when the Verifier will run

9.5.5.2 Setting Up the Scheduled Verifier

Use the guidelines above to set up the Scheduled Verifier.

1. Select **Edit | BP Servers**.
2. Drag the SCHEDULED VERIFIER task on the BP Server to the location where the Verifier is to be run.
3. Click **OK** to close the window.
4. Select the **Edit | Purge / Verifier /RG Settings** tab.
5. Set the following fields in the Scheduled Verifier box:

Field	Setting
Active	Checked
Check Text Files	Unchecked
Frequency (in days)	1
Next Verifier Date	(starting date)
Verifier Time	(time of day the Verifier will run – after hours is best)

9.5.6 Scheduled RAID Group Advance

The RAID Group Advance is configured on the Imaging Site Parameters window. RAID groups are used to organize RAID shares into logical groups for easy tape backup and restore processing. During the install, all existing online Imaging shares are placed into the first RAID Group, RG-XXX1. This configuration is the same and has been in existence for past years. The Auto Update functionality is also the same. At regular intervals, the current write location will change to the share with the most free space. The Auto-Write function will reset the current write location to provide load balancing within the RAID group. When the % Server Reserve within the group has been reached, the Auto-Write will set the next RAID group as the current write group. In addition, when the used space in that RAID group has reached the high water mark, the next RAID Group that has online shares will become the current RAID group.

9.5.6.1 Guidelines for Setting Parameters for the Scheduled RAID Group Advance

Sites can choose a configuration that suits them best, as follows:

- Use the initial configuration where all the shares are in the same RAID Group. The new images will be evenly distributed among all the shares.
- Nightly incremental tape backups, as well as monthly/quarterly tape backups, must be done on a regular basis on all the shares.

- Distribute the shares among multiple RAID Groups. Fill the shares in each group to the Server Size, and then switch the current write group to the next. New image files will be distributed over all the shares assigned to that group.
- Nightly incremental tape backups, as well as monthly/quarterly tape backups, must be done only on that RAID Group.
- When the RAID group has reached capacity, a final full backup should be done on all of that RAID group’s shares. Nightly incremental tape backups and monthly/quarterly tape backups should be started on the next current write group.

Scheduled RAID Group Advance Settings



Field or Checkbox	Description
Active	Enable RAID Group Advance scheduling
Last RAID Advance	Date when the last scheduled RAID Group Advance occurred
Frequency (in days)	Number of days added to the date of the last RAID Group Advance to determine the next time the RAID Group Advance will run. If the Frequency parameter is set, the next RAID Group Advance will be scheduled automatically. If the frequency is not set, no automatic scheduling will occur.
Next Advance Date	Date of the next scheduled RAID Group Advance
Advance Time	Required. Time of day of the next scheduled RAID Group Advance

9.5.6.2 Setting Up the Scheduled RAID Group Advance

This option is applicable when there are multiple active RAID Groups. Use the guidelines above to set up the Scheduled RAID Group Advance.

1. Select the **Edit | Purge / Verifier /RG Settings** tab.
2. Set the following fields in the Scheduled RAID Group Advance box:

Field	Setting
Active	Checked

Frequency (in days)	Set by determining how long a span of time images will be written to a set of shares in a Group.
Next Advance Date	Set the starting date when the system will move to the next RAID Group.
Advance Time	Set the starting time of day when the system will move to the next RAID Group.

3. Click **OK** to close the window.
4. Click **Start** on the Queue Processor main window.
(A Queue Processor must be in the running state in order for the RAID Group Advance to run on the designated server.)

9.6 Background Processor Image and File Entry Verifier



As a separate executable, it is necessary to launch the Verifier application from the Programs menu, unless you set up a desktop shortcut. The executable is installed by default in the program files/vista/imaging/backproc subdirectory.

The process examines each non-group entry within the selected range of IMAGE file (#2005) entries. It searches each network magnetic and jukebox share indicated by each IMAGE file (#2005) entry for all extensions of the indicated filename. For each, it does the following:

- When more than one jukebox share contains images of the same file name, the Verifier will aggregate those files on a current jukebox share entry location. It will update the JB references in the IMAGE file (#2005) entry and IMAGE AUDIT file (#2005.1) entry. The Activity column of the Verifier will display this activity as “Aggregate”.
- If any extension of the image file is missing from the referenced jukebox share and is both referenced and available on the Vista Imaging Shares, then the Verifier will copy it to the jukebox share and update the appropriate jukebox IMAGE file (#2005) references.
- If the Vista Imaging Shares references in the IMAGE file (#2005) entry are not accurate and the appropriate files are available at another network location, then the Vista Imaging Shares references are updated.
- If there is no TGA or ABS file on the network, but a BIG file exists, then the Verifier will create the missing file(s) at the current network write location, aggregate it to the jukebox, and update the image file jukebox references.

9.7 Imaging Server and Jukebox Backup Information

Sites should establish weekly and daily schedules for backing up images from the VistA Imaging network servers and Jukebox unit(s). A copy of the backed up media should be kept off site. Full backups and incremental backups are recommended. For further information, refer to the “Backups” section of Appendix B of the *VistA Imaging System Installation Guide*.

9.8 DICOM-related Backup and Purge

As the software in the VistA Imaging DICOM Gateway is being used, information is created and stored. If left alone, this information would accumulate in an unbounded fashion and would eventually exceed any reasonable storage capability.

A number of entities are purged automatically as the software is being used, based on retention parameters that can be set using the software itself.

The storage of images takes a lot of space, and, as a result, images are typically only stored temporarily on the magnetic disks that are connected to the various workstations and servers. For long-term storage, images are typically copied to a jukebox, and then removed from their temporary cache storage.

9.8.1 Growing entities

The VistA Imaging software creates the following entities:

- Image files (pixel data) temporarily stored on VistA magnetic cache servers
- Image Background Queue (^MAGQUEUE(2006.03, i, ...))
- Modality Worklist Entries (^MAGDWLST(2006.56, i, ...))
- DICOM and PACS Messages (^MAGDHL7(2006.5, i, ...))
- DICOM Failed Images (^MAGD(2006.575, i, ...))
- DICOM Incomplete Images (^MAGD(2006.593, i, ...))
- DICOM Error Log (^MAGD(2006.599, i, ...))
- Error log on DICOM Gateways

9.8.2 Jukebox Archive

9.8.2.1 File Migration

As a part of normal procedure, captured images are copied to long term storage. The process that copies these files observes the following rules:

- Long-term storage media should be non-rewritable optical media.
- Overwrites are not allowed.
- All image-related files (“Full”, “Big”, and “Abstract”) are copied to jukebox.
- Site-specified additional file types are copied to jukebox.(“TXT” is part of the default install setting).
- If a file copy fails, additional attempts are made to copy the file. This is controlled by a site parameter whose default is three attempts.

9.8.2.2 Removing Jukebox Media - Offline Images

The VistA Imaging System is capable of tracking images on platters that have been removed from the jukebox. This is sometimes necessary when all platters in all of slots in the jukebox are full, and a new jukebox has not been purchased or installed. Some sites use this option to archive platters on a first in, first out manner instead of buying additional hardware. By removing a platter, the images on the platter are marked offline. The clinical display software will display an “Archived Image” abstract (thumbnail) for any offline images. If the user clicks on the abstract, a message-box will appear with offline image and associated platter information. If the user chooses to view that image, they can notify an imaging system manager so the platter can be put back into the jukebox. System Managers can also be notified automatically with an email message whenever an offline image is accessed. The OFFLINE IMAGE TRACKERS mail group is installed on the system during the VistA Imaging KIDS installation. System managers that would like to receive notifications should add themselves to the mail group. The procedure below outlines the steps necessary to track offline images.

Note: See the *Storage Utilities User Manual* for the procedure to remove jukebox media.

9.8.2.3 Taking Images Offline

1. Go to DEX Administrator.
2. Click on **View | Reports**, then choose **Media Files**.
3. Click **Next**.
4. Select the media (platter) that will be taken offline. (Multiple select is allowed)
5. Click **Finish**.
6. When the report is available, save it to a file (use Save As) - Be sure to save as type Text (*.txt)

7. Move file to VistA System (ftp; use ASCII mode, not binary mode)
8. Run M option MAG JB OFFLINE (shown below); this procedure will require a FileMan access of “@”.

```

Select Option:  MAG JB OFFLINE

Offline Image Menu

  1  Take images offline (Remove Jukebox Platter)
  2  Put images back online (Insert Jukebox Platter)

OPTION:  1

Enter file to read offline images from: J1_0087.TXT

Here goes nothing...

J1_0087A.....
J1_0087B.....

Done.
    
```

9.8.2.3.1 To Check Which Platters are Offline

```

Select Option:  MAG JB OFFLINE

Offline Image Menu

  1  Take images offline (Remove Jukebox Platter)
  2  Put images back online (Insert Jukebox Platter)
  3  Take images offline (Group platters)
  4  List current offline Jukebox Platter

OPTION:  2

Enter the name of the platter being inserted: ?
Do you want to see a list of all offline platters? y

J1_0085A
J1_0085B
J1_0086A
J1_0086B
J1_0087A
J1_0087B
J1_0143A
J1_0143B
J1_0144A
J1_0144B
    
```

9.8.2.3.2 To Put Images Back Online

```

Offline Image Menu

  1  Take images offline (Remove Jukebox Platter)
  2  Put images back online (Insert Jukebox Platter)

OPTION:  2

Enter the name of the platter being inserted:
J1_0085A.....
.....Done.
    
```

9.8.3 Purge Image Files from VistA Magnetic Cache Manually

The Background Processor Purge software purges image files from the VistA Magnetic Cache, depending upon certain criteria set by the site.

To manually operate this software:

1. From the Windows Start | All Programs menu, select **VistA Imaging Programs | Background Processor | Purge**.

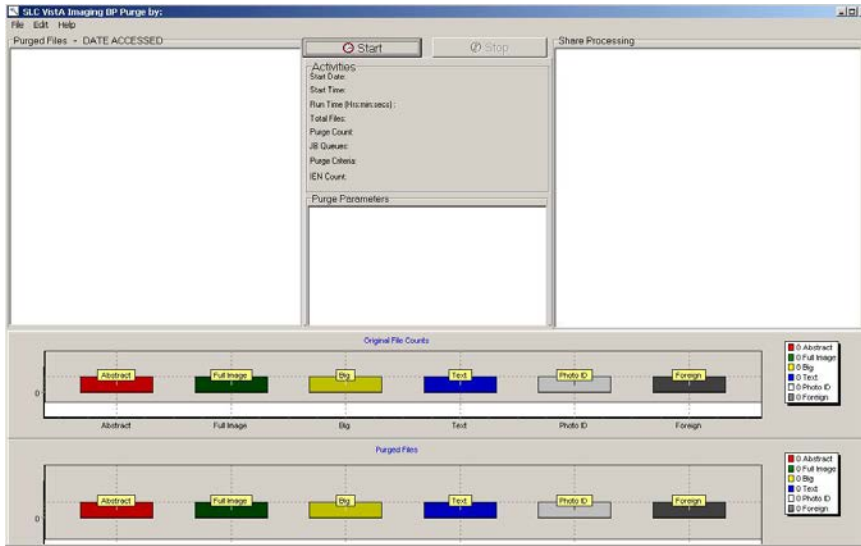

The display box in the upper left quadrant shows the files that will be purged and the date of last access by user application. All listed items are captured in the current Purge.log file. The display is cleared after every 50 items to conserve application memory.

2. To select a subset of image shares for purging, select **Edit | Select Shares**. The Purge Share Select window displays the shares.

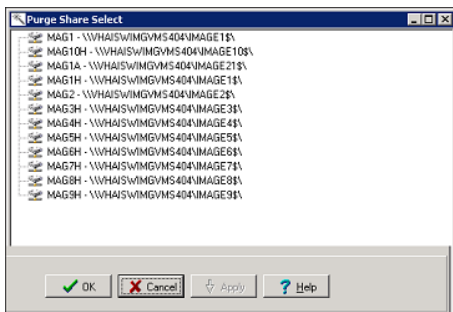

3. Select the share(s) to be purged and click **OK**.
4. Review the Purge parameters and share selection on the Purge window.
5. In the Purge application, click **Start** and **OK** in the confirmation message displayed.

The Activities display (immediately below the start button) shows the time of execution and gives running totals for the VMC files evaluated, the number purged, and the number that were queued to be copied to the Jukebox (JB) because they could not be confirmed on the jukebox.

The Share Processing display lists each online, non-routed, magnetic type share in the NETWORK LOCATION file (#2005.2). These are input values for each step of the purge process and they are appended with a Purged status as they are successfully processed.

The two graphical displays reflect the runtime categorization of image files evaluated and purged as the purge process progresses. Note that the vertical axis units change over the processing period. Also, the units tend to differ between the two graphs.

Steps in the purge process are:

1. The processor initially gets the information from VistA including site parameters governing file aging criteria and online magnetic file server shares.
2. The hierarchical directory structures on each imaging server share are traversed. For each file in each directory, the date of last access is compared against the VistA site file aging criteria for that file type.
3. Files meeting VistA purge criteria are removed from the Imaging magnetic server share, and the IMAGE file (#2005) is updated in the VistA database to indicate the current location of the files on the jukebox.
4. If the image file being evaluated resides on an imaging server share other than the one indicated in the IMAGE file (#2005) in the VistA database, then the file on the unreferenced share is purged regardless of the date of last access as long as the file is present at its referenced location.
5. If there is no corresponding IMAGE file (#2005) entry in the VistA database for this file, the file is purged regardless of age criteria.
6. For sites with a jukebox, if the IMAGE file (#2005) in the VistA database is synchronized with the imaging magnetic cache, but there is no reference to the file's location on the jukebox, then a jukebox copy is queued and the file is left in place on the magnetic server.
7. A site parameter exists for evaluating radiology image files to be held regardless of age if the specific file is related to a radiology package entry with the "NOPURGE" node set.
8. Sites that have no jukebox still must clear space on their magnetic servers. When removing a file from the imaging server, these sites may use the site parameter **No JB Delete Entry** to choose to either:
 - Remove the file server cache references in the IMAGE file (#2005) in the VistA database, or...

- Delete the entire entry in the IMAGE file (#2005) in the VistA database

Note: A monthly verification process may be added to validate the file server references in the IMAGE file (#2005) in the VistA database.

9.8.4 Entities That Are Purged at the Discretion of the Site Supervisor

9.8.4.1 Purge Old Modality Worklist Entries

Old entries may be purged by selecting the option “**Purge old Modality Worklist Entries**” from the “**Text Gateway**” menu.

The subroutine that is called for this menu-option (ENTRY^MAGDDEL1) removes entries in ^MAGDWLST(2006.55 , ...) that were time-stamped more than a certain number of days (the default is the number of days specified in ^MAGDICOM(2006.563 , 1 , "DELETE DAYS")) before the current date.

9.8.4.2 Purge Old DICOM Message Files

Old files and directories may be purged by selecting the option “**Purge old DICOM message files**” from the “**Text Gateway**” menu.

The subroutine that is called for this menu-option (DICOM^MAGDDEL2) removes files and directories that were time-stamped more than a certain number of days (the default is the number of days specified in ^MAGDICOM(2006.563 , 1 , "DELETE DAYS")) before the current date.

Names of directories that may play a role in this context are stored in ^MAGDICOM(2006.563 , 1 , "DATA PATH" , ...).

9.8.4.3 Purge PACS Messages

Old messages may be purged by selecting the option “**Purge old HL7 transaction global nodes**” from the “**Text Gateway**” menu; these messages are stored in global ^MAGDHL7(2006.5).

The subroutine that is called for this menu-option (HL7^MAGDDEL3) removes entries in ^MAGDHL7(2006.5 , ...) that were time-stamped more than the number of days specified in ^MAGDICOM(2006.563 , 1 , "DELETE DAYS") before the current date.

9.8.4.4 Process DICOM Failed Images

Entries are removed from this file by using the Correct RAD-DICOM File Entries [MAGD FIX DICOM FILE] or the Correct Clinical Specialties DICOM File Entries [MAGD FIX CLINSPEC DICOM FILE] menu options. Using this menu will mark the entries as corrected and will be reprocessed by the VistA DICOM Image Gateway. Entries are stored in global ^MAGD(2006.575).

9.8.4.5 Removal of DICOM Incomplete Images

Entries in this file will automatically be removed after an hour's time span; entries are temporary stored in global ^MAGD(2006.593).

9.8.4.6 DICOM Error Log

This file should not be purged. It records incomplete files received and images requested to be deleted from the DICOM FAILED IMAGES file (#2006.575). Entries are stored in global ^MAGD(2006.599).

9.8.4.7 MSM Error log

See the *VistA Imaging DICOM Gateway User Manual* for instructions on how to view and purge entries from the MSM Error Log located in global ^UTILITY(“%ER”,+\$H).

9.9 VIX-related Backups

No special backup processes are needed for the VIX (VistA Image Exchange) service.

- Metadata and images stored on the VIX's dedicated cache are considered transitory copies and are not a part of the patient record. The site from which the data originates is the official custodian of the data, not the VIX.
- The VIX transaction log, which is the primary record of VIX activities, is retained on the server where the VIX is installed for 90 days. A permanent remote backup of the VIX transaction log is also made by the VIX Log Collector service; this is a remote automated service that requires no site configuration or activation.

For more information about the VIX cache and the VIX Log Collector service, refer to the *VIX Administrator's Guide*.

Chapter 10 Callable Routines/Application Programmer Interfaces (APIs)

10.1 Import API

The Import API (Application Programming Interface) was built in VistA Imaging patches 15 and 38 and is used to allow non-imaging VA and commercial vendors to build applications that import images into the VistA database and connect them to the patient record. The Import API was modified in VistA Imaging Patch 108.

The Import API is used by the VA Veteran's ID Card (VIC) and Clinical Procedures applications, as well as commercial applications such as iMed consent and DocManager. The VIC software is used to acquire photographic images of patients. These images are sent to the National Card Management Directory (NCMD). A copy of these photo images are also automatically sent to VistA Imaging through the VistA Imaging Import API.

The Import API also has the following capabilities:

- To check VistA Imaging and verify if a patient has a photo ID on file in VistA Imaging.
- To retrieve a current list of indexing terms.
- To create a new TIU Note stub and attach an image to it.
- To watermark images associated with a Rescinded Advance Directive with the text “Rescinded”.

For more details on the Import API reference the *VistA Imaging System Import API Programmer Guide*. The Import API Programmer Guide can be requested from the VistA Imaging Development Team.

The Import API cannot be used without a written agreement between the VistA Imaging group and the party wishing to use the Import API. All imported images must meet image quality and documentation requirements of VistA Imaging. In addition to the written agreement the VA Policy in section 10.1.1 and FDA Policy in section 10.1.2 must be followed.

10.1.1 VA Policy

VA Policy states the following:

Those components of a national package (routines, data dictionaries, options, protocols, GUI components, etc.) that implement a controlled procedure contain a controlled or strictly defined interface or report data to a database external to the local facility must not be altered except by the VistA Imaging OED staff. A controlled procedure is one that implements requirements that are mandated or governed by law or VA (Department of Veterans Affairs) directive or is subject to governing financial management standards of the Federal Government and VA or that is regulated by oversight groups such as the JCAHO or FDA. A controlled or strictly defined interface is one that adheres to a specific industry standard, will adversely affect a package and/or render the package inoperable if modified or deleted. For national software that is subject to FDA

oversight, only the holder of the premarketing clearance (510(k)) is allowed to modify code for the medical device. The holder of a premarketing clearance is restricted to specifically designated VistA Imaging OED staff that are located at the registered manufacturing site and operating in the designated production environment.

Note: Any party interested in interfacing with the VistA Imaging software will need to contact the VistA Imaging development team to get an integration agreement in place.

10.1.2 FDA Policy

FDA Policy states the following:

The Food and Drug Administration (FDA) classifies this software as a medical device. As such, it may not be changed in any way. Modifications to this software may result in an adulterated medical device under 21CFR820, the use of which is considered to be a violation of US Federal Statutes.

10.2 VistA Imaging Import API

10.2.1 Terms of Use

Note: The Import API, as a part of the VistA Imaging software, is regulated as a medical device. The Import API cannot be used without a written agreement between the VistA Imaging HSD&D group and the party wishing to use the Import API.

To secure an agreement for the use of the Import API, the following criteria must be met:

1. Any products built or interfaced using the VistA Imaging Import API must be tested with VistA Imaging. Testing will be performed by the VistA Imaging team with assistance from field sites and the calling package. This testing must demonstrate that there are no adverse interactions affecting the safety, efficacy or performance of the VistA Imaging software or the devices interfaced to VistA Imaging.
2. Any changes to packages/product(s) using the VistA Imaging Import API must be reported to the VistA Imaging Project Office for review and testing before release. Retesting of VistA Imaging with the product(s) is required with any change.
3. Documentation that imported reports/objects meet VHA, regulatory, and quality requirements must be on file with the Vista Imaging Project Office prior to any clinical use. Sample imported reports/objects shall be provided initially to the VistA Imaging Project Office by the package using the API. Sites installing the VistA Imaging API must comply with all VistA Imaging requirements and are responsible for filing all required documentation with the VistA Imaging Project Office, including image quality and data forms and sample reports/objects from any interfaced device.
4. Additional requirements may apply to non-VA software using the Import API.

Chapter 11 Error Recovery, Troubleshooting, and Testing

11.1 Error Recovery

11.1.1 Server or Disk Drive Failure

When a server or disk drive fails, the VistA Imaging System allows immediate action to be taken so that system operation may continue. The following steps should be taken when a server or drive has failed:

- Use the Network Location Manager menu option on the Background Processor and place the share(s) “OFFLINE”. If these are magnetic drives, their images will be automatically pulled from your jukebox.
- If the Image Network Write Location or PACS Image Write Location field in the IMAGING SITE PARAMETERS file (#2006.1) points to a device that is down, edit it to point to a location that is operational. Use the Edit/Site Parameters menu option on the Background Processor.
- When your server or disk drive has been repaired, edit the Operational Status field (#5) of the NETWORK LOCATION file (#2005.2) to “ONLINE”.
- Run the Verifier software on your magnetic shares to synchronize any pointers changed during the failure, and archive unprocessed files to the jukebox.

11.1.2 Delete Image and Pointers

Images can be deleted using the VistA Imaging Display application. When an image is deleted, the image itself and all "derivative" images (such as abstracts) are deleted from the image servers. Additionally, the IMAGE file (#2005) entry for the image, and any pointers to applications (Laboratory, Medicine, etc.) for that image, are deleted as well. To delete images, a user must have the MAG DELETE security key. For Clinical Display users with this key, there will be a Delete in the main menu of the Image List and Radiology Viewer windows. The Delete option will also be available in pop-up menus for images and abstracts.

The following occurs once an image has been flagged for deletion:

An entry is made in the Background Queue file and will be processed on a first-in-first-out basis by the Background Processor.

The IMAGE AUDIT file (#2005.1) will record the information on the deleted image entry.

An entry will be made in the IMAGE ACCESS LOG file (#2006.95) to indicate that an image was deleted.

The image entry will be deleted from the IMAGE file (#2005) and any pointed to entries will also be updated.

- All DOS files relating to the image will be deleted from the Imaging server(s), but not from the jukebox.

ATTENTION: Caution Must Be Taken when Granting the Image Deletion Key.

Note: Anyone who holds the Image Deletion Key is allowed to delete any image, regardless of who created the image in question.

When images are deleted, a reason code must be entered to note why the image was deleted. Sites can optionally add site-specific reason codes by using the MAG REASON EDIT System Manager Menu option, which is explained in Section 8.2 of this document.

11.1.3 Correcting Image Capture Errors

When an image is captured under the wrong patient, it is **strongly recommended** that you use the following procedure to make the needed correction—provided that the images still reside on the Radiology modality, or a hard copy of the image is still available:

1. Correct the patient information on the modality, then resend the image; **or**, if a hard copy (X-Ray film) of the image is available, digitize the image
2. Review the new images acquired
3. Follow the instructions in the section above to delete the incorrect images

If the above approach is not feasible then contact the Imaging Support staff to assist in correcting the images. The steps they will use are covered below.

Two (2) types of errors can be made during image capture:

- An image is captured that the user did not want to save. This type of error is corrected by the image and pointer deletion procedure described above.
- The user identified the patient incorrectly and therefore saved patient B's images with patient A's text record. Presently, this second type of error must be corrected manually by imaging system manager staff using the following procedure.

11.1.3.1 Delete Incorrect Image Pointers from Incorrect Patient's Record

1. Use the edit option of File Manager to access the image field of the parent package (e.g., radiology, cardiology, laboratory, etc.) for the incorrect patient.
2. Identify and write down the names of the images that were incorrectly placed in this file.
3. Delete these entries.

11.1.3.2 Add Correct Image Pointers to Correct Patient's Record

1. Use the edit option to select the correct patient's report file.
2. Edit the image field and enter the exact same image names that were deleted from the incorrect patient.

11.1.3.3 Verify Correction

Ask the user to examine the image of the correct and incorrect patients, and determine whether the correction was done properly.

11.1.3.4 QA Review Utility

In Clinical Display or Clinical Capture, users who have the MAG SYSTEM or MAG EDIT security keys have access to the QA Review Utility. This utility allows users with the appropriate security key to specify date ranges and perform quality assurance checks on captured images from specified users.

The QA Review Utility also allows the reviewers of the images to change the image indexes by using the Image Index Edit Utility.

11.1.3.5 Image Index Edit Utility

The Image Index Edit Utility is available to users who have the MAG SYSTEM or MAG EDIT security keys. Through this utility, an authorized user can select an image and modify the indexing terms for the image.

11.1.3.6 QA Review Reports

The QA Review Reports are available to users who have the MAG SYSTEM or MAG EDIT security keys. The reports are run for a specified date range and for specific users. The reports give details for users to scan for the date range, status, number of entries and pages, and a percentage representing the total number of images reviewed.

11.2 Troubleshooting / Error Messages

Users may encounter several types of errors as they use the VistA Imaging System. Some of these errors are...

- **Processing errors:** which means that the VistA Imaging System failed to complete a processing task.
- **Data errors:** which means that the VistA Imaging System attempted to use data that was incomplete or formatted incorrectly.
- **Command errors:** which means that users and other programs that interact with Imaging issued commands that conflicted with other commands or with the VistA Imaging System processing state.

A table of error messages, descriptions and causes or solutions is provided in Appendix A of this document and in the *VistA Imaging Error Message Guide*.

11.3 Test Software Available for Troubleshooting

11.3.1 Introduction

When setting up a workstation, it is often necessary to use software to test isolated workstation functions. A number of executables are available for testing:

- Network connectivity
- Connectivity to the Kernel RPC Broker
- Ability to display images
- Connectivity to image servers
- Network timing tests

These executables are described in the following sections.

11.3.2 PING, TRACERT

The PING and TRACERT commands are available in the DOS directory on the workstations. Using these commands can help determine if the IP address supplied in the HOSTS or LMHOST file is reachable, or if a possible routing problem exists. The local PC support person in IRM can assist with the usage of these commands and the local network IP addressing scheme.

11.3.3 RPCTEST.EXE

The RPCTEST.EXE file is located in the Program Files\VISTA\BROKER directory. This file can be used to test the Broker Client Manager connection to the VistA servers. Once this file is executed, the VistA Access/Verify Code Window should display. If it does not, one or a combination of the following could be happening:

- The TCP Listener is not running on the VistA hospital system.
- An invalid IP address or listening port number was configured during the Broker Client Manager software installation on the workstation.

Note: Please review the Kernel RPC documentation on the usage of this executable file and installation of the RPC Client Manager software.

11.3.4 VistA Imaging Capture, Test Mode

The VistA Imaging Capture software has a Test mode that allows testing of input devices (scanners, video capture boards, etc.). The Test mode features...

- Testing of the capture functions without a connection to the VistA servers.
- No requirement to identify patients.

In addition, the image test file will not be saved. This mode is helpful when interfacing and testing new equipment.

To set the application to test mode, select **Test Mode** from the **Configuration | Configuration Settings | All Settings** menu.

Note: See the Capture online help for additional information.

Chapter 12 External Relations

12.1 HL7 Messages

The Text gateway processes the following HL7 message types to construct and maintain the Modality Worklist Database:

ADT	Admission, Discharge, Transfer
SCH	Patient Appointment and Scheduling Segment
MFN	Master File Notification
ORM	Order Message
ORU	Observational Result – Unsolicited

12.2 HL7 Application Parameters

VistA Imaging includes the following HL7 application parameters:

- MAG COMRCL PACS

This application name represents the destination for HL7 messages, and will appear in field 5 of the Message Header segment (MSH-5) of the HL7 message generated by VistA. The value in its FACILITY NAME Field will appear in MSH-6.

- MAG VISTA IMGNG

This application name represents the origin for HL7 messages, and will appear in MSH-3. The value in its FACILITY NAME Field will appear in MSH-4.

These entries are added to the HL7 APPLICATION PARAMETER File (#771) during installation.

NAME: MAG COMRCL PACS	ACTIVE/INACTIVE: ACTIVE
FACILITY NAME: CPACS FACILITY	
NAME: MAG VISTA IMGNG	ACTIVE/INACTIVE: ACTIVE
FACILITY NAME: VA-WOIFO	

You can change the value of the NAME or FACILITY NAME attributes through VistA option HL EDIT APPL PARAM.

12.3 HL7 Logical Link

VistA Imaging includes the HL7 logical link MAG CPACS .

This entry will be added to the HL7 LOGICAL LINK File (#870) during installation:

NODE: MAG CPACS	LLP TYPE: TCP
QUEUE SIZE: 10	READ TIMEOUT: 90
ACK TIMEOUT: 90	TCP/IP SERVICE TYPE: CLIENT (SENDER)

This logical link contains information about the commercial PACS destination, including its TCP/IP parameters (IP address and port number). The VistA HL7 package uses the IP address and port number to route messages to their destination over the network. You can change the value of the IP address and port number using VistA option HL EDIT LOGICAL LINKS.

12.4 Broker Calls

12.4.1 Imaging Broker Calls

All VistA Imaging remote procedure calls are documented in the REMOTE PROCEDURE file (#8994) and can be viewed using FileMan Print or Inquire menu options. VistA Imaging remote procedures use the MAG namespace.

```
FileMan 22
Select OPTION: PRINT FILE ENTRIES
OUTPUT FROM WHAT FILE: REMOTE PROCEDURE
SORT BY: NAME//
START WITH NAME: FIRST// MAG
GO TO NAME: LAST// MAGZ
  WITHIN NAME, SORT BY:
FIRST PRINT FIELD:
FIRST PRINT FIELD: [CAPTIONED]
Include COMPUTED fields: (N/Y/R/B): NO// - No record number (IEN), no Computed Fields
Heading (S/C): REMOTE PROCEDURE LIST Replace
START AT PAGE: 1//
DEVICE:
```

12.4.2 DICOM RPC Broker Calls

The VistA Imaging DICOM Gateway software uses the following Kernel RPC Broker calls.

- The column **View-only Access** contains the RPCs accessible to an end-user who has the MAG DICOM GATEWAY VIEW menu assigned.
- The column **Full Access** contains the RPCs that are available when a user has the MAG DICOM GATEWAY FULL menu assigned.
- The column **Query/Retrieve** contains RPCs that are accessible to an end-user who has the MAG DICOM QUERY RETRIEVE menu assigned.

View-only Access	Full Access	Query/Retrieve	Remote Procedure
Yes	Yes	Yes	MAG CFIND QUERY
Yes	Yes	-	MAG DICOM ADD CAMERA EQUIP RM
Yes	Yes	-	MAG DICOM AUDIT COUNT
-	Yes	-	MAG DICOM AUDIT PURGE
Yes	Yes	-	MAG DICOM AUDIT RANGE
Yes	Yes	-	MAG DICOM CHANGE HL7 POINTER
Yes	Yes	Yes	MAG DICOM CHECK AE TITLE
Yes	Yes	-	MAG DICOM CORRECT VALIDATE
Yes	Yes	-	MAG DICOM ET PHONE HOME
Yes	Yes	-	MAG DICOM FILEMAN GET
Yes	Yes	-	MAG DICOM FIND LOCATION
Yes	Yes	-	MAG DICOM GET BASIC IMAGE
Yes	Yes	-	MAG DICOM GET DFN
Yes	Yes	-	MAG DICOM GET DOMAIN
Yes	Yes	Yes	MAG DICOM GET GATEWAY INFO
Yes	Yes	-	MAG DICOM GET HIGHEST HL7
Yes	Yes	-	MAG DICOM GET HOSP LOCATION
Yes	Yes	-	MAG DICOM GET IMAGE GROUP
Yes	Yes	-	MAG DICOM GET IMAGING TYPES
Yes	Yes	-	MAG DICOM GET MACHINE ID
-	Yes	-	MAG DICOM GET NEXT QUEUE ENTRY
Yes	Yes	-	MAG DICOM GET PATIENT
Yes	Yes	-	MAG DICOM GET PLACE
Yes	Yes	-	MAG DICOM GET RAD CAMERA
Yes	Yes	-	MAG DICOM GET RAD CPT MOD
Yes	Yes	-	MAG DICOM GET DX CODE
Yes	Yes	-	MAG DICOM GET FILM
Yes	Yes	-	MAG DICOM GET INFO BY ACN
Yes	Yes	-	MAG DICOM GET RAD ORDERS
Yes	Yes	-	MAG DICOM GET RAD PERSON
Yes	Yes	-	MAG DICOM GET RAD RPT INFO
Yes	Yes	-	MAG DICOM GET SERVICE INFO

View-only Access	Full Access	Query/ Retrieve	Remote Procedure
Yes	Yes	-	MAG DICOM GET UID ROOT
Yes	Yes	-	MAG DICOM GET UID TABLE
Yes	Yes	-	MAG DICOM GET USERNAME
Yes	Yes	-	MAG GET DICOM XMIT ORIGIN
Yes	Yes	-	MAG DICOM GET VERSION
-	Yes	-	MAG DICOM HL7 POINTER ACTION
Yes	Yes	-	MAG DICOM IMAGE AUDIT GET
-	Yes	-	MAG DICOM IMAGE PROCESSING
Yes	Yes	-	MAG DICOM IMPORTER CHECK UIDS
Yes	Yes	-	MAG DICOM IMPORTER DELETE
Yes	Yes	-	MAG DICOM IMPORTER LOOKUP
Yes	Yes	-	MAG DICOM INCORRECT IMAGE CT
Yes	Yes	-	MAG DICOM LIST GLOBAL VARIABLE
Yes	Yes	-	MAG DICOM LOOKUP RAD STUDY
Yes	Yes	-	MAG DICOM LOOKUP STUDY
-	Yes	-	MAG DICOM NETWORK STATUS
Yes	Yes	-	MAG DICOM PACS CUTOFF DATE
Yes	Yes	-	MAG DICOM PACS MINIMUM SPACE
-	Yes	-	MAG DICOM PURGE HL7
-	Yes	-	MAG DICOM QUEUE IMAGE
-	Yes	-	MAG DICOM QUEUE INIT
Yes	Yes	-	MAG DICOM RADIOLOGY MODIFIERS
Yes	Yes	-	MAG DICOM RADIOLOGY PROCEDURES
-	Yes	-	MAG DICOM ROUTE EVAL LOG
-	Yes	-	MAG DICOM ROUTE EVAL START
-	Yes	-	MAG DICOM ROUTE EVAL STOP
-	Yes	-	MAG DICOM ROUTE GET PURGE
-	Yes	-	MAG DICOM ROUTE GET TRANS ID
Yes	Yes	-	MAG DICOM ROUTE LIST DESTI
-	Yes	-	MAG DICOM ROUTE LOCK TRANSMIT
-	Yes	-	MAG DICOM ROUTE LOG XMIT
-	Yes	-	MAG DICOM ROUTE NEXT FILE
-	Yes	-	MAG DICOM ROUTE PURGE DONE
-	Yes	-	MAG DICOM ROUTE REMOVE OBSO
-	Yes	-	MAG DICOM ROUTE REQUEUE
-	Yes	-	MAG DICOM ROUTE STATUS
Yes	Yes	-	MAG DICOM ROUTE TRANSACT STS
Yes	Yes	-	MAG DICOM ROUTE VALID DEST
-	Yes	-	MAG DICOM SET PACS PARAMS
Yes	Yes	Yes	MAG DICOM STORE GATEWAY INFO
Yes	Yes	-	MAG DICOM TEXT AUDIT GET
-	Yes	-	MAG DICOM TEXT PROCESSING
-	Yes	-	MAG DICOM UPDATE GATEWAY NAME
-	Yes	-	MAG DICOM UPDATE SCU LIST
Yes	Yes	-	MAG DICOM VALID LOCATIONS

View-only Access	Full Access	Query/ Retrieve	Remote Procedure
Yes	Yes	Yes	MAG DICOM VISTA AE TITLE
Yes	Yes	-	MAG DICOM WORKSTATION VERSION
Yes	Yes	Yes	MAG IMAGE CURRENT INFO
Yes	Yes	-	MAG NEW SOP INSTANCE UID
Yes	Yes	-	MAG RAD GET NEXT RPT BY DATE
Yes	Yes	-	MAG RAD GET NEXT RPT BY PT
Yes	Yes	Yes	MAG STUDY UID QUERY
Yes	Yes	-	MAG VISTA CHECKSUMS
Yes	Yes	-	MAGG VERIFY ESIG
Yes	Yes	-	SC PATIENT LOOKUP
Yes	Yes	-	XUS DIVISION GET
Yes	Yes	-	XUS DIVISION SET
Yes	Yes	-	XUS INTRO MSG

12.5 Windows Messaging

In order to communicate with CPRS, windows messages are exchanged on the workstation. The VistA Imaging System must be launched from the CPRS menu option to enable the exchange of these messages.

If CCOW is enabled, VistA Imaging Clinical Display will synchronize patient and user context with other CCOW applications (such as CPRS) using CCOW. If CCOW is unavailable, VistA Imaging Clinical Display will continue to synchronize with CPRS when launched from CPRS using Windows messages.

12.6 Integration Control Registrations

Integration Control Registrations (ICRs) describe how one VistA application uses routines that belong to another VistA application.

To display the ICRs that cover non-Imaging routines used by Imaging, perform the steps below.

1. Sign on to the FORUM system.
2. Select the DBA menu.
3. Select the INTEGRATION CONTROL REGISTRATIONS [IAs] menu.
4. Select the Subscriber Package Menu [SUBS].
5. Choose the “Print ACTIVE by Subscribing Package” option.
6. Enter “IMAGING” at the “START WITH SUBSCRIBING PACKAGE: FIRST//” prompt.
7. Enter “IMAGINGZ” at the “GO TO SUBSCRIBING PACKAGE: LAST//” prompt.
8. Select the device for printing.

To display the ICRs that cover Imaging routines used by other applications, perform the steps below.

1. Sign on to the FORUM system.
2. Select the DBA menu.
3. Select the INTEGRATION CONTROL REGISTRATIONS [IAs] menu.
4. Select the Custodial Package Menu [CUST].
5. Choose the “ACTIVE ICRs by Custodial Package” option.
6. Enter “IMAGING” for the package prompt.
7. Select the device for printing.

12.7 CCOW Communication

When available, the VistA Imaging Clinical Display client uses CCOW to synchronize patient and user context with other applications such as CPRS.

The TeleReader application requires CCOW to synchronize patient and user context with other applications such as CPRS and VistA Imaging Display. TeleReader cannot work if CCOW is unavailable, TeleReader will close if CCOW is not functioning properly.

12.8 Mailman Messaging

This section describes the types of MailMan messages that are sent to a site’s MAG SERVER mail group.

The MAG SERVER mail group is established when VistA Imaging is installed. MAG SERVER initially contains the addresses of the person that installed VistA Imaging and of the VistA Imaging development team.

- Typical members of this group should be key IRM support staff, radiology managers, and/or ADPACS.
- Text pagers can be added to the MAG SERVER mail group as a “Remote Member”, provided that the domain portion of the remote mail member address is defined in the DOMAIN file (#4.2).

Note: The “[G.IMAGING DEVELOPMENT TEAM@FORUM.VA.GOV](mailto:G.IMAGING_DEVELOPMENT_TEAM@FORUM.VA.GOV)” is a required member of this group.

The members of the MAG SERVER mail group (aka the Local Imaging Mail Group) can be edited as described in Chapter 6 of the Background Processor User Manual.

12.8.1 “Image Cache Critically Low” Messages

The Image Cache Critically Low message is generated automatically when the Background Processor is unable to update the network write location within the VistA Magnetic Cache. This happens when the low level mark has been reached and the current location has only 5% (default value) of its capacity available at the time this message is generated.

The following is a sample Image Cache Critically Low Message:

```

Subj: Image Cache Critically Low at OAKMONT.VA.GOV [#118174]
18 Sep 2000 15:22:38 -0600 (CST) 12 lines
From: <IMAGUSER.ONE@SITE1.VA.GOV> In 'CRITICAL' basket. Page 1
-----
SITE: SITE1.VA.GOV
DATE: SEP 18, 2000@15:22:38 CST
SENDER: Imaging Background Processor
The 3 Imaging cache servers will require operator intervention to ensure
continued availability. The following MAG SERVER members are being
notified:
IMAGUSER,TWO
IMAGUSER,THREE
G.IMAGING DEVELOPMENT TEAM@FOR
The next notifications will occur in: 6 hours.

```

This mechanism ensures that the remaining cache locations can be manually referenced during the free space recovery process (BP Purge) that the VistA Imaging System Manager MUST initiate. It is advised that while the purge is running the Auto Write Location update process be turned off, and that the Network Write Location and the PACS Write Location be manually updated to different locations. For more information, see Chapter 6 in the *Background Processor User Manual*.

12.8.2 “Image Site Usage” Messages

When VistA Imaging is installed, a process used to generate monthly Image Site Usage messages is established. Image Site Usage messages contain information about VistA Imaging statistics (images displayed, images captured, etc.) and the software and patch versions installed. The information in these messages is used for the VistA Imaging VISN (Veterans Integrated Service Network) Performance Monitor Report.

Image Site Usage messages are automatically generated at 4:01 AM (VistA System time) on the first day of each month, and will be sent to the MAG SERVER mail group. They can also be generated on demand as described on the next page.

A sample monthly Image Site Usage message is shown below.

```

Subj: Monthly Image Site Usage: DEM0.SITE(Apr 2005)[#19] 01 May 05 04:00 49 lines
From: IMAGUSER,ONE In 'IN' basket. Page 1
-----
SITE: IMGDEM01.MED.VA.GOV
Reporting Period: Apr 01, 2005 - Apr 30, 2005
DATE: MAY 01, 2005@04:00:39 EST
DOMAIN: IMGDEM01.MED.VA.GOV
2005 ENTRIES: 1942
2006.81 ENTRIES: 94
WS DIS VERS: 3.0.0.1^1
WS DIS VERS: 3.0.2.3^4

```

```

WS DIS VERS: 3.0.7.10^8
WS DIS VERS: 3.0.7.10^Microsoft Windows 2000 .5.0.2195^1
WS DIS VERS: 3.0.7.7^1
WS DIS VERS: 3.0.8.13^1
WS DIS VERS: 3.0.8.20^1
WS CAP VERS: 3.0.0.1^1
WS CAP VERS: 3.0.7.10^1
WS CAP VERS: 3.0.7.10^Microsoft Windows 2000 .5.0.2195^1
WS VR VERS: 3.0.38^2
WS VR VERS: 3.0.38^Win NT.4.0.1381^1
WS VR VERS: 3.0.40^1
WS VR VERS: UNK^1
VistaRad Version: 3.0T20
DICOM Error Log:0
DICOM FAILED IMAGES:83
Queue File count: 19
Unprocessed Queue entries: 19
28 day Image Workstation Sessions: 3162
28 day Image Workstation Patients: 4658
28 day Image Workstation Images: 14093
28 day Image Workstation Captures: 923
28 day VistaRad WS Display:
28 day VistaRad WS Interpretations:
28 day average daily routed images: 0
BP VERS NUM DATE: <xxx>
Vista Image Version/Build: 3.0^19^3030414
DICOM Gateway Version: 3.0;IMAGING;*1,7,8,3**;30-August-2002^1
Image file namespace(s): DM
From, FileMan Date="3040201", D0="0".
Until, FileMan Date="3040228", D0="7477".
RESOLUTION: SCR_OK^1024^768^24^PC^2
RESOLUTION: SCR_OK^1024^768^32^PC^9
RESOLUTION: SCR_OK^1152^864^32^PC^3
RESOLUTION: SCR_OK^1280^1024^32^PC^21
RESOLUTION: SCR_OK^1400^1050^32^PC^2
...
...
DICOM CAPTURE: CR^12^Computed Radiography^1
DICOM CAPTURE: CT^500^Computed Tomography
IMPORT API: <xxx>
IMPORT API: <xxx>
CLIN CAPTURE: XRAY^151
OTHER CONSENTS: PRE-ANESTHESIA CONSENT^1
CONSENT FORMS: 0
Image file group parents: 150
Image file objects: 1792
Image file deletes: 12
Document Images (TIF): 123
Document Groups (TIF): 12
Unique Image patients captured: 55
Unique Image patients display: 33
Unique Image patients All: 56
ADVANCE DIRECTIVE SCANNED ADMINISTRATIVE CLOSURE: 0
ADVANCE DIRECTIVE UNSCANNED MANUAL CLOSURE: 25
ADVANCE DIRECTIVE - UMC - ADVANCED DIRECTIVE: 2
ADVANCE DIRECTIVE - UMC - ADVANCE DIRECTIVE FORM: 23
ADVANCE DIRECTIVE SCANNED MANUAL CLOSURE: 8
ADVANCE DIRECTIVE SCANNED MANUAL CLOSURE: 6
ADVANCE DIRECTIVE - SMC - ADVANCE DIRECTIVE: 8
IMAGING PACKAGE INSTALLATION HX: 13^IMAGING^3.0P1^MAY 17,2002^TESTER,ONE
IMAGING PACKAGE INSTALLATION HX: 14^IMAGING^3.0P7^AUG 09,2002^TESTER,ONE
IMAGING PACKAGE INSTALLATION HX: 15^IMAGING^3.0P19^APR 14,2003^TESTER,ONE
IMAGING PACKAGE INSTALLATION HX: 17^MAGJ RADIOLOGY^P3.0T10^JUL 30,2000^TESTER,ONE
IMAGING PACKAGE INSTALLATION HX: 18^MAGJ RADIOLOGY^P3.0T15^JUL 19,2001^TESTER,ONE
IMAGING PACKAGE INSTALLATION HX: 19^MAGJ RADIOLOGY^P3.0T17^JAN 04,2002^TESTER,ONE
IMAGING PACKAGE INSTALLATION HX: 20^MAGJ RADIOLOGY^P3.0T18^JAN 04,2002^TESTER,ONE
IMAGING PACKAGE INSTALLATION HX: 21^MAGJ RADIOLOGY^P3.0T19^FEB 07,2002^TESTER,ONE
IMAGING PACKAGE INSTALLATION HX: 22^MAGJ RADIOLOGY^P3.0T20^FEB 27,2002^TESTER,ONE
IMAGING PACKAGE INSTALLATION HX: 23^MAGJ RADIOLOGY^P3.0T5^AUG 07, 1999^TESTER,ONE
IMAGING PACKAGE INSTALLATION HX: 24^MAGJ RADIOLOGY^P3.0T6^AUG 07, 1999^TESTER,ONE
IMAGING PACKAGE INSTALLATION HX: 25^MAGJ RADIOLOGY^P3.0T9^JUL 30, 2000^TESTER,ONE
LOCAL NETWORK LOCATIONS: 0^NETWORK LOCATION^PHYSICAL REFERENCE^TOTAL SPACE^SPACE
USED^FREE SPACE^OPERATIONAL STATUS^STORAGE TYPE^HASH
LOCAL NETWORK LOCATIONS: 1^LOCAL^C:\IMAGE\^^^On-Line^MAGNETIC^YES
LOCAL NETWORK LOCATIONS: 2^MAG1^\IMGQADB\IMAGE1$\^9080608^^10160^On-Line^MAGNETIC^

```

```
LOCAL NETWORK LOCATIONS: 3^MAG1H^\imgqadb\image1$\^9080608^^1016440^On-
Line^MAGNETIC^YES
...
```

The following sections explain how an Ad Hoc (on demand) version of an Image Site Usage message can be generated, describe the contents of a typical Site Usage message, and outline how automatic Image Site Usage message generation can be disabled.

12.8.2.1 Ad Hoc Image Site Usage Messages

To generate an on-demand version of the Imaging Site Usage message, perform the following steps.

1. Access the Imaging System Manager Menu [MAG SYS MENU] and run the Ad Hoc Enterprise Site Report option.

```
Select OPTION NAME: MAG SYS MENU      Imaging System Manager Menu

  IX      Image Index Conversion Menu ...
  LS      Edit Network Location STATUS          **
          Ad hoc Enterprise Site Report
          Delete Image Group
          Imaging Database Integrity Checker Menu ... **
          Imaging Site Reports

Select OPTION NAME: AD HOC           Ad hoc Enterprise Site Report
```

2. At the next two prompts, enter the date range that you want the report to cover. The prompts will default to the previous month.

```
Enter starting Date: APR 01 2003// <ENTER> (APR 01, 2003)
Enter ending Date: APR 30 2003// <ENTER> (APR 30, 2003)

Creating ad-hoc report over the period 1-Apr-2003 until 30-Apr-2003.

  IX      Image Index Conversion Menu ...
  LS      Edit Network Location STATUS          **
          Ad hoc Enterprise Site Report
          Delete Image Group
          Imaging Database Integrity Checker Menu ... **
          Imaging Site Reports

Select OPTION NAME:
```

3. After the report is generated, it will be sent in a MailMan message to the MAG SERVER mail group. The subject of the message will be “Ad Hoc Image Site Usage.”

12.8.2.2 Contents of an Image Site Usage Message

The contents of the Image Site Usage message are described in the following table. Note that some entries in the message are dependent on the Imaging components and patches installed—for example, entries specific to VistARad workstations will not be present at sites that do not use VistARad.

Entry Name	Description
Site	The name of the medical center for which the message was generated.
Reporting Period	The time period covered by the report. Note that for Ad-Hoc reports, the date range specified by the user is indicated (which may be greater than the date range of the available data).
Date	The date the message was generated.
Domain	The VistA mail domain name where the message was generated.
2005 Entries	The number of entries in the IMAGE file (#2005), based on the value in the IMAGE File header.
2006.81 Entries	The total number of Clinical Display and Clinical Capture workstations, as indicated in the IMAGING WINDOWS WORKSTATIONS file (#2006.81).
Production Account	The value is equal to "1" if the message is generated from the site's production database environment.
WS DIS VERS	<p>An array showing installations of the VistA Imaging Clinical Display software. The array contains the following values:</p> <p style="text-align: center;">VERSION ^ OPERATING_SYSTEM ^ #INSTALLED</p> <p>An entry will be generated for each unique combination of VERSION and OPERATING_SYSTEM, for all Display workstations that have been accessed in the last 180 days.</p>
WS CAP VERS	<p>An array showing installations of the VistA Imaging Clinical Capture software. The array contains the following values:</p> <p style="text-align: center;">VERSION ^ OPERATING_SYSTEM ^ #INSTALLED</p> <p>An entry will be generated for each unique combination of VERSION and OPERATING_SYSTEM, for all Capture workstations that have been accessed in the last 180 days.</p>
WS VR VERS	<p>An array showing installations of the VistARad workstation software. The array contains the following values:</p> <p style="text-align: center;">VERSION ^ OPERATING_SYSTEM ^ #INSTALLED</p> <p>An entry will be generated for each unique combination of VERSION and OPERATING_SYSTEM, for all VistARad workstation that have been accessed in the last 180 days.</p>
VistARad Version	The most recently installed version of VistARad. For the installation history of all instances of VistARad, refer to the "Imaging Package Installation HX" field.

Entry Name	Description
DICOM Error Log	The total number of unresolved DICOM errors present in the DICOM Error Log (#2006.599) on the date the report was generated.
DICOM Failed Images	The total number of entries in the DICOM FAILED IMAGES file (#2006.575) on the date the report was generated.
Queue File Count	The total number of entries in the IMAGE BACKGROUND QUEUE file (#2006.03), including failed entries that will not be processed without user intervention. (Successfully processed entries are deleted from the file.)
Unprocessed Queue Entries	The total number of unprocessed entries currently in the IMAGE BACKGROUND QUEUE file (#2006.03).
<i>N</i> day Image Workstation Sessions	The number of login sessions that occurred on all workstations (Display, Capture, and VistARad) for the period of the report.
<i>N</i> day Image Workstation Patients	The number of patient lookups performed on Display and Capture workstations for the period of the report.
<i>N</i> day Image Workstation Images	The total number of images accessed from all Clinical Display and Capture workstations for the period of the report.
<i>N</i> day Image Workstation Captures	The number of images acquired using Capture workstations for the period of the report.
<i>N</i> day VistARad WS Display	<p>An array containing information for studies displayed on all VistARad workstations for the period of the report. The array contains the following values:</p> <p>STUDIES ^ IMAGES ^ PATIENTS ^ RAD/NONRAD ^ ROUTED/LOCAL ^ STUDIES_PER_MODALITY</p> <p>STUDIES: The number of studies displayed.</p> <p>IMAGES: The number of images displayed.</p> <p>PATIENTS: The number of patient records accessed.</p> <p>RAD/NONRAD: The number of studies displayed by radiologists and non-radiologists, respectively.</p> <p>ROUTED/LOCAL: The number of routed and non-routed exams displayed, respectively.</p> <p>STUDIES_PER_MODALITY: An array of modalities and the numbers of displayed studies for each modality.</p>

Entry Name	Description
N day VistARad WS Interpretations	<p>An array containing information for studies interpreted using all VistARad workstations for the period of the report. The array contains the following values:</p> <p>STUDIES ^ IMAGES ^ PATIENTS ^ RAD/NONRAD ^ ROUTED/LOCAL ^ STUDIES_PER_MODALITY</p> <p>STUDIES: The number of studies interpreted.</p> <p>IMAGES: The number of images interpreted.</p> <p>PATIENTS: The number of patient records accessed.</p> <p>RAD/NONRAD: The number of studies interpreted by radiologists and non-radiologists, respectively (the value for non-radiologist interpretations should always be 0).</p> <p>ROUTED/LOCAL: The number of routed and non-routed exams interpreted, respectively.</p> <p>STUDIES_PER_MODALITY: An array of modalities and the numbers of interpreted studies for each modality.</p>
N day average daily routed images	The average number of studies routed per day.
BP Vers. Num. Date	<p>An array showing installations of the Background Processor client software. The array contains the following values:</p> <p>CLIENT_VERSION ^ OPERATING_SYSTEM ^ #INSTALLED ^ BUILD_DATE</p> <p>An entry will be generated for each unique combination of VERSION and OPERATING_SYSTEM for all Background Processor workstations.</p>
VistA Image Version/Build	<p>The most recent VistA Imaging KIDS installation, presented in an array with the following values:</p> <p>RELEASE ^ PATCH ^ INSTALL_DATE</p>
DICOM Gateway Version	<p>An array showing installations of the DICOM Gateway workstation software. The array is based on the contents of the DICOM WORKSTATION file (#2006.83), and contains the following values:</p> <p>VERSION;PACKAGE_NAME;PATCHES;BUILD_DATE ^ #_INSTALLED</p>
Image file namespace(s)	The unique 1-, 2-, or 3-character filename prefix used for images stored at this site. If multiple prefixes are used by a site, each prefix will be shown.

Entry Name	Description
From FileMan Date Until FileMan Date	Fields that provide information which may be helpful to support staff when the report contains unexpected values.
Resolution	<p>Reports the number of workstations and the resolutions being used by their monitors.</p> <p>CLASS ^ COLUMNS ^ ROWS ^ BITS ^ TYPE ^ COUNT</p> <p>CLASS: Indicates if the monitors in this group have acceptable or unacceptable display capabilities.</p> <p>COLUMNS^ROWS: The number or vertical and horizontal pixels.</p> <p>BITS: The bit-depth.</p> <p>TYPE : The workstation type (PC or Thin Client (TC)).</p> <p>COUNT: The number of workstations.</p>
DICOM Capture	<p>An array showing the modality and number of images acquired by all DICOM Image Gateways during the reporting period. The array contains the following values.</p> <p>MODALITY_ABBR ^ IMAGES_ACQUIRED ^ MODALITY_NAME ^ GROUPS_ACQUIRED</p> <p>An entry will be generated for each modality that images are acquired from.</p>
Import API	<p>Provides a count of images and image groups that were acquired by the Import API, broken down by sending application (origin).</p> <p>SOURCE_APP ^ #IMAGES ^ #GROUPS</p> <p>Only present for sites that use the Import API.</p>
Clin Capture	<p>An array showing the PROCEDURE Field (#2005,6) and number of images acquired by all Capture workstations during the reporting period. The array contains the following values.</p> <p>PROC_FIELD ^ IMAGES_CAPTURED</p> <p>An entry will be generated for each procedure field entry that images are captured for.</p>
Other Consents	<p>An array showing the number of captured consent forms , based on the contents of the SHORT DESCRIPTION field (#2005,10) for the report period.</p> <p>SHORT_DESC_FIELD ^ IMAGES</p> <p>An entry will be generated for each SHORT DESCRIPTION field value containing the word “consent”. (For example, CONSENT and INFORMED CONSENT would be shown in two different entries).</p>
Consent Forms	The number of consent forms captured for the report period.
Image file group parents	The number of image group parent entries added to the IMAGE file (#2005) during the report period.
Image file objects	The number of entries (excluding group parent entries) added to the IMAGE file (#2005) during the report period.

Entry Name	Description
Image file deletes	The number of entries deleted from the IMAGE file (#2005) during the report period. Note that this value indicates only those entries that were both added AND deleted within the report period.
Document Images (TIF)	The number of scanned document images acquired during the reporting period.
Document Groups (TIF)	The number of scanned document groups acquired during the reporting period.
Total Image Objects for Place	The count for entire institutional database
Total Group Parents for Place	The count for entire institutional database
Total Image Entry Deletes for Place	The count for entire institutional database
Unique Image Patients Captured	The number of individual patients that had new images added (using VistA Imaging) during the report period.
Unique Image Patients Display	The number of individual patients that had images displayed using Clinical Display or VistARad during the report period.
Unique Image Patients All	The total number of individual patients that had images displayed or captured during the report period.
Total Non-Verified Images for Place	Count for reporting period
Total Verified Images for Place	Count for reporting period
Total Duplicate Images for Place	Count for reporting period
TLR SPECIALITY	TeleReader reporting period count
TLR PROCEDURE	TeleReader reporting period count
TLR LOCAL STUDIES	TeleReader reporting period count
TLR REMOTE STUDIES	TeleReader reporting period count
TLR LOCAL IMAGES	TeleReader reporting period count
TLR REMOTE IMAGES	TeleReader reporting period count
TLR LOCAL READING TIME	TeleReader reporting period count
TLR REMOTE READING TIME	TeleReader reporting period count
TLR RESULTED LOCALLY BY TELEREADER	TeleReader reporting period count
TLR RESULTED LOCALLY BY CPRS	TeleReader reporting period count

Entry Name	Description
TLR RESULTED REMOTELY BY TELEREADER	TeleReader reporting period count
TLR RESULTED REMOTELY BY CPRS	TeleReader reporting period count
TLR LOCAL ACQUISITION TIME	TeleReader reporting period count
TLR REMOTE ACQUISITION TIME	TeleReader reporting period count
ASSOCIATED INSTITUTIONS	TeleReader reporting period count
ACCESS TYPE(app name)	TeleReader reporting period count
Advance Directive Scanned Administrative Closure	<for future use>
Advance Directive Unscanned Manual Closure	The number of signed Advance Directive notes that do not have attached scanned documents.
Advance Directive – UNC - <i>title</i>	The number of Advance Directive notes without attached scanned documents, broken down by TIU note title.
Advance Directive Scanned Manual Closure	The number of signed Advance Directive notes that have attached scanned documents.
Advance Directive – SMC - <i>title</i>	The number of Advance Directive notes with attached scanned documents, broken down by TIU note title.
Imaging Package Installation HX	<p>An array showing the installation history of the VistA Imaging KIDS software. The array is based on the PACKAGE file (#9.4), and contains the following values:</p> <p>SEQ_NUM ^ PACKAGE ^ VERSION ^ DATE ^ INSTALLER</p> <p>SEQ_NUM: Installation sequence.</p> <p>PACKAGE: The package being installed. "Imaging" is used for the VistA Imaging KIDS packages; "MAGJ Radiology" refers to pre-3.0 Imaging installations of the VistARad software.</p> <p>VERSION: The version number of the software.</p> <p>DATE: The date the software was installed.</p> <p>INSTALLER: The user account used to install the software.</p> <p>Entries will be generated both for current and pre-existing software versions.</p>

Entry Name	Description
Local Network Locations	<p>Each line shows information about a NETWORK LOCATION file (#2005.2) entry defined at the site. The first line (the one that begins with 0) is a header line that show the names of the values reported in subsequent lines. Subsequent lines show 2005.2 entries that:</p> <ul style="list-style-type: none"> • Have a Storage Type other than 'Export' or 'Diagram' • Are on-line • Are not 'Routing' shares.

12.8.2.3 MAGREPSTART and MAGREPSTOP

The MAGREPSTART and MAGREPSTOP options can be run to stop and restart the generation of monthly Image Site Usage messages. MAGREPSTART and MAGREPSTOP are not part of any menu, and should be assigned to a system manager or IRM before they need to be executed.

Note: Image Site Usage messages are used to fulfill FDA requirements related to medical device monitoring. MAGREPSTART and MAGREPSTOP should only be run at the direction of the VistA Imaging Group. Use of these options is not necessary under normal conditions.

Note: If the generation of monthly Image Site Usage messages is suspended using MAGREPSTOP, no monthly messages will be generated until the process is restarted using MAGREPSTART.

12.8.3 Watermarking Messages

When a patient's Advance Directive Note is rescinded, the images that are attached to that note are queued for watermarking with the text "Rescinded". As part of the watermarking process, the subscribers of the G.MAG SERVER mail group will receive an email with information about the status of the operation when:

- Watermarking is successful
- Watermarking fails

12.8.3.1 “Rescinded” Watermarking Succeeded

Following is an example of the email message generated when the image was watermarked with “Rescinded”:

```

Subj: Import API Report  [#31292] 06/22/11@08:14  8 lines
From: PROVIDER, ONE  In 'IN' basket.  Page 1
-----
0) 1^1 Image(s) Copied OK. 0 Errors.
1) MAGRSND;3110622.081451.3
2) 31
3) RESCINDED IMAGE FILE^\\SERVER1\IMAGE1$\SLA0\00\00\02\05\SLA00000020542.TIF

The preceding array was generated by
the VistA Imaging Import API while
processing a 'RESCIND' Image action.

Enter message action (in IN basket): Ignore//

```

12.8.3.2 “Rescinded” Watermarking Failed

Following is an example of the email message generated if the image could not be watermarked with “Rescinded”.

```

Subj: Import API Report  [#31341] 06/23/11@09:52  9 lines
From: PROVIDER, ONE  In 'IN' basket.  Page 1
-----
0) 0^Image is already Rescinded.
1) Image(1) 0^<error message for rescind failure>
2) Image(1) RESCIND Action is Canceled.
3) Image(1) IEN: 20924
4) TIU Note: 697

The preceding array was generated by
the VistA Imaging Import API while
processing a 'RESCIND' Image action.

Enter message action (in IN basket): Ignore//

```

12.9 Imaging Site Reports

Imaging Site Reports is an ad hoc reporting tool used to evaluate user productivity and details of the variety of images being created by the VistA Imaging application. The audience for these reports will be the managers of the VistA Imaging application.

12.9.1 Document Counts Report

This is a report of the IMAGE file (#2005) of Image Types for an 'Acquisition Site' and a 'From' and 'To' Date/Time Image Saved date range. The report will give totals for each Acquisition Site, Object Type, for each user, within the Acquisition Site and date range. A grand total of images within the Acquisition Site and date range are given at the end of the report.

```

Select Imaging Site Reports Option: Document Count
* Previous selection: ACQUISITION SITE from A to ZZZ
START WITH ACQUISITION SITE: A//
GO TO ACQUISITION SITE: ZZZ//
  * Previous selection: DATE/TIME IMAGE SAVED from Jan 1,2000 to Feb 6,2007@24:00
  START WITH DATE/TIME IMAGE SAVED: Jan 1,2000// (JAN 01, 2000)
  GO TO DATE/TIME IMAGE SAVED: Feb 6,2007// (FEB 06, 2007)
DEVICE: ;999;9999 TELNET
Document Count
Sort Criteria: ACQUISITION SITE from A to ZZZ, DATE/TIME IMAGE SAVED from Jan 1,2000
DATE/TIME IMAGE OBJECT
SAVED TYPE TYPE INDEX IMAGE SAVE BY
-----
ACQUISITION SITE: ACQUISITION 1
MAR 10,2000 08:00 DOCUMENT ADVANCE DIRECTI VISTAIMAGING,FOUR
APR 3,2000 17:31 DOCUMENT ADVANCE DIRECTI VISTAIMAGING,ONE
APR 3,2000 17:36 DOCUMENT FLOWSHEET VISTAIMAGING,ONE
APR 3,2000 17:57 DOCUMENT MEDICAL RECORD VISTAIMAGING,ONE
APR 3,2000 18:01 DOCUMENT MISCELLANEOUS D VISTAIMAGING,ONE
APR 3,2000 18:07 DOCUMENT DIAGRAM VISTAIMAGING,ONE
APR 3,2000 18:07 DOCUMENT DIAGRAM VISTAIMAGING,ONE
APR 3,2000 18:10 DOCUMENT FLOWSHEET VISTAIMAGING,ONE
APR 3,2000 18:14 DOCUMENT MISCELLANEOUS D VISTAIMAGING,ONE
APR 3,2000 18:18 DOCUMENT MISCELLANEOUS D VISTAIMAGING,ONE
APR 3,2000 18:23 DOCUMENT CONSENT VISTAIMAGING,ONE
APR 3,2000 18:28 DOCUMENT MEDICAL RECORD VISTAIMAGING,ONE
AUG 2,2000 10:01 DOCUMENT ADVANCE DIRECTI VISTAIMAGING,ONE
SEP 28,2000 11:41 DOCUMENT CONSULT VISTAIMAGING,TWO
SEP 28,2000 11:50 DOCUMENT CONSULT VISTAIMAGING,TWO
MAY 31,2001 11:42 DOCUMENT MISCELLANEOUS D IMAGING,TEAM
AUG 21,2001 17:54 DOCUMENT ADVANCE DIRECTI VISTAIMAGING,TWO
AUG 21,2001 18:53 DOCUMENT MISCELLANEOUS D VISTAIMAGING,TWO
APR 11,2002 11:10 DOCUMENT VISIT RECORD VISTAIMAGING,THREE
APR 11,2002 11:10 DOCUMENT VISIT RECORD VISTAIMAGING,THREE
AUG 14,2002 19:21 DOCUMENT ALLIED VETERAN TESTER,IMAGING
AUG 14,2002 19:21 DOCUMENT ALLIED VETERAN TESTER,IMAGING
APR 17,2003 17:31 DOCUMENT ADVANCE DIRECTI VISTAIMAGING,TWO
APR 17,2003 17:40 DOCUMENT CONSENT VISTAIMAGING,TWO
APR 17,2003 17:48 DOCUMENT ADVANCE DIRECTI VISTAIMAGING,TWO
APR 17,2003 17:50 DOCUMENT CONSENT VISTAIMAGING,TWO
MAY 17,2004 19:17 DOCUMENT VISTAIMAGING,ONE
SEP 16,2004 06:42 DOCUMENT VISTAIMAGING,FIVE
NOV 17,2004 09:45 DOCUMENT IMAGE VISTAIMAGING,ONE
NOV 17,2004 09:46 DOCUMENT IMAGE VISTAIMAGING,ONE
NOV 17,2004 09:47 DOCUMENT IMAGE VISTAIMAGING,ONE
NOV 22,2004 09:12 DOCUMENT MEANS TEST (10- VISTAIMAGING,FIVE
NOV 22,2004 09:12 DOCUMENT MEANS TEST (10- VISTAIMAGING,FIVE
NOV 22,2004 12:29 DOCUMENT MEANS TEST (10- VISTAIMAGING,FIVE
NOV 22,2004 12:29 DOCUMENT MEANS TEST (10- VISTAIMAGING,FIVE
SUBCOUNT 35
COUNT 35

```

12.9.2 Image Count by User Report

This is a report of the IMAGE file (#2005) of Image Types for an 'Acquisition Site' and a 'From' and 'To' Date/Time Image Saved date range. The report will give totals for each Acquisition Site, Object Type, for each user, within the Acquisition Site and date range. A grand total of images within the Acquisition Site and date range are given at the end of the report.

```

Select Imaging Site Reports Option: image Type Count by User
* Previous selection: ACQUISITION SITE from A to ZZZ
START WITH ACQUISITION SITE: A//
GO TO ACQUISITION SITE: ZZZ//
  * Previous selection: DATE/TIME IMAGE SAVED from Jan 1,2000 to Apr 11,2006@24:
00
  START WITH DATE/TIME IMAGE SAVED: Jan 1,2000// (JAN 01, 2000)
  GO TO DATE/TIME IMAGE SAVED: Apr 11,2006// (APR 11, 2006)
    * Previous selection: IMAGE SAVE BY from A to ZZZZ
    START WITH IMAGE SAVE BY: A//
    GO TO IMAGE SAVE BY: ZZZZ//
      * Previous selection: OBJECT TYPE from A to ZZZZ
      START WITH OBJECT TYPE: A//
      GO TO OBJECT TYPE: ZZZZ//
DEVICE: ;999;999 TELNET
Image Type Count by User
Sort Criteria: ACQUISITION SITE from A to ZZZ, DATE/TIME IMAGE SAVED from Jan 1,2000 to Apr
11,2006@24:00, I
-----
          ACQUISITION SITE: ACQUISITION SITE 1

          VISTAIMAGING, ONE

DOCUMENT
SUBCOUNT                8

STILL IMAGE
SUBCOUNT                23

XRAY
SUBCOUNT                17

XRAY GROUP
SUBCOUNT                37

XRAY JPG
SUBCOUNT                2
SUBCOUNT                87

          CAMP, ONEHUNDREDONE

STILL IMAGE
SUBCOUNT                1

XRAY GROUP
SUBCOUNT                1
SUBCOUNT                2

          CAMP, SIX

XRAY GROUP
SUBCOUNT                1
SUBCOUNT                1

          VISTAIMAGING, TWO

DOCUMENT
SUBCOUNT                2

XRAY
SUBCOUNT                2

XRAY GROUP
SUBCOUNT                2
SUBCOUNT                6

```

VISTAIMAGING, THREE	
TEXT	
SUBCOUNT	111
XRAY	
SUBCOUNT	2848
XRAY GROUP	
SUBCOUNT	49
SUBCOUNT	3008
VISTAIMAGING, FOUR	
DICOM IMAGE	
SUBCOUNT	3
DOCUMENT	
SUBCOUNT	1
PATIENT PHOTO	
SUBCOUNT	2
XRAY GROUP	
SUBCOUNT	1
SUBCOUNT	7
VISTAIMAGING, FIVE	
ADOBE	
SUBCOUNT	3
DICOM IMAGE	
SUBCOUNT	69
DOCUMENT	
SUBCOUNT	16
MOTION VIDEO	
SUBCOUNT	5
PATIENT PHOTO	
SUBCOUNT	2
STILL IMAGE	
SUBCOUNT	81
XRAY	
SUBCOUNT	1181
XRAY GROUP	
SUBCOUNT	77
SUBCOUNT	1434
IMAGING, TEAM	
DOCUMENT	
SUBCOUNT	1
XRAY	
SUBCOUNT	1
XRAY GROUP	

SUBCOUNT	1
SUBCOUNT	3
VISTAIMAGING, SIX	
DICOM IMAGE SUBCOUNT	2
DOCUMENT SUBCOUNT	5
STILL IMAGE SUBCOUNT	1
XRAY SUBCOUNT	1
SUBCOUNT	9
VISTAIMAGING, SEVEN	
COLORSCAN SUBCOUNT	5
STILL IMAGE SUBCOUNT	50
XRAY GROUP SUBCOUNT	17
SUBCOUNT	72
POSTMASTER	
XRAY SUBCOUNT	1
SUBCOUNT	1
VISTAIMAGING, EIGHT	
XRAY SUBCOUNT	6
XRAY GROUP SUBCOUNT	1
SUBCOUNT	7
TESTER, IMAGING	
DOCUMENT SUBCOUNT	2
STILL IMAGE SUBCOUNT	4
XRAY SUBCOUNT	6
XRAY GROUP SUBCOUNT	8
SUBCOUNT	20
SUBCOUNT	4657
COUNT	4657

12.9.3 Means Test Report

This is a report of the IMAGE file (#2005) sorted by 'Acquisition Site', 'From' and 'To' Date/Time Image Saved date range, Export Location = ALL (including null), and Index Type From 'MEANS' to 'MEANSZ'. Report detail will include: Acquisition Site, Patient Name, SSN, Index Type, Date/Time Image Saved, and Export Location.

```
Select Imaging Site Reports Option: MEANS TEST
Right Margin for this report is 132
* Previous selection: ACQUISITION SITE from A to ZZZ
START WITH ACQUISITION SITE: A//
GO TO ACQUISITION SITE: ZZZ//
* Previous selection: DATE/TIME IMAGE SAVED from Jan 1,1960 to Jun 6,2006@24:0
0
START WITH DATE/TIME IMAGE SAVED: Jan 1,1960// (JAN 01, 1960)
GO TO DATE/TIME IMAGE SAVED: Jun 6,2006// (JUN 06, 2006)
DEVICE: ;999;999 TELNET
MEANS TEST
Sort Criteria: ACQUISITION SITE from A to ZZZ, DATE/TIME IMAGE SAVED from Jan 1,1960 to Jun
6,2006@24:00,
PATIENT                SSN      TYPE INDEX                Date      EXPORT
LOCATION
-----
ACQUISITION SITE: ACQUISITION SITE 1
RRRRR,AAAAAAAA        R0000 MEANS TEST (10-10EZ)      01/01/1900
RRRRR,AAAAAAAA        R0000 MEANS TEST (10-10EZ)
RRRRR,AAAAAAAA        R0000 MEANS TEST (10-10EZ)
-----
SUBCOUNT                3
RRRRR,AAAAAAAA        R0000 MEANS TEST (10-10EZ)      MAG1-SLC
-----
SUBCOUNT                1
-----
SUBCOUNT                4
-----
COUNT                   4
```

12.9.4 Package Index Contains 'Note' Report

This is a report of the IMAGE file (#2005) sorted by 'Acquisition Site', 'From' and 'To' Date/Time Image Saved date range, Short Description, and Package index containing 'NOTE'. Report detail will include: Acquisition Site, Patient Name, SSN, Short Description, Date/Time Image Saved, and Image Saved by. Sub-counts and counts are given per Scanned By, with Short Description, within Patient.

```
Select Imaging Site Reports Option: Package Index Contains 'Note'
Right Margin for this report is 132
* Previous selection: ACQUISITION SITE from A to ZZZ
START WITH ACQUISITION SITE: A//
GO TO ACQUISITION SITE: ZZZ//
* Previous selection: DATE/TIME IMAGE SAVED from Jan 1,1960 to Jun 6,2006@24:0
0
START WITH DATE/TIME IMAGE SAVED: Jan 1,1960// (JAN 01, 1960)
GO TO DATE/TIME IMAGE SAVED: Jun 6,2006// (JUN 06, 2006)
DEVICE: ;999;999 TELNET
Package Index Contains 'Note'
Sort Criteria: ACQUISITION SITE from A to ZZZ, DATE/TIME IMAGE SAVED from Jan 1,1960 to Jun
6,20
PATIENT                SSN      DOC
-----
ACQUISITION SITE: ACQUISITION SITE 1
VIPATIENT,ONE        V0000 Diagram Neuro Dermatomes
```

SUBCOUNT	1		
VIPATIENT, TWO	V1111	ADVANCE DIRECTIVE	

SUBCOUNT	1		
VIPATIENT, ONE	V0000	Advance Directive	

SUBCOUNT	1		
		MICU Flowsheet	

SUBCOUNT	1		
		AFIP Kidney Biopsy Rpt	

SUBCOUNT	1		
		Geriatrics Referral	

SUBCOUNT	1		
		Diagram	
		OPHTHOMOLOGY	
		OPHTHOMOLOGY	

SUBCOUNT	3		
		Post Anesthesia Flowsheet	

SUBCOUNT	1		
		Nursing MICU Admission	

SUBCOUNT	1		
		Audiological Evaluation	

SUBCOUNT	1		
		Pre-anesthesia Consent	

SUBCOUNT	1		
		Manometry Rpt	

SUBCOUNT	1		
		Home based health care visit	
		NURSING NOTE	
		NURSING NOTE	
		NURSING NOTE	
		NURSING NOTE	
		NURSING NOTE	
		NURSING NOTE	

SUBCOUNT	7		
VIPATIENT, THREE	V3333	ADVANCE DIRECTIVE	

SUBCOUNT	1		
VIPATIENT, FOUR	V4444	CATH May 02, 2001	
		CATH May 02, 2001	

SUBCOUNT	2		
		CATH May 02, 2001	
		CATH May 02, 2001	
		CATH May 02, 2001	
		CATH May 02, 2001	
		CATH May 02, 2001	
		CATH May 02, 2001	
		CATH May 02, 2001	

	CONSULT NURSE MEDICAL WOUND SPEC INPT
---	-----
SUBCOUNT	2
	CONSULT NURSE MEDICAL WOUND SPEC INPT
---	-----
SUBCOUNT	1
VIPATIENT ,THREE	V3333 PCC ESTABLISHED INTERMEDIATE
	PCC ESTABLISHED INTERMEDIATE
	PCC ESTABLISHED INTERMEDIATE
---	-----
SUBCOUNT	3
VIPATIENTSIX ,PATIENT	S6666 NURSING NOTE
---	-----
SUBCOUNT	1
VIPATIENT ,EIGHT	V8888 DERMATOLOGY NOTE
	DERMATOLOGY NOTE
---	-----
SUBCOUNT	2
	DERMATOLOGY NOTE
---	-----
SUBCOUNT	1
VIPATIENT ,NINE	V9999 ADVANCE DIRECTIVE
---	-----
SUBCOUNT	1
	INFORMED CONSENT
---	-----
SUBCOUNT	1
VIVAPAT ,ONE	V0987 ADVANCE DIRECTIVE
	ADVANCE DIRECTIVE
---	-----
SUBCOUNT	2
	INFORMED CONSENT
	INFORMED CONSENT
---	-----
SUBCOUNT	2
INTERESTING ,CASES	I7312 DERMATOLOGY NOTE
	DERMATOLOGY NOTE
---	-----
SUBCOUNT	2
	DERMATOLOGY NOTE
	DERMATOLOGY NOTE
---	-----
SUBCOUNT	2
	ADVANCE DIRECTIVE
	ADVANCE DIRECTIVE
---	-----
SUBCOUNT	2
	ADVANCE DIRECTIVE
---	-----
SUBCOUNT	1
VIVAPAT ,TWO	V3412 WOUND/OSTOMY NOTE
---	-----
SUBCOUNT	1
	WOUND/OSTOMY NOTE
	WOUND/OSTOMY NOTE
---	-----
SUBCOUNT	2
	WOUND/OSTOMY NOTE
	WOUND/OSTOMY NOTE
---	-----

Chapter 12– External Relations

---	SUBCOUNT		2	WOUND/OSTOMY NOTE
---	SUBCOUNT		1	WOUND/OSTOMY NOTE
---	WOUND, TWO	W3027		WOUND/OSTOMY NOTE
---	SUBCOUNT		6	WOUND/OSTOMY NOTE
---	WOUND, THREE	W7321		WOUND/OSTOMY NOTE
---	SUBCOUNT		2	Uncompressed TIF
---	VIPAT, NINE	V1478		
---	SUBCOUNT		1	OPHTHALMOLOGIST CONSULT NOTE
---	VIPATIENT, FOUR	V4444		OPHTHALMOLOGIST CONSULT NOTE
---	SUBCOUNT		2	OPHTHALMOLOGIST CONSULT NOTE
---	SUBCOUNT		2	OPHTHALMOLOGIST CONSULT NOTE
---	SUBCOUNT		4	OPHTHALMOLOGIST CONSULT NOTE
---	SUBCOUNT		3	OPHTHALMOLOGIST CONSULT NOTE
---	SUBCOUNT		2	Color TIF Test
---	VIPAT, QWE	V2345		
---	SUBCOUNT		1	Color TIF Test Uncompressed
---	SUBCOUNT		1	Color TIF Test 2 Uncompressed
---	SUBCOUNT		1	Color TIF Test 2 Compressed (jpg)
---	SUBCOUNT		1	PCC TELEPHONE NOTE
---	TEST, PATIENT	T3333		
---	SUBCOUNT		1	CARDIOLOGY NOTE
---	VIPATIENT, FOUR	V4444		CARDIOLOGY NOTE
---	SUBCOUNT		2	

---	-----
SUBCOUNT	140
---	-----
COUNT	140

12.10 VistA Site Service

The VistA Site Service is a central repository of information used by Imaging components (such as Clinical Display) to connect to other sites. Using the site service eliminates the need to store other sites' connection information locally. Local Imaging components access the site service using a special entry in the NETWORK LOCATION file (#2005.2) as described in Chapter 18.

The site service stores the following information for each site:

- Three-digit site number
- Site name
- Region ID (VISN number)
- Station number (field #99 in the INSTITUTION file (#4))
- VistA server hostname
- VistA server port number
- VIX server hostname
- VIX server port number

The last two values in the preceding list only apply at sites that have implemented the VistA Imaging Exchange (VIX) service. See the *VIX Administrator's Guide* for details.

Note: If any of the information above changes, you must contact the VistA Imaging development group to have the site service updated. Incorrect or outdated information will interfere with remote image access.

Sites that have implemented a VIX will also need to update their VIX's configuration after the site service has been updated. This is done by re-running the VIX Installation wizard which will detect the new connection information and reconfigure the VIX accordingly. See the *VIX Installation Guide* for more information.

12.11 VistARad External Relations

VistARad is able, optionally, to interface with the following types of non-VistA Imaging applications.

12.11.1 Voice Dictation Software

VistARad can be configured to interface with voice dictation software on the same diagnostic workstation, or elsewhere on the network. When a voice dictation interface is configured, VistARad sends identifying information for the current exam to the dictation software. Currently, Talk and PowerScribe are supported.

12.11.2 Medical Visualization/3D Reconstruction Software

VistARad can be configured to interface with medical visualization/3D reconstruction software on the same diagnostic workstation. When a medical visualization interface is configured, VistARad can send an exam to the visualization software for various manipulations such as multi-planar reconstruction, 3D reconstruction, and PET/CT Fusion. Currently, Toshiba’s Voxar 3D software is supported.

12.11.3 Medical Imaging Resource Center (MIRC) “Teaching File” server

VistARad can be configured to interface with a Medical Imaging Resource Center (MIRC) server. When this interface is configured, VistARad can send an image, an image set, or an entire exam of interest to the server as a “teaching file”. Additionally, VistARad can launch a web browser to the same server, making its teaching file contents available. Only one MIRC server interface can be configured, at any given time, per diagnostic workstation. The MIRC server will not be hosted on the diagnostic workstation.

More information on setting up the interfaces is available from Chapter 3 of the *Imaging Installation Guide*.

Chapter 13 Internal Relations

13.1 Dependencies

13.1.1 Entry/Exit Logic

The VistA Imaging System contains no options that rely on entry or exit logic from other options.

13.1.2 Synchronization

13.1.2.1 Clinical, Diagnostic, and Background Processor Workstations

The VistA Imaging software installed on the VistA Hospital Information System must be synchronized with compatible versions of the software installed on the individual workstations.

13.1.2.2 DICOM Modalities and PACS

The main purpose of the VistA Imaging DICOM Gateway is to act as an interface between external equipment and the VistA Hospital Information System. For each gateway function, in order for that function to be operational, the equipment on both sides of the interface must be up-and-running. In order to test and verify the operational status of equipment, see the *VistA Imaging DICOM Gateway User Manual* for a description of the programs **Ping** and **DICOM_Echo**.

13.1.3 Radiology HL7 v2.1 Protocols

The VistA Imaging DICOM Gateway is dependent on Radiology protocols being active. VistA Imaging must be a subscriber to these protocols. Review the following protocols; the highlighted protocol is the VistA Imaging protocol subscriber. Please review the DICOM Installation manual in the section *VistA - PACS Radiology Interface Setup Instructions* for a step-by-step procedure to setup the protocols.

```
NAME: RA REG                                ITEM TEXT: Rad/Nuc Med exam registered
  TYPE: event driver                          CREATOR: 0
  PACKAGE: RADIOLOGY/NUCLEAR MEDICINE
  DESCRIPTION: This protocol is triggered whenever a Radiology/Nuclear
  Medicine exam is registered. It executes code that creates an HL7 ORM message consisting of
  PID, ORC, OBR and OBX segments. The message contains all relevant information about the exam,
  including procedure, time of registration, procedure modifiers, patient allergies, and
  clinical history.
ITEM: MAGD SEND ORM
  ENTRY ACTION: Q                             TIMESTAMP: 57877,43203
  SENDING APPLICATION: RA-SERVER-IMG          MESSAGE TYPE RECEIVED: ORM
  EVENT TYPE: 001                             PROCESSING ID: PRODUCTION
  VERSION ID: 2.1                             GENERATE/PROCESS ACK ROUTINE: Q
  SUBSCRIBERS: MAGD SEND ORM

NAME: RA RPT
  ITEM TEXT: Rad/Nuc Med report released/verified
  TYPE: event driver                          CREATOR: 0
  DESCRIPTION: This protocol is triggered whenever a Radiology/Nuclear
  Medicine report enters into a status of Verified or Released/Not Verified. It executes code
  that creates an HL7 ORU message consisting of PID, OBR and OBX segments. The message contains
  relevant information about the report, including procedure, procedure modifiers, diagnostic
  code, interpreting physician, impression text and report text.
ITEM: MAGD SEND ORU
  ENTRY ACTION: Q                             TIMESTAMP: 57877,43203
```

```

SENDING APPLICATION: RA-SERVER-IMG      MESSAGE TYPE RECEIVED: ORU
EVENT TYPE: R01                        PROCESSING ID: PRODUCTION
VERSION ID: 2.1                        GENERATE/PROCESS ACK ROUTINE: Q
SUBSCRIBERS: MAGD SEND ORU

NAME: RA CANCEL                        ITEM TEXT: Rad/Nuc Med exam cancellation
TYPE: event driver                     CREATOR: 0
PACKAGE: RADIOLOGY/NUCLEAR MEDICINE
DESCRIPTION: This protocol is triggered whenever a Radiology/Nuclear
Medicine exam is cancelled. It executes code that creates an HL7 ORM message consisting of
PID, ORC, OBR and OBX segments. The message contains all relevant information about the exam,
including procedure, time of cancellation, procedure modifiers, patient allergies and clinical
history.
ITEM: MAGD SEND ORM
ENTRY ACTION: Q                        TIMESTAMP: 57877,43203
SENDING APPLICATION: RA-SERVER-IMG     MESSAGE TYPE RECEIVED: ORM
EVENT TYPE: 001                        PROCESSING ID: PRODUCTION
VERSION ID: 2.1                        GENERATE/PROCESS ACK ROUTINE: Q
SUBSCRIBERS: MAGD SEND ORM

NAME: RA EXAMINED                      ITEM TEXT: Rad/Nuc Med examined case
TYPE: event driver                     CREATOR: 0
PACKAGE: RADIOLOGY/NUCLEAR MEDICINE
DESCRIPTION: This protocol is triggered whenever a Radiology/Nuclear
Medicine exam has reached a status where GENERATE EXAMINED HL7 MSG is Y at that (or at a
lower) status. This message contains all relevant information about the exam, including
procedure, time of registration, procedure modifiers, patient allergies, and clinical history.
ITEM: MAGD SEND ORM
ENTRY ACTION: Q                        TIMESTAMP: 57877,43203
SENDING APPLICATION: RA-SERVER-IMG     MESSAGE TYPE RECEIVED: ORM
EVENT TYPE: 001                        PROCESSING ID: PRODUCTION
VERSION ID: 2.1                        GENERATE/PROCESS ACK ROUTINE: Q
SUBSCRIBERS: MAGD SEND ORM

```

13.1.4 Radiology HL7 v2.4 Protocols

Currently HL7 Version 2.4 is the version of HL7 sanctioned for use in the VA enterprise and the version against which commercial PACS have been tested for conformance. Therefore, the v2.4 protocols will ordinarily be subscribed to by VistA Imaging in preference to the v2.1 protocols described in the previous section.

```

NAME: RA REG 2.4
ITEM TEXT: Rad/Nuc Med exam registered (v2.4 HL7)
TYPE: event driver                     CREATOR: HENDERSON,MIKE
PACKAGE: RADIOLOGY/NUCLEAR MEDICINE
DESCRIPTION: This protocol is triggered whenever a Radiology/Nuclear
Medicine exam is registered. It executes code that creates an HL7 ORM message
consisting of PID, PV1, ORC, OBR, OBX and ZDS segments. The message contains
all relevant information about the exam, including procedure, time of
registration, procedure modifiers, CPT modifiers, patient allergies, and
clinical history.

This protocol is used to trigger v2.4 compliant HL7 messages.
TIMESTAMP: 61817,46605                SENDING APPLICATION: RA-CLIENT-IMG
TRANSACTION MESSAGE TYPE: ORM          EVENT TYPE: 001
VERSION ID: 2.4
RESPONSE PROCESSING ROUTINE: D MAIN^RAHLACK
SUBSCRIBERS: MAGJ PREFETCH/SEND ORM
SUBSCRIBERS: MAGD SEND ORM

NAME: RA RPT 2.4
ITEM TEXT: Rad/Nuc Med report released/verified (v2.4 HL7)
TYPE: event driver                     CREATOR: HENDERSON,MIKE
PACKAGE: RADIOLOGY/NUCLEAR MEDICINE
DESCRIPTION: This protocol is triggered whenever a Radiology/Nuclear
Medicine report enters into a status of Verified or Released/Not Verified. It

```

```

executes code that creates an HL7 ORU message consisting of PID, OBR and OBX
segments. The message contains relevant information about the report,
including procedure, procedure modifiers, diagnostic code, interpreting
physician, impression text and report text.

```

```

This protocol is used to trigger v2.4 compliant HL7 messages.
TIMESTAMP: 61817,46605          SENDING APPLICATION: RA-CLIENT-IMG
TRANSACTION MESSAGE TYPE: ORU    EVENT TYPE: R01
VERSION ID: 2.4
RESPONSE PROCESSING ROUTINE: D MAIN^RAHLACK
SUBSCRIBERS: MAGD SEND ORU

```

```

NAME: RA CANCEL 2.4
ITEM TEXT: Rad/Nuc Med exam cancellation (v2.4 HL7)
TYPE: event driver              CREATOR: HENDERSON,MIKE
PACKAGE: RADIOLOGY/NUCLEAR MEDICINE
DESCRIPTION: This protocol is triggered whenever a Radiology/Nuclear
Medicine exam is cancelled. It executes code that creates an HL7 ORM message
consisting of PID, PV1, ORC, OBR, OBX and ZDS segments. The message contains
all relevant information about the exam, including procedure, time of
cancellation, procedure modifiers, CPT modifiers, patient allergies and

```

```

Enter RETURN to continue or '^' to exit:
clinical history.

```

```

This protocol is used to trigger v2.4 compliant HL7 messages.
TIMESTAMP: 61817,46605          SENDING APPLICATION: RA-CLIENT-IMG
TRANSACTION MESSAGE TYPE: ORM    EVENT TYPE: 001
VERSION ID: 2.4
RESPONSE PROCESSING ROUTINE: D MAIN^RAHLACK
SUBSCRIBERS: MAGD SEND ORM

```

```

NAME: RA EXAMINED 2.4
ITEM TEXT: Rad/Nuc Med examined case (v2.4 HL7)
TYPE: event driver              CREATOR: HENDERSON,MIKE
PACKAGE: RADIOLOGY/NUCLEAR MEDICINE
DESCRIPTION: This protocol is triggered whenever a Radiology/Nuclear
Medicine exam has been edited by the user. It executes code that creates an
HL7 ORM message consisting of PID, PV1, ORC, OBR, OBX and ZDS segments. This
message contains all relevant information about the exam, including procedure,
time of registration, procedure modifiers, CPT modifiers, patient allergies,
and clinical history.

```

```

This protocol is used to trigger v2.4 compliant HL7 messages.
TIMESTAMP: 61817,46605          SENDING APPLICATION: RA-CLIENT-IMG
TRANSACTION MESSAGE TYPE: ORM    EVENT TYPE: 001
VERSION ID: 2.4
RESPONSE PROCESSING ROUTINE: D MAIN^RAHLACK
SUBSCRIBERS: MAGD SEND ORM

```

13.1.5 VistA Imaging ADT Protocols

Beginning with the release of Patch MAG*3.0*49, VistA Imaging uses HL7 messages to communicate ADT (admission / discharge / transfer) events directly to commercial PACS. ADT information had formerly been sent from the VistA DICOM Gateway using customized DICOM protocols, which have since been deprecated.

VistA Imaging generates and sends these messages through the VistA HL7 package using the following protocols.

```

NAME: MAG CPACS A01              TYPE: event driver
CREATOR: HENDERSON,MIKE
DESCRIPTION: This protocol generates headers for IHE-based inpatient
admission messages to be delivered to a commercial PACS system by VistA
Imaging.
SENDING APPLICATION: MAG VISTA IMGNG TRANSACTION MESSAGE TYPE: ADT

```

```

EVENT TYPE: A01                      VERSION ID: 2.4
SUBSCRIBERS: MAG CPACS A01 SUBS

NAME: MAG CPACS A01 SUBS             TYPE: subscriber
CREATOR: HENDERSON,MIKE
DESCRIPTION: This protocol routes inpatient admission messages to a
commercial PACS system.
RECEIVING APPLICATION: MAG COMRCL PACS
EVENT TYPE: A01                      LOGICAL LINK: MAG CPACS
RESPONSE MESSAGE TYPE: ACK

NAME: MAG CPACS A02                 TYPE: event driver
CREATOR: HENDERSON,MIKE
DESCRIPTION: This protocol generates the header for patient transfer
messages to be delivered to a commercial PACS system by Vista Imaging.
SENDING APPLICATION: MAG VISTA IMGNG TRANSACTION MESSAGE TYPE: ADT

Enter RETURN to continue or '^' to exit:
EVENT TYPE: A02                      MESSAGE STRUCTURE: ADT_A02
PROCESSING ID:                       VERSION ID: 2.4
SUBSCRIBERS: MAG CPACS A02 SUBS

NAME: MAG CPACS A02 SUBS             TYPE: subscriber
CREATOR: HENDERSON,MIKE
DESCRIPTION: This protocol routes patient transfer messages to a commercial
PACS system.
RECEIVING APPLICATION: MAG COMRCL PACS
EVENT TYPE: A02                      LOGICAL LINK: MAG CPACS
RESPONSE MESSAGE TYPE: ACK

NAME: MAG CPACS A03                 TYPE: event driver
CREATOR: HENDERSON,MIKE
DESCRIPTION: This protocol generates headers for IHE-based patient
discharge/end visit messages to be delivered to a commercial PACS system by
Vista Imaging.
SENDING APPLICATION: MAG VISTA IMGNG TRANSACTION MESSAGE TYPE: ADT
EVENT TYPE: A03                      MESSAGE STRUCTURE: ADT_A03
VERSION ID: 2.4
SUBSCRIBERS: MAG CPACS A03 SUBS

Enter RETURN to continue or '^' to exit:

NAME: MAG CPACS A03 SUBS             TYPE: subscriber
CREATOR: HENDERSON,MIKE
DESCRIPTION: This protocol routes inpatient patient discharge/end visit
messages to a commercial PACS system.
RECEIVING APPLICATION: MAG COMRCL PACS
EVENT TYPE: A03                      LOGICAL LINK: MAG CPACS
RESPONSE MESSAGE TYPE: ACK

NAME: MAG CPACS A11                 TYPE: event driver
CREATOR: HENDERSON,MIKE
DESCRIPTION: This protocol initializes the A11 message to be sent from Vista
Imaging to commercial PACS.
SENDING APPLICATION: MAG VISTA IMGNG TRANSACTION MESSAGE TYPE: ADT
EVENT TYPE: A11                      VERSION ID: 2.4
SUBSCRIBERS: MAG CPACS A11 SUBS

NAME: MAG CPACS A11 SUBS             TYPE: subscriber
CREATOR: HENDERSON,MIKE
DESCRIPTION: This protocol routes admission cancellation messages to a

Enter RETURN to continue or '^' to exit:
commercial PACS system.
RECEIVING APPLICATION: MAG COMRCL PACS
EVENT TYPE: A11                      LOGICAL LINK: MAG CPACS
RESPONSE MESSAGE TYPE: ACK          SENDING FACILITY REQUIRED?: YES
RECEIVING FACILITY REQUIRED?: YES

NAME: MAG CPACS A12                 TYPE: event driver
CREATOR: HENDERSON,MIKE
DESCRIPTION: This protocol generates headers for IHE-based transfer
cancellation messages to be delivered to a commercial PACS system by Vista
Imaging.
SENDING APPLICATION: MAG VISTA IMGNG TRANSACTION MESSAGE TYPE: ADT

```

```

EVENT TYPE: A12                                VERSION ID: 2.4
SUBSCRIBERS: MAG CPACS A12 SUBS

NAME: MAG CPACS A12 SUBS                       TYPE: subscriber
  CREATOR: HENDERSON,MIKE
  DESCRIPTION: This protocol routes transfer cancellation messages to a
commercial PACS system.
  RECEIVING APPLICATION: MAG COMRCL PACS
  EVENT TYPE: A12                                LOGICAL LINK: MAG CPACS
  RESPONSE MESSAGE TYPE: ACK

Enter RETURN to continue or '^' to exit:

NAME: MAG CPACS A13                             TYPE: event driver
  CREATOR: HENDERSON,MIKE
  DESCRIPTION: This protocol generates headers for IHE-based inpatient
discharge cancellation messages to be delivered to a commercial PACS system by
Vista Imaging.
  SENDING APPLICATION: MAG VISTA IMGNG  TRANSACTION MESSAGE TYPE: ADT
  EVENT TYPE: A13                                VERSION ID: 2.4
SUBSCRIBERS: MAG CPACS A13 SUBS

NAME: MAG CPACS A13 SUBS                       TYPE: subscriber
  CREATOR: HENDERSON,MIKE
  DESCRIPTION: This protocol routes inpatient discharge cancellation messages
to a commercial PACS system.
  RECEIVING APPLICATION: MAG COMRCL PACS
  EVENT TYPE: A13                                LOGICAL LINK: MAG CPACS
  RESPONSE MESSAGE TYPE: ACK

```

13.1.6 Radiology Protocols (VistARad)

Vista Imaging VistARad can be set to automatically prefetch archived images for prior radiology exams. Prefetch is activated by subscribing to the RA REG protocol—the VistARad client protocol is **MAGJ PREFETCH SEND/ORM**. Review the example RA REG protocol below; the bolded protocol is the VistARad protocol subscriber. The Installation Guide has a step-by-step procedure to set up the protocol.

```

NAME: RA REG                                    ITEM TEXT: Rad/Nuc Med exam registered
  TYPE: event driver                            CREATOR: IMAGUSER,ONE
  PACKAGE: RADIOLOGY/NUCLEAR MEDICINE
  DESCRIPTION: This protocol is triggered whenever a Radiology/Nuclear
Medicine exam is registered. It executes code that creates an HL7 ORM message
consisting of PID, ORC, OBR and OBX segments. The message contains all
relevant information about the exam, including procedure, time of
registration, procedure modifiers, patient allergies, and clinical history.
ITEM: MAGD SEND ORM
  ENTRY ACTION: Q                               TIMESTAMP: 58864,51844
  SENDING APPLICATION: RA-SERVER-IMG           TRANSACTION MESSAGE TYPE: ORM
  EVENT TYPE: 001                               VERSION ID: 2.1
  RESPONSE PROCESSING ROUTINE: Q
SUBSCRIBERS: MAGD SEND ORM
SUBSCRIBERS: MAGJ PREFETCH/SEND ORM

```

13.1.7 Patient Movement Protocol (DICOM)

The Vista Imaging DICOM gateway is dependent on the Patient Movement (DGPM MOVEMENT EVENTS) protocol being active. Vista Imaging must be a subscriber to this event protocol. The following is an example of this event protocol; the highlighted protocol is the Imaging protocol subscriber. ATTENTION: This is only pertinent if a Vista Imaging DICOM gateway configuration has been defined. Please review the DICOM Installation manual under

section *VistA - PACS Radiology Interface Setup Instructions* for a step-by-step procedure to setup the protocols.

```

NAME: DGPM MOVEMENT EVENTS          ITEM TEXT: MOVEMENT EVENTS v 5.0
  TYPE: extended action              CREATOR:
  PACKAGE: REGISTRATION
DESCRIPTION:
  At the completion of a patient movement the following events take place through this option:

  1. The PTF record is updated when a patient is admitted, discharged or transferred.

  2. The appointment status for a patient is updated to 'inpatient' for admissions and
  'outpatient' for discharges. Admissions to the domiciliary have an 'outpatient' appointment
  status.

When a patient is admitted, dietetics creates a dietetic patient file entry and creates an
admission diet order. When a patient is discharged, all active diet orders are
discontinued. If a patient is absent or on pass, the diet orders are suspended.
Inpatient Pharmacy cancels all active orders when a patient is admitted, discharged or on
unauthorized absence. A patient can not be given Unit Dose meds unless s/he is admitted to a
ward. The patient can receive IV meds; however.

When a patient is transferred, an inpatient system parameter is used to determine whether or
not the orders should be cancelled. When a patient goes on authorized absence, the inpatient
system parameter is used to determine whether the orders should be cancelled, placed on hold
or no action taken.

When a patient returns from authorized absence any orders placed on hold will no longer be on
hold.

  5. With ORDER ENTRY/RESULTS REPORTING v2.2, MAS OE/RR NOTIFICATIONS may be displayed to
  USERS defined in an OE/RR LIST for the patient. These notifications are displayed for
  admissions and death discharges.

  FILE LINK: GMRD MAIN MENU MIS MANAGER
ITEM: DG MEANS TEST DOM              SEQUENCE: 8
ITEM: DGJ INCOMPLETE EVENT          SEQUENCE: 6
ITEM: DGOERR NOTE                   SEQUENCE: 7
ITEM: DGPM TREATING SPECIALTY EVENT SEQUENCE: 1
ITEM: SD APPT STATUS                SEQUENCE: 2
ITEM: ORU AUTOLIST
ITEM: ORU PATIENT MOVMT
ITEM: FHWMAS
ITEM: GMRADGPM MARK CHART
ITEM: IB CATEGORY C BILLING         SEQUENCE: 10
ITEM: VSIT PATIENT STATUS
ITEM: SC PCMM INPATIENT ACTIVITY
ITEM: SC ASSIGN PC TEAM ON DISCHARGE
ITEM: YS PATIENT MOVEMENT
ITEM: VAFH HL7 INPATIENT CAPTURE    SEQUENCE: 3
ITEM: VAFH HL7 INPATIENT CAPTURE    SEQUENCE: 4
ITEM: MAGD DHCP-PACS ADT EVENTS
ITEM: IVM FINANCIAL QUERY FOR ADMISSION
  TIMESTAMP: 57986,52890
    
```

13.2 VistARad Internal Relations

VistARad interfaces with the following components of VistA Imaging.

13.2.1 VistA Site Service

VistARad will query the VistA Site Service if VistARad is configured to detect a local VistA Imaging Exchange (VIX) server. It may do this even if there is no local VIX available.

13.2.2 VistA Imaging Exchange (VIX) servers

If a local VIX server is accessible, VistARad will query the local VIX for relevant patient exams & ancillary information from other remote sites, including those in the DoD. If configured for remote site monitoring, VistARad will also periodically query the VIX for exam list information from the configured monitored sites. Additional information on configuring VistARad for VIX-enabled reading and list monitoring is available in the “VistARad Settings” and “Monitoring Exam Lists of Remote Sites” sections of the VistARad User Guide.

Chapter 14 Package-Wide Variables

The VistA Imaging System does not contain any package-wide variables.

Chapter 15 Online Documentation

15.1 Online Help

Online help is available from the Help menu for Clinical Display, Clinical Capture, MagSys (clinical workstation configuration manager), Background Processor, Verifier, VistARad, TeleReader and TeleReader Configurator.

Chapter 16 Site-Specific Implementation

16.1 Site-Specific Implementation

16.1.1 Radiology Report Transcription Service

Local routines that automatically upload radiology reports from a transcription service should be reviewed and/or modified to ensure that proper consideration has been made for VistA Imaging. When an image is captured via the DICOM Image Gateway and the radiology case number does not have an existing radiology report entry (in file #74), then the VistA Imaging software creates a report stub entry for that case number with limited information. (See box below -- example of radiology report stub entry made by Imaging.) Please note that the stub report entry has an image pointer stored in the IMAGE field, no report status is on file and the activity log indicates that images were collected. The VistA Imaging System executes a Radiology Package API called CREATE^RARIC to create this entry. The RAD/NUC MED PATIENT file (#70) is also updated with the report pointer in the Report Text field.

Imaging has experienced problems when the auto-upload routine updates the REPORT TEXT field (#17) in the RAD/NUC MED PATIENT file (#70). Often the problems result from the program not expecting the Report file entry to exist at the time of the upload. However, the DICOM image capture process guarantees that at the time the transcribed reports are uploaded to the system, a Report file entry already exists, although no Report text nodes exist. Differences in implementations of the local upload programs at various sites have led to other problems as well. Therefore, if your site uses such a program for uploading and/or updating the Radiology report, you must carefully review all aspects of its functionality in light of the changes introduced by the VistA Imaging System.

```
DAY-CASE#: 031500-6666          PATIENT NAME: IMAGPATIENT,ONE
EXAM DATE/TIME: MAR 15, 2000@13:28  CASE NUMBER: 6666
DATE REPORT ENTERED: MAR 15, 2000
IMAGE: IMAGPATIENT,ONE 666-58-5533 FOOT 3 OR MORE VIEWS
CLINICAL HISTORY: pt s/p multiple 1st ray sx w/ continued pain. Please x-ray weight bearing
right foot.
LOG DATE: MAR 15, 2000@13:59      TYPE OF ACTION: IMAGES COLLECTED  COMPUTER USER:
POSTMASTER
```

Example: Radiology Report stub entry made by the VistA Imaging application.

16.1.2 HL7 MESSAGE TEXT File (#772)

VistA Imaging is a subscriber to the Radiology protocols that create HL7 messages. When Radiology protocols are executed, entries are created in the HL7 MESSAGE TEXT file (#772). The purging of this file is handled by the menu option for this application. Sites are requested to review the purging parameters for this file. Use menu option 'Purge Message Text File Entries' under the HL7 Main menu.

16.1.3 Incomplete DICOM Files Received on the DICOM Image Gateway

During the processing of DICOM files on the DICOM image gateway, it is possible for a modality or a PACS interface to send an incomplete file (possibly just header information without the image information). The image processing routine will log these entries in a temporary file (M global) and check periodically to see if the entire file has been received. If, after an hour's time span, the file is still incomplete, the entry is removed from the temporary file (M global) and the file is renamed by appending “_incomplete” to the filename. These files do remain in the DICOM\IMAGE_IN directory and will require site personnel to research the possible failure. In addition, these files will require manual intervention for file maintenance (deletion). Please see the *VistA Imaging DICOM User Manual* for additional information.

Chapter 17 Database Integrity Checking

The VistA Imaging System performs database integrity checking at the system level and within various applications.

17.1 VistA Imaging MAG SYS MENU

In the VistA Imaging system, the MAG SYS MENU has an Integrity Checker Menu with the following submenus:

- GM Global Move Inconsistency Report
- QA Pointer Inconsistency Report
- SC Scan Database for Integrity Issues

Where	Means
GM	Global Move Inconsistency Report [MAG_IC_RPT_GM] DESCRIPTION: Report from Imaging Integrity Check, limited to items required for Central Office ROUTINE: RPT^MAGCRPT("CO") UPPERCASE MENU TEXT: GLOBAL MOVE INCONSISTENCY REPO
QA	Pointer Inconsistency Report [MAG_IC_RPT_QA] DESCRIPTION: Report from Imaging Integrity Check, including all items required for Quality Assurance ROUTINE: RPT^MAGCRPT("QA") UPPERCASE MENU TEXT: POINTER INCONSISTENCY REPORT
SC	Scan Database for Integrity Issues [MAG_IC_SCAN] DESCRIPTION: Menu option to scan the Imaging database EXIT ACTION: K MAGN100,MAGZ,VALID,Z ROUTINE: RPT^MAGGSQI(.Z,1E11) UPPERCASE MENU TEXT: SCAN DATABASE FOR INTEGRITY IS

17.2 Clinical Display Application

The *Clinical Display Workstation User Manual* contains two references to Questionable Integrity (QI):

- A “Not Viewable” icon is displayed if the user attempts to view an image that has internal references that suggest some degree of integrity risk. For details, see the section *Images That Are Not Viewable Due to an Error*.
- An image that is blocked from view can be attributed to a number of reasons. One is if the image data does not pass the QI check, then the image is marked as QI. For details, see the section *Blocked Images in the Abstracts Window*.

Additionally, see the section *Deleting Images with Questionable Integrity (QI Issues)* in *Appendix C: Deleting Images*.

17.3 VistARad Application

The *VistARad User Guide* contains a reference to a “Severe Alert” icon that is displayed when a user attempts to view an exam and the system detects a data integrity problem with the exam. For details, see the section *Opening Exams*.

17.4 Verifier Application in the Background Processor

The BP Verifier provides a report called the *Imaging Patient Integrity Issues* in the *DFNError Log* file, which displays integrity issues with patient data. For details, see Section 5.7.1.4 *DFN Log File* in the *Background Processor User Manual*.

Chapter 18 Remote Image Views

18.1 Configuration for Remote Image Views

The Remote Image Views functionality uses a Network Location entry that points to the VistA Site Service to determine the server and port of remote VistA databases. This Network Location entry is present at all sites running Patch 45 or later. By default, this Network Location is enabled.

The URL defined in the VistA Site Service Network Location must be accessible to all clients attempting to access remote images.

Patch 111 provides the availability of the Broker Security Enhancement (BSE) for VistA Imaging clients. BSE is a token based authentication method that provides enhanced security over the previously used CAPRI login method.

Patch 94 modifies remote image view functionality in Display and TeleReader to make use of BSE. The client will first use BSE when attempting to connect to remote sites. If BSE fails, the client will use the CAPRI remote site login. When CAPRI is used, the system will generate a log entry to track the usage of the CAPRI authentication method. Using the BSE or CAPRI remote login method does not affect the usability of the applications, and it is transparent to the user.

The Kernel Team will release a patch to disable the CAPRI authentication method after Patch 94 is released. When the Kernel Team disables the CAPRI authentication method, only clients 94 and later will be able to connect to sites for remote image viewing.

18.1.1 Enabling/Disabling Remote Image Views for Site

To enable/disable Remote Image Views for your entire site, you may do so by changing the Operational Status of the NETWORK LOCATION file (#2005.2). Setting the Operational Status to On-Line enables Remote Image Views for your entire site. Setting the Operational Status to Off-Line disables Remote Image Views for your entire site. Enabling and disabling this option does **not** prevent remote sites from accessing your data. This only prevents users at your local site from accessing remote data.

```
If you would like to disable Remote Image Views at your local site, you may do so by modifying the Operation Status field of the VISTASITESERVICE NETWORK LOCATION.
```

```
VA FileMan 22.0
```

```
Select OPTION: ENTER OR EDIT FILE ENTRIES
```

```
INPUT TO WHAT FILE: NETWORK LOCATION// NETWORK LOCATION  
(60 entries)
```

```
EDIT WHICH FIELD: ALL// OPERATIONAL STATUS  
THEN EDIT FIELD:
```

```
Select NETWORK LOCATION: VISTASITESERVICE
```

```
http://siteserver.med.va.gov/VistaWebSvcs/Service.asmx

OPERATIONAL STATUS: On-Line// ?
Code the Network Location ONline/OFFline status
Choose from:
0      Off-Line
1      On-Line
OPERATIONAL STATUS: On-Line// ??

To allow clients at your site to use Remote Image Views, set the VISTASITESERVICE Operational
Status to On-Line. If you would like to disable Remote Image Views at your site, set the
Operational Status to Off-Line.
```

18.1.2 Updating VistA Site Service URL

The remote image viewing capability uses a VistA Site Service to determine the server details of remote VistA systems. The following describes how to change the URL for this service if necessary.

```
If the VistA Site Service URL needs to be changed, you will need to edit the Physical
Reference field for the VISTASITESERVICE entry in the NETWORK LOCATION File.

Example Fileman session:

VA FileMan 22.0

Select OPTION: ENTER OR EDIT FILE ENTRIES

INPUT TO WHAT FILE: NETWORK LOCATION// NETWORK LOCATION
                    (60 entries)
EDIT WHICH FIELD: ALL// PHYSICAL REFERENCE
THEN EDIT FIELD:

Select NETWORK LOCATION: VISTASITESERVICE
http://siteserver.med.va.gov/VistaWebSvcs/Service.asmx

PHYSICAL REFERENCE: http://vhaann26607.v11.med.va.gov/VistaWebSvcs/Service.asmx
                    Replace ??

You can modify the value for the Physical Reference field to the new URL of the VistA Site
Service. Appendix A Error Messages
```

Appendix A: Error Messages

A.1 Clinical Workstation Error Messages

Error Message	Cause(s)/Solutions
You don't have the proper Security Keys to capture LAB images.	The USE CAPTURE KEY field in the IMAGING SITE PARAMETERS file (#2006.1) has been turned on and the user has not been assigned the proper key. Please review the Security Key section in the VistA Imaging Security Guide.
Error in connecting to Server \\servername\image\	Possible causes: <ul style="list-style-type: none"> • The workstation has not been set up properly. • The account used to access the server has not been given the proper security level or has not been set up properly. • The listed server is down. Find the associated error number and use the Help Error Code Lookup option in Imaging Display.
AutoUpdating is disabled. Network Configuration file doesn't exist.	The MAGNET.INI file is not on the Network Update directory. Auto Update is not configured properly. <ol style="list-style-type: none"> 1. Contact network administrator and request that a copy of the MAGNET.INI file be placed in the Network Update directory. 2. Review the VistA Imaging System Installation Guide for proper configuration of Auto Update.
AutoUpdating disabled. The network update directory doesn't exist.	Cannot connect to the directory or it does not exist. <ul style="list-style-type: none"> • User does not have privileges to the distribution directory. • Workstation log-on profile does not connect to Network Update directory. • Contact network administrator.
AutoUpdating disabled. Workstation isn't configured for Auto Updating.	No update directory in the MAG308.INI file under section SYS_AUTOUPDATE for variable DIRECTORY. Run MAGASET.EXE from the Network Update directory. This will automatically define the DIRECTORY entry in the MAG308.INI file for the current workstation.

Error Message	Cause(s)/Solutions
<p>AutoUpdating canceled.</p> <p>No Updates available.</p>	<p>The MAGSETUP.EXE file does not reside in the Network Update directory.</p> <p>Contact the network administrator and request a copy of the MAGSETUP.EXE file be placed on the Network Update directory.</p>
<p>Abstract not found.</p>	<p>Possible causes:</p> <ul style="list-style-type: none"> • The abstract was removed from the server. • The abstract was not generated, or could not be written to the share. • Network problems. • Mapped Image share • Permission to access the share is not granted. <p>Diagnostic process and corrective action:</p> <ul style="list-style-type: none"> • Check file and folder permissions for the image shares. • Check to see if the files exist on the shares.
<p>ERROR_ACCESS_DENIED</p>	<p>Possible causes:</p> <ul style="list-style-type: none"> • Account or share permissions are not set up properly. • Account password was changed on the server, but not updated in the IMAGING SITE PARAMETERS file (#2006.1).
<p>Error connecting to server.</p>	<p>Possible causes:</p> <ul style="list-style-type: none"> • Incorrect configuration. <p>Diagnostic process and corrective action:</p> <ul style="list-style-type: none"> • Check for error number in the message history window. Look it up using the Error Lookup option on the Imaging Display help menu. • Use ping or tracert to check the availability of the file server.

Error Message	Cause(s)/Solutions
0 Images on file.	<p>Possible causes:</p> <ul style="list-style-type: none"> • Normal condition. <p>Diagnostic process and corrective action:</p> <ul style="list-style-type: none"> • This refers to images, not EKGs! A patient can have one without the other. Check "user preferences" to see if "always display EKG window" is selected. Click the EKG button to display the EKGs.
The File Does Not Exist - Notify IRM.	<p>Possible causes:</p> <ul style="list-style-type: none"> • Missing or inaccessible file. <p>Diagnostic process and corrective action:</p> <ul style="list-style-type: none"> • Check to see if the file pointed by the database exist and is accessible.
Launching Imaging from CPRS causes RPC Broker dialog for access/verify code.	<p>Possible Causes:</p> <ul style="list-style-type: none"> • Incorrect configuration. <p>Diagnostic process and corrective action:</p> <ul style="list-style-type: none"> • AutoSignon or multiple signon is not enabled for the site (KERNEL SYSTEM PARAMETERS file (#8989.3)) or the user (NEW PERSON file (#200)). • DEFAULT AUTO SIGN-ON can not be set to “Disabled” in Kernel site parameters file.
Error Accessing Group Image - See VistA Error Log.	<p>Possible causes:</p> <ul style="list-style-type: none"> • Database inconsistency. <p>Diagnostic process and corrective action:</p> <ul style="list-style-type: none"> • This error is found on the clinical display when you try to delete an "Abstract not Found" entry. The software identifies this entry as a group image and because you cannot expand the group, it cannot be deleted.

Error Message	Cause(s)/Solutions
<p>No MUSE Servers available.</p>	<p>Possible causes:</p> <ul style="list-style-type: none"> • No MUSE servers are configured in the Network Location file (#2005.2). • All MUSE servers in the Network Location file are configured as off-line. <p>Diagnostic process and corrective action:</p> <ul style="list-style-type: none"> • Add the MUSE Servers to the Network Location file. • Bring the MUSE servers back On-Line in the Network Location file.
<p>No MUSE Servers available. Select a failed connection to see the error code.</p>	<p>Possible causes:</p> <ul style="list-style-type: none"> • The application failed to connect to the all of the MUSE Servers. • MUSE servers are down. <p>Diagnostic process and corrective action:</p> <ul style="list-style-type: none"> • Click on a specific connection to see the error details.
<p>No Muse EKGs on File for this patient</p>	<p>Possible causes:</p> <ul style="list-style-type: none"> • Patient ID (SSN) entered does not match MUSE patient ID. • The Patient has no Muse EKGs on file. <p>Diagnostic process and corrective action:</p> <ul style="list-style-type: none"> • Verify that the entered patient ID (SSN) is identical in the MUSE and VistA databases.
<p>Error connecting to MUSE Server \\<ServerName>\<ServerShare>: status =53</p>	<p>Possible causes:</p> <ul style="list-style-type: none"> • The network path was not found. • Permission problem on share. • MUSE server down. <p>Diagnostic process and corrective action:</p> <ul style="list-style-type: none"> • Be sure you can ping the server. • Ensure that the Physical Reference field in the Network Location file (#2005.2) is defined correctly.

Error Message	Cause(s)/Solutions
Error connecting to MUSE Server \\<ServerName>\<ServerShare>: status =104	Possible causes: <ul style="list-style-type: none"> • Error message displayed when user selects a failed connection in the EKG selection list. The MUSE API flag is not enabled. Diagnostic process and corrective action: <ul style="list-style-type: none"> • This requires a call to GE so they can enable the API by installing a VOL000\system\sysinf\MUSEAPI.FIX file. • If this file was created with Notepad, be sure that it is not named MUSEAPI.FIX.TXT. Notepad adds a .txt extension when it creates a file.
Invalid File : MUSEAPI.DLL Call IRM to get an updated file.	Possible causes: <ul style="list-style-type: none"> • The MUSE API files were not installed correctly. • The MUSE API files are not installed. Diagnostic process and corrective action: <ul style="list-style-type: none"> • Call IRM for help • Reinstall VistA Imaging.

A.2 BP Error Messages

A.2.1 General BP Error Messages

Error Message	Cause(s)/Solutions
'CC:createcontext("MAG WINDOWS") could not be established!'	The user who is logging into the background processor does not have the MAG WINDOWS security key assigned. Assign the MAG WINDOWS security key to this user.
'Broker Connection to server could not be established!'	VistA RPC Broker is not currently in a listening state. OR The application has timed out. <ol style="list-style-type: none"> 1. Close the application and restart. 2. Check with the VistA system manager for the status of the Broker listener.
'Source File does not exist: '+'Filepath''.	The VistA Imaging file reference was not updated. The verifier will update. NO action is necessary.

Error Message	Cause(s)/Solutions
<p>Background processor is halting most mornings.</p>	<p>Symptom:</p> <ul style="list-style-type: none"> • Background processor inoperable. <p>Possible Causes:</p> <ul style="list-style-type: none"> • RPC time-out. <p>Diagnostic Process and Corrective Action:</p> <ul style="list-style-type: none"> • It is likely that the tape backup procedure is stopping the job that controls the link between the BP and the HIS system. Check the backup procedure for code that kills VMS jobs. • Restart the Background processor.
<p>Broker error - sign on not completed.</p>	<p>Symptom:</p> <ul style="list-style-type: none"> • Error message displayed. <p>Possible Causes:</p> <ul style="list-style-type: none"> • Network Timeout. <p>Diagnostic Process and Corrective Action:</p> <ul style="list-style-type: none"> • The broker connection timed out on the current process. Close the BP window, re-logon (VistA access/verify), and start a new BP session. The problem appears to be related to the completion of the VistA backup job.

Error Message	Cause(s)/Solutions
<p>Unable to copy to Jukebox. Not enough write cache available.</p>	<p>Symptom:</p> <ul style="list-style-type: none"> • Informational message displayed. <p>Possible Causes:</p> <ul style="list-style-type: none"> • Temporary condition. <p>Diagnostic Process and Corrective Action:</p> <ul style="list-style-type: none"> • This message is informational, indicating that the memory set aside to cache data to be written to the jukebox is temporarily full. This causes the BP software to pause sending data to the write cache. This process will automatically restart as the jukebox writes the data backlog to optical, since this will free memory in the write cache. <p>Check for corruption in the database: Stop the BP and stop the DE Jukebox service E:\dex\bin\dbcache /report Check for inconsistencies E:\dex\bin\dbcache /fixall Restart the DE jukebox service and check that cache begins to clear. Then, restart the BP.</p> <p>The background processor idles (goes to "sleep") waiting for space to be made available on IMM2. Check for Disk Extender errors on IMM2.</p> <p>Check local network connectivity. The disks are probably not full. Clear the ReadCache (via DEAdmin) because if it and the WriteCache total to more than 90%, then it's the ReadCache that may be preventing the WriteCache from being accessed (no headroom).</p> <p>Check to see that the new media has been added, online, and inserted into the write path. From IMM2, check network continuity: DIR \\VHAxxxJB1\IMAGE1 Is any media jammed in the jukebox shelf or drive? Was any password changed?</p> <p>Ultimately, shutdown, power-off/on, boot both the server and the jukebox. Make sure the jukebox robotics have settled and all LEDs are green. Then start IMM2. Watch start-up screens for errors.</p>

Error Message	Cause(s)/Solutions
<p>DOS ERROR The Disk is Full.</p>	<p>Symptom:</p> <ul style="list-style-type: none"> • Error message displayed. <p>Possible Causes:</p> <ul style="list-style-type: none"> • DX Cache Inconsistency. <p>Diagnostic Process and Corrective Action:</p> <ul style="list-style-type: none"> • Chances are that the disk is NOT full, but that the jukebox has a cache inconsistency. On IMM2, do the following: D:\DEX\BIN>dbcache /report then, if errors exist, D:\DEX\BIN>dbcache /fixall • Check to see if there is free space available on media in the write path.
<p>Could not connect to the DiskExtender service.</p>	<p>Symptom:</p> <ul style="list-style-type: none"> • Error message displayed. <p>Possible Causes:</p> <ul style="list-style-type: none"> • SCSI Failure • Power Failure • Incorrect shutdown <p>Diagnostic Process and Corrective Action:</p> <ul style="list-style-type: none"> • If starting the DE console fails, check the DE event log: D:\DEX\LOGS\event.txt Chances are, the cache is corrupt and needs to be fixed: D:\DEX\BIN>dbcache /report D:\DEX\BIN>dbcache /fixall Then, restart the DE console, invoke the DE Administrator and use the 'stoplight' to start the services. Then, the background processor should be restarted (if it had errored out). Also check that the SCSCI interface board is properly seated in its slot.

Error Message	Cause(s)/Solutions
<p>The RPC server is unavailable - Error code 1722.</p>	<p>Symptom:</p> <ul style="list-style-type: none"> • Error message displayed. <p>Possible Causes:</p> <ul style="list-style-type: none"> • Power Failure • SCSI error <p>Diagnostic Process and Corrective Action:</p> <ul style="list-style-type: none"> • If starting the DE console fails, check the DE event log: E:\DEX\LOGS\event.txt <p>When DE service tries to start - there are repetitive "going to sleep/thread woke up/Drive thread waiting for initialization" messages and attempts to reinitialize the database. This may go on for several minutes and finally fail. This is indicative of a hardware failure, too.</p> <p>---</p> <p>Chances are, the cache is corrupt and needs to be fixed: E:\DEX\BIN>dbcache /report E:\DEX\BIN>dbcache /fixall</p> <p>Then, restart the DE console, invoke the DE Administrator and use the 'stoplight' to start the services. Then, the background processor should be restarted (if it had error-ed out).</p>
<p>Unable to retrieve images from jukebox</p>	<p>Symptom:</p> <ul style="list-style-type: none"> • Error message displayed. <p>Possible Causes:</p> <ul style="list-style-type: none"> • Authorization Failure <p>Diagnostic Process and Corrective Action:</p> <ul style="list-style-type: none"> • Check the Net Username and Net Password in the IMAGING SITE PARAMETERS file (#2006.1). This grants access to the magnetic shares. Another problem with accessing images from the jukebox is due to a limitation with the Diskextender software 3.20.90. It will only grant access to the account in the 2006.1 fields pertaining to the Net User Name and Net Password if that same account exists locally on the Jukebox server (IMM2). Also check that the SCSI board is properly seated in its slot.

Error Message	Cause(s)/Solutions
<p>JBSleep (JBTOHD) Jukebox is currently offline</p>	<p>Symptom:</p> <ul style="list-style-type: none"> • Error message displayed <p>Possible Causes:</p> <ul style="list-style-type: none"> • DX is not running • Authorization Failure <p>Diagnostic Process and Corrective Action:1)</p> <ol style="list-style-type: none"> 1. Check to see that Disk Extender services are running. Check the Disk Extender event log. 2. Check that the person who logged into this workstation (background processor) has rights and permissions on the jukebox server and the image server. This can be tested from the DOS prompt by typing the format, as shown in the following example: C:\>DIR \\VHAxxxJB1\IMAGE1
<p>TGA: not copied. 39: There is not enough space on the disk.</p>	<p>Symptom:</p> <ul style="list-style-type: none"> • Error message displayed. <p>Possible Causes:</p> <ul style="list-style-type: none"> • Disk Full <p>Diagnostic Process and Corrective Action:</p> <ol style="list-style-type: none"> 1. Check the background processor to see that it's having trouble writing to the jukebox or writing to magnetic. 2. Go to IMM2 and open the Disk Extender Administration. 3. Check that media exist in the Media Path. 4. Check that enough media exist in the Write Path.
<p>Jukebox Error=27. Unhandled move error.</p>	<p>Symptom:</p> <ul style="list-style-type: none"> • Displayed Error message <p>Possible Causes:</p> <ul style="list-style-type: none"> • Cache corruption <p>Diagnostic Process and Corrective Action:</p> <ul style="list-style-type: none"> • A file in the write cache may be corrupt. Rename the corrupt Cache file, and then run the DBCACHE utility in the \DEX\BIN folder.

Error Message	Cause(s)/Solutions
<p>Remote procedure call failed; did not execute; Error code 1727</p>	<p>Symptom:</p> <ul style="list-style-type: none"> • Jukebox is not accessible. <p>Possible Causes:</p> <ul style="list-style-type: none"> • Jukebox failure <p>Diagnostic Process and Corrective Action:</p> <ul style="list-style-type: none"> • A platter may not have successfully mounted or the service is not running. <p>You may also probably see: "could not collect partition information". This error usually occurs during start-up and is normal, as the jukebox has not finished inventorying the platters.</p> <p>Worst case, use the DEX Console to take the jukebox offline, then back online, setting "inventory" for only the platters preceding and following (and including) the problem platter. The jukebox should recover.</p>
<p>Could not collect partition info; handle invalid; Error code 6.</p>	<p>Symptom:</p> <ul style="list-style-type: none"> • Jukebox is not accessible. <p>Possible Causes:</p> <ul style="list-style-type: none"> • Jukebox failure <p>Diagnostic Process and Corrective Action:</p> <ul style="list-style-type: none"> • The service is not started.

Error Message	Cause(s)/Solutions
<p>Not enough file server space.</p>	<p>Symptom:</p> <ul style="list-style-type: none"> • Warning message on Background Processor • DICOM Gateways Image Processing halts with an error <p>Possible Causes:</p> <ul style="list-style-type: none"> • Disk free space reaching low limits • One or more RAID volumes offline or inaccessible <p>Diagnostic Process and Corrective Action:</p> <ul style="list-style-type: none"> • Ensure that all RAID shares are online and accessible from the network. • If disk space on the image servers is getting low, you must do a purge operation from the BP. <ol style="list-style-type: none"> 1) Stop BP. 2) Edit->Purge Parameters. 3) File->Purge. 4) Click "Start" button in top middle of the screen and wait for the purge to complete. • Add RAID share(s) to the active RAID group.
<p>Jukebox copy not overwritten.</p>	<p>Symptom:</p> <ul style="list-style-type: none"> • Informational message <p>Possible Causes:</p> <ul style="list-style-type: none"> • Normal condition <p>Diagnostic Process and Corrective Action:</p> <ul style="list-style-type: none"> • This is a normal condition after a purge. The error message is actually notification that the pointer has been reset. <p>Run the verifier to confirm the consistency of the files on the jukebox and the pointers on the VistA HIS (#2005).</p>

Error Message	Cause(s)/Solutions
Menus are being rebuilt. Please try again later.	<p>Symptom:</p> <ul style="list-style-type: none"> Warning message <p>Possible Causes:</p> <ul style="list-style-type: none"> HIS is busy. <p>Diagnostic Process and Corrective Action:</p> <ul style="list-style-type: none"> You will also get a message: List index out of bounds (0). <p>This error is a result of the BP losing connection with the HIS. The user must restart the BP.</p> <p>This scenario occurs when the BP cannot communicate with the Broker process on the HIS system. The Broker process is locked out by a higher priority job, backups are being run that lock the system for several minutes, etc.</p>
'EBrokerError:'+ Filename	<p>RPC is not available. Or Application timeout.</p> <p>Restart application.</p>
'EBrokerError:'+ IEN	<p>RPC is not available. Or Application timeout.</p> <p>Restart application.</p>
'This Workstation is not yet configured!'	<ol style="list-style-type: none"> There is no database entry for this workstation. Use the BP Workstation menu and select: Edit Add BP workstation menu option. The Workstation has not been assigned any Queue types to process. Use the BP Workstation menu and select: Edit BP Workstation Parameters.
'Invalid jukebox volume name: '+ "Drive/path "+ "Volume name"'	<p>The jukebox share label is not consistent with the VistA Jukebox file volume name.</p> <ol style="list-style-type: none"> Check the volume name in the site configuration (Edit Site Imaging Site Parameters – Jukebox default) Check the network properties of the Jukebox share validate that the label is 'DEX'.

Broker Failures

When the connection to the Broker fails:

- Verify the Port and Server are correct in the registry.
- Close and restart the application.
- Open a DOS window and use the ping command to see if the VistA server is available
- Verify that the listener is running in VistA
- Validate that the Access/Verify codes have not expired.
- Check the security on the Access/Verify account. Make sure:
 - The MAG SYSTEM security key is assigned.
 - The MAG WINDOWS menu option is assigned.

Not Enough Server Cache

This message indicates that:

- The share on the server is not accessible. Follow the steps in the Troubleshooting section for help.
- The free space on the Image shares is below the % Server Reserve
 - Disable the Auto Write Location Update option.
 - Set the write location manually to a share with cache space available.
 - If no share has adequate free space, create a second BP Server and manually launch a Purge to run on all shares. When the Purge has run and generated free space on a share, set the Write location manually to that share.

Not Enough Process Memory

Close all the applications and reboot the server. If the problem persists, contact the National Helpdesk.

Not Enough Write Cache Available

This message refers to the DiskXtender cache on the jukebox and indicates there is no free space on the jukebox share, or for Archive Appliance sites a possible space issue exists.

- Verify the share is accessible. Follow the steps in the Troubleshooting section for help.
- Click the Extended Drive in DiskXtender to see if there is free space available. Also, use Windows Explorer on the JB server to see if Windows is properly reporting free space.
- Check the Move Group within the DiskXtender application to see if there are platters with available space. If not, add additional optical platters to the Move Group. See the DiskXtender User Manual.
- Run a Drive Scan on the share. See the DiskXtender User Manual.

A.2.2 Queue Processor Application Error Messages

Startup

Message	Explanation	Action
0^Accusoft Control creation error : < error message >	The Import API uses the AccuSoft Image Gear Toolkit to create the watermarked image. If an error occurs during the creation of AccuSoft controls, the error message displays describing the error.	The AccuSoft controls are installed during MAG*3.0*121 installation. If this error message occurs, contact the VistA Imaging system manager. You may need to reinstall MAG*3.0*121 to correct AccuSoft ImageGear problems.
0^Image is missing from input data.	The image to be watermarked is not in the Import Queue Data.	Check the IMAGE file (#2005) to see if the data is corrupt.

Appendix A – Error Messages

Message	Explanation	Action
0^Watermark failure : <error message>	The process of burning the “Rescinded” watermark onto the image file failed.	The AccuSoft ToolKit could not create the watermarked image. Check if the rescinded bitmap exists in the image directory C:\Program Files\vista\Imaging\Bmp\MagRescinded.bmp . You may need to reinstall MAG*3.0*121 to correct AccuSoft ImageGear problems.
Create Process failed'+ProgramName	A system error occurred starting the process	Log a Remedy ticket
Increment queue_name Ptr^Failed	The QUEUE POINTER (#1) in the IMAGE BACKGROUND QUEUE POINTER file (#2006.031) in VistA could not be updated	On the main BP window, use the Edit Refresh Queue Counts to correct the current counts. Close the BP and restart the application.
Initialization Failure^Log Files at: C:\Program Files\Vista\Imaging\BackprocLog\BackProc\BPError.log	Log file could not be created	Check permissions on the log folder
RAID groups not properly configured Use the Network Location Manager to reset your RAID groups	An active RAID Group has no online shares	Make sure online RAID Group has online shares
Requeue Failure trying to Requeue:	An attempt to re-queue a failed queue entry failed	Use the Queue Manager and step past the queue entry. Determine the problem with the entry that would not re-queue.
SetTime Handle – Destin: C:\Program Files\Vista\Imaging\BackprocLog\BackProc\BPError.log Access is Denied	Could not write the Access Date on the log file	Check the file permissions on the log folder listed.
The Background Processor client software is version <i>n.n.n.n</i> . VistA Imaging Host system has version <i>m</i> installed. Please update to compatible client and host software. Shutting down the Background Processor...	The client software that is installed does not match the KIDS version installed on VistA.	Install the correction version of the KIDS and client software.

Message	Explanation	Action
The Patch 39 KIDS install on the VistA host system is required for this Version of the: <i>site name</i> BP Queue Processor	The KIDS file for this most recent patch has not been installed in VistA.	Install the KIDS file on VistA.
The Site parameter context could not be determined. The application will terminate.	The PLACE global is corrupt	Log a Remedy ticket
This server is not yet configured for BP queue task processing!	There is no BP Server name assigned to this server	Create a BP Server through the GUI and assign tasks to it.

Runtime

Message	Explanation	Action
An Abstract for this file is on the Jukebox, a JBTOHD is being queued	ABSTRACT - The abstract pointer on the RAID is empty. The abstract will be copied from the jukebox	None
Could not complete	DELETE - file could not be deleted	Check permissions on RAID share
Could not complete/Requeued	DELETE - file could not be deleted	Check permissions on RAID share
Current RAID Shares^Exception: No RAID group Assigned	The RAID share must be assigned to a RAID Group	On the BP main window, use Edit Network Location Manager to assign the RAID share(s) to a RAID Group.
False Positive Copy <i>filename(Source), filenames ource filesize, filesize(jukebox)</i>	File sizes on source and destination don't match. File not copied.	Determine if images are for different patients
File copied was of size zero	IMPORT - The file size is zero	Resend image from import source
File of size zero created then deleted	MAKEABS - file of zero length was created by Mag_MakeAbs.exe. It was deleted.	Log a Remedy ticket
File was not found	IMPORT - file does not exist on the image share	Resend image from import source

Appendix A – Error Messages

Message	Explanation	Action
<i>filename</i> Source file does not exist.	Could not find source file	Run Verifier to correct VistA pointers
<i>fileshare</i> : Cannot connect to the Export Share.	EXPORT - Cannot map to the remote share	Check for network connectivity. Check permissions..
ForceDirectories failed:	DELETE - could not create directory on jukebox share	Check permissions on jukebox share
Image File type: <i>filename.ext</i> is an Unsupported Format	ABSTRACT - The Full file is not a supported Imaging file type. So the abstract cannot be created.	Examine the "foreign" file and determine if the extension was misnamed.
Jukebox is not available: <i>filepath Volume label</i>	JUKEBOX - the jukebox share is not available	Ping the jukebox server. Check the jukebox share permissions.
Jukebox sourcefile unavailable	JBTOHD - There is no abstract file on the jukebox. The abstract pointer in VistA is not set.	None
JUKEBOX: <i>queue _pointer ^file _extension</i> Not copied	JUKEBOX - Alternate file extension (i.e. .TXT) was not copied	Check file permissions
Login Message^Pausing 3 minutes and will then retry	AUTOLOGIN - could not relog into the Broker	Check for network connectivity.
Login Message^Silent Login attempt failed!	AUTOLOGIN - could not relog into the Broker	Check for network connectivity.
Make AbstractError / abs is already present	ABSTRACT- file already exists at the RAID location specified in VistA	None
Make AbstractError / <i>filename</i>	MAKEABS- the Mag_MakeAbs.exe could not create the abstract file	Log a Remedy ticket
NetConError Using User credentials <i>WIN32_Error</i>	GCC - Could not logon to the remote location with the Username/Password in VistA	Correct the Username/Password for the GCC location in VistA
NetConError, There is no password associated with this Network Location: <i>share_name</i>	GCC - The password field is empty for this Network Location	Enter a password for this GCC location
No Image file entry was created!	IMPORT - an IEN was not created in the image file	Resend image from import source

Message	Explanation	Action
No Jukebox sourcefile available / Attempting Abstract Queue	JBTOHD - There is no abstract file on the jukebox. The abstract pointer in VistA is set. The Queue Processor will attempt to make on from the Full or BIG file.	None
No Tracking ID IMPORT failed	IMPORT - unique Tracking ID parameter is missing from IMPORT	Resend image from import source
No valid RAID share found	IMPORT - no RAID pointer is set in VistA for the image	Resend image from import source
Problem renaming log file: <i>filename</i>	Could not rename log file to a versioned copy	Check permissions on the existing folder/files
<i>queue_pointer</i> ^Size Mismatch <i>queue_type</i> copy not overwritten.	File sizes on source and destination don't match. File not copied.	Determine if images are for different patients
SetFileTime Failed	Could not set Access date on the log file.	None
The jukebox copy: <i>filename</i> does not exist -- attempting a copy...	DELETE -Could not find the file on jukebox shares. Try to copy from RAID shares to jukebox	None
The RAID share is not on-line	IMPORT - The Image share is not available	Check the permissions on the image share indicated
The <i>src_filename</i> to <i>dest_filename</i> copy failed.	EXPORT - file could not be copied	Check for network connectivity. Check permissions.
The VistA cache file: <i>filename</i> not found	DELETE -Could not find the file on RAID shares to delete	None
This Server is not yet configured!	A BP Server has not been associated with this server.	Create a BP Server for this processor
Unable to copy to the Jukebox: Not enough write cache available	JUKEBOX - The jukebox share is not available or is full	Add new platters to the jukebox. Determine why the jukebox share is full. Possibly add new platters to the jukebox.
Zero size <i>queue_type</i> copy NOT overwritten	Zero size file on the destination could not be overwritten	Remove zero size file

A.2.3 Verifier Application Error Messages

Start/Run

Message	Explanation	Action
About to exit without processing: 0	There are no IEN records within the range.	Choose another IEN range
Broker Connection to server could not be established!	Vista RPC Broker is not currently in a listening state OR the application has timed out.	Close the application and restart. Check with the Vista system manager for the status of the Broker listener.
CC:createcontext ("MAG WINDOWS") could not be established!	The user does not have the MAG WINDOWS menu option assigned.	Assign the user this menu option.
lbCacheShare.items.Count < 1: MAGQ SHARES	There are no online, non-router VMC shares.	Use the Queue Processor's Network Location Manager to check/add the shares.
Invalid Input Range	The From and To values entered in the Range are not correct (e.g. Start: 0 End: 0).	Enter a valid <i>From</i> and <i>To</i> range.
jukebox shares are not setup	The jukebox share(s) are offline or don't exist in the NETWORK LOCATION file (#2005.2).	Create/Edit the jukebox shares in the Network Location Manager on the Queue Processor.
This workstation is not currently setup as a Background Processor.	There is no BP Server set up for this machine.	Use the option <i>BP Servers</i> on the Queue Processor to register this server.
Verifier client software is version nnn. Vista Imaging Host software is version mmm. Please update to compatible client and host software. Shutting down Verifier...	The version of the KIDS file installed on Vista does not match the executable version on the workstation.	Install the latest KIDS and client software.
Vista shares are not setup	The image share(s) are offline or don't exist in the NETWORK LOCATION file (#2005.2).	Create/Edit the shares in the Network Location Manager on the Queue Processor.

Output HTML Messages

Message	Explanation	Action
Aggregate JB Copy Error:	Could not copy from alternate jukebox to current jukebox	Check permissions
Abs to JB:	Abstract has been created and copied to the jukebox	None
Aggregate Function - Enabled	Software is enabled to copy files from secondary jukebox, if necessary	None
BIG Aggregate Failed	Could not copy BIG file from secondary jukebox	Check file existence/permissions
Create Process failed	Could not create process on Vista for Verifier	Check Error Trap

Message	Explanation	Action
Empty FBIG node	"FBIG" node has no pointers set in 2005 record.	Check shares for existence of BIG file. If not found, restore BIG file from backup tapes.
File of size zero created then deleted	Abstract file created of size zero. Then it is deleted. (Likely corruption of BIG and/or TGA file)	None
FULL Aggregate Failed	Could not copy FULL file from secondary jukebox	Check file existence/permissions
FULL Aggregate Failed	Could not copy FULL file from secondary jukebox	Check file existence/permissions
Images JB share is OFF-LINE:	jukebox is offline	Set jukebox back ONLINE
Make AbstractError	Abstract file could not be created from TGA/BIG (BIG/TGA not found or image file corruption).	Check shares for existence of BIG/TGA file. If not found, restore BIG/TGA file from backup tapes.
New Abs to CWL	An abstract file has been created and copied to the current write image share	None
No ABS file VC Ptr Cleared	Abstract file not found on the Image share	None
No ABS file VC Share OFF-Line	Image share is offline at location of abstract file	Set share back online and re-run Verifier
No ABS JB Files	No abstract file found on the jukebox	Check shares for existence of ABS file. If not found, restore ABS file from backup tapes
No Acquisition Site in Image file	The ACQUISITION SITE field #100 in the IMAGE file (#2005) is missing. This is a required field.	Contact IRM Update the field with the proper site ID.
No FULL JB Files	FULL file not found on the jukebox	Check shares for existence of Full file. If not found, restore Full file from backup tapes
No FULL VC Files	FULL file not found on the Image share	None
No jukebox BIG Files	BIG file not found on the jukebox	Check shares for existence of BIG file. If not found, restore BIG file from backup tapes.
No jukebox FULL Files	FULL file not found on the jukebox	Check shares for existence of Full file. If not found, restore Full file from backup tapes.
No Network References	No IMAGE file (#2005) record exists for this image	Re-import image thru the Capture client
No Network References: Archived Image	Image has been archived, resides in the IMAGE AUDIT file (#2005.1)	None
No VC BIG Files	Could not find the BIG file on the image share	None

Message	Explanation	Action
Not Certed	Could not find/create file type on jukebox	Check shares for existence of BIG file. If not found, restore BIG file from backup tapes.
Problem rename log file:	Permission problem with log file	Set WRITE permissions set on share/folder/file for Windows login account.
Text file Patient ID not in VistA	Could not locate patient ID in VistA	Contact IRM
TXT to BIG VC	Copy TXT file to same share as BIG file	None
TXT to FULL VC	Copy TXT file to same share as FULL file	None
"Check Text" Option Messages		
Text File Corruption Error Type 1:	Text file is binary or unreadable	Restore file from jukebox/backup tapes
Cannot determine Text file type:	Foreign text file was not likely generated on the image gateway	Restore file from jukebox/backup tapes
Text File Corruption Error Type 2:	Text file is ASCII but has unprintable characters or truncated	Restore file from jukebox/backup tapes
Text/Image DFN Mismatch:	Patient ID in text file does not match that in VistA	Future utility patch
Text/Image SOP/UID Mismatch	The Series Instance UID in the text file does not match the one in VistA	Future utility patch
Text/Image Study/UID Mismatch	The Study Instance UID in the text file does not match the one in VistA	Future utility patch
Text/Image UID Mismatch	SOP and/or Study UID are/is blank in text file	Future utility patch
Updated Text file	Text file has been edited	Validate file has been copied to the jukebox
No SSN Found	Patient ID field missing in text file	Future utility patch

Integrity Messages on Patient Data

There are integrity issues that will prevent their respective images from being displayed and others that will not impact the viewing. See Appendix C in the *Background Processor User Manual* for sample output.

Conditions Preventing Viewing

An integrity error message will be generated when the image is retrieved for viewing on these conditions and the patient image will not be viewable until the condition is corrected or the user has the proper key to view these images.

Message	Explanation	Action
No Image Ptr in AP	The Clinical Association Report (AP for this image does not contain an image entry that points back to this image.	Future utility patch
GP has no images	Image series that does not contain any images. Group Parents (GP) are containers for an Image series. A group parent with NO group objects (GO) is an invalid condition.	Future utility patch
Conflicting AP & Image DFNs	The patient file reference (DFN) in the Clinical Association Report (AP does not match the DFN in the IMAGE file (#2005).	Future utility patch
Invalid Image Ptr to AP	The Clinical Association Report (AP) has image references that are not in the IMAGE file (#2005).	Future utility patch
Conflicting GP and GO DFN	The patient file reference (DFN) in the Group Parent (GP) is not the same as the DFN in the Image entry.	Future utility patch
GP & GO AP Mismatch	The Group Parent and Group Object pointer references to a Clinical Association Report (AP) do not match.	Future utility patch
GP Missing GO Ptr	The Group Object multiple of the referenced Group Parent does not reference this group object.	Future utility patch
No AP Mult Ptr	This Image entry does not have the clinical application (AP) image multiple entry number specified. The IMAGE file (#2005).record is missing the <i>PARENT DATA FILE IMAGE POINTER</i> (#17) for a Clinical Association Report (AP).	Future utility patch

Appendix A – Error Messages

Message	Explanation	Action
GO DFN mismatches	Some image file Group Objects have different PATIENT references (DFN).	Future utility patch
Image entry is structurally abnormal	The normal structure that distinguishes Image entry Group Parents (GP), Group Objects (GO), and Non-Group image (NG) is corrupt.	Future utility patch
Missing Group Objects	The Group Parent has Group Object references that are missing.	Future utility patch
DFN Mismatches in AP Image Mult	The Clinical Association Report (AP) references a Group Parent that has image files with a different PATIENT reference (DFN) than the report.	Future utility patch

Conditions Allowing Viewing

The following integrity issues will **not** prevent their respective images from being displayed. These are informational messages.

Message	Explanation	Action
No AP Ptr	The IMAGE file (#2005) record is missing the PARENT DATA FILE# (#16) for a Clinical Association Report (AP). This Image does not have the entry in the clinical application (AP) specified.	Future utility patch
No AP entry Ptr	This Image does not have the entry in the clinical application (AP) specified. The IMAGE file (#2005) record is missing the <i>PARENT GLOBAL ROOT DO</i> (#17) for a Clinical Association Report (AP).	Future utility patch

A.2.4 Purge Application Error Messages

Message	Explanation	Action
Broker Reconnection failed	Auto login after a Broker disconnect failed	Check network. Contact IRM
Create Process failed <i>ProgramName</i> ,	Windows failed to create a process.	Reboot the server.
Express Purge Rate limit reached: <i>PurgeRate</i> on share: <i>CurrentShare</i>	The purge terminated on the given share because Express Purge was active and the Purge process exceeded the user defined purge rate.	None
File Delete failure: <i>filename</i>	The file listed could not be deleted.	Check permissions on the share/folder/file
File in use: <i>filename</i>	The log file is in use	Exit from the Purge and restart
File purged: <i>filename</i> . 'The Image file (#2005) was not updated'	The file was deleted on the RAID, but the pointer in VistA could not be updated.	Validate the IEN record exists in VistA.
Findfirst failed <i>filename</i>	The directory traversal failed	Exit from the Purge and restart
Log File Archival reset to: <i>FilePath2</i> instead of: <i>FilePath1</i>	The logs files are now being stored at another location.	None
Login Message^Broker Reconnection Successful	After a Broker disconnect, the application was able to reconnect to VistA.	None
Login Message^Pausing 3 minutes and will then retry	After a Broker disconnect, the application tries 3 times to reconnect to VistA	None
Login Message^Silent Login attempt failed!	After a Broker disconnect, the application was not able to reconnect to VistA.	Check network connections.
NewCreationDate^SetFileTime Failed <i>filename</i>	Could not set the date of last Accesses on filename	None
Non-Connection related Broker error	Broker disconnected	Check VistA for error trap

Message	Explanation	Action
NOT Purged criteria: <i>EvalCriteria</i> NOT PURGED- JUKEBOX QUEUED <i>filename</i> <i>date</i>	File was not deleted. See Section 6.4 Purge Criteria.	None
Problem renaming log file <i>filename1</i> -> <i>filename2</i>	Could not rename log file to versioned log file name	Check permissions.
Purge Criteria: <i>EvalCriteria</i> <i>filename</i> <i>filedate</i>	See Section 6.4 Purge Criteria	None
Purge Criteria: <i>EvalCriteria</i> NOT PURGED <i>filename</i> <i>filedate</i>	File was deleted. See Section 6.4 Purge Criteria	None
Silent Login attempt	Broker was disconnected. Auto login is initiated.	None
Start Date failure	Problem with Date of Last Purge on Scheduled Purge	Contact IRM to clear the record in the Imaging Site Parameter file.

A.3 DICOM Gateway Error Messages

Information about DICOM Gateway Error messages is available in the *Imaging System Error Message Guide*.

A.4 Clinical Display/Capture Setup Error Messages

The following errors are possible during the MAGINSTALL.EXE file execution. When the MAGINSTALL file is transported via FTP, it should be in binary format (or possible file corruption may occur).

Error Message	Notes
Incorrect Windows version.	Review the installation manual regarding the application's Windows compatibility.
Invalid executable file.	Possible corrupted MAGINSTALL.EXE file.
Type of executable file was unknown.	Possible corrupted MAGINSTALL.EXE file.
Attempt was made to load a second instance of an executable file	Possible corrupted MAGINSTALL.EXE file.

Error Message	Notes
containing multiple data segments that were not marked for read-only.	
Dynamic Link Library (DLL) file was invalid.	One of the DLLs required to run this application was corrupt.
[2] Imaging Display	The Imaging Display application is open. Close the application and click retry.
[1] Imaging Capture	The Imaging Capture application is open. Close the application and click retry.

A.5 VistARad Error Messages

Error messages associated with the VistARad application are listed below. Messages are listed alphabetically. This list is not exhaustive. It omits some messages which are informational, supply their own remediation instruction, or are otherwise self-evident. If a message not on this list appears and requires further explanation, please contact the National Help Desk.

Error Message	Cause(s)/Solutions
Case #nnn is already locked by you, perhaps at another workstation.	A user has attempted to lock an exam that is already locked in their name. This could occur from two different logons from different workstations; or, it could result from a failed connection that left an process hanging without a connected client.
Case %s: all images failed to load.	No images for the selected case could be found. If any valid headers are located, one or more “dummy” thumbnails may be displayed in the Preview window, but no actual images are available. Close the exam, then attempt to re-open it. If the problem persists, contact the local Imaging Coordinator.
Case #nnn is Locked by [Name/Unknown]; Status Update will NOT be allowed.	Between the time that the exam was opened and locked, and the time the exam was closed for update, the Exam lock information had changed, making the exam not updateable. If this occurs, check for problems in the lock table or with the Broker connection.

Error Message	Cause(s)/Solutions
Case #nnn locked by [name], not locked by [user]--No Status update performed	Between the time that the exam was opened and locked, and the time the exam was closed for update, the lock information either was killed, or over-written with another user's information.
Case #nnn was previously locked by [Radiologist]. The lock is now assigned to you.	The radiologist that previously had the lock likely had the M session abnormally terminated.
Case %s: no valid headers found.	<p>Images in the exam do not have valid headers and cannot be processed properly. The exam load is considered successful.</p> <p>You can display images by loading the "IMG_INVALID_TEXT" stack in the Preview window into the Viewer; the exam can be locked for interpretation.</p>
Case %s: some image(s) are missing.	<p>Some images and/or headers could not be found. The exam load is considered incomplete. Depending on what is missing, one or more placeholders will be used in the Preview and Viewer windows. The exam cannot be locked or interpreted.</p> <p>Close the exam, then attempt to re-open it. If the problem persists, contact the local Imaging Coordinator.</p>
Case %s: some image(s) have invalid or missing headers.	<p>The headers for some images in the case could not be found. Images that can be processed properly will be displayed normally; images that could not be processed due to missing header data will be loaded into the Preview window only with an "IMG_INVALID_TEXT" label.</p> <p>The exam can be locked and interpreted.</p>
Case with number xxx will not be loaded, Error 0x %x.	A VistARad internal error occurred while opening the exam.
Could not send files to MIRC Server at <Host Name> and Port <Port Number> with AE Title <AE Title>.	Ensure that the MIRC server configuration information is correct, that the MIRC server is online, and that it can receive messages.

Error Message	Cause(s)/Solutions
Current Case Not Accessible for Updating	A user request to close an exam cannot be processed because the data does not have valid information that correctly identifies a Radiology study. Check the exam data stored in the Radiology database.
Current Case not accessible to close--no action taken	A user request to close an exam cannot be processed because the data does not have valid information for the Radiology study. Check the exam data stored in the Radiology database.
Don't know how to read this image element.	An unexpected value was found in the last DICOM tag listed in the Viewport Info tab of the Hanging Protocol Definition dialog. The hanging protocol definition cannot be saved. Verify that the image header is populated properly for the DICOM tag in question.
Error getting shared CPT-HP association info.	VistARad was unable to read information from the VistA host. Check the VistA error trap & contact your Imaging Coordinator or the National Help Desk.
Error Initializing HP module.	VistARad was unable to read information from the VistA host. Check the VistA error trap & contact your Imaging Coordinator or the National Help Desk.
Error occurred while performing search.	The VistARad client was not able to contact the VistARad host. Check for status details at the bottom of the manager window.
Error Reading File MAGJ.INI	MAGJ.INI not present in expected location (C:\Program Files\Vista\Imaging\MAG_VistARad). The software will start, but users will not be able to display local copies of routed exams or use integrated voice dictation functions until the problem is resolved.
Error reading settings. VistARad will exit.	The client was unable to retrieve monitor information from the VistARad back end on the VistA Host. Verify that the VistA Host is accessible and running.

Error Message	Cause(s)/Solutions
Error retrieving monitor information (Error:%d). VistARad will exit.	The VistARad client could not retrieve monitor information stored on the VistARad back end. System queried back end for monitor information but gets no response. Verify that a connection is present and that the VistA system is up and running.
Exam is for Station (nnn); you are logged on to #mmm". Exam is NOT Locked.	The exam being opened is exam registered at a consolidated site that is a not the user's logon site (division). The exam can be displayed but its status cannot be updated.
Exam Manager failed to Initialize. VistARad will exit.	The client was unable contact VistARad back end on the VistA Host. Verify that the VistA Host is accessible and running, and that the correct KIDS version is installed.
Exam Status for Case #nnn CANNOT be updated; current status remains: [Status]	<p>The status update cannot proceed because there is insufficient information in the radiology record to allow the status to advance.</p> <p>If this occurs frequently, then the site has not properly performed VistARad system setup regarding Radiology Exam Status codes definition—refer to Chapter 3 in the <i>VistA Imaging Installation Guide</i>.</p>
Failed to get HP info from the backend for default system user. Error code 0x80004005.	VistARad was unable to read information from the VistA host. Check the VistA error trap & contact your Imaging Coordinator or the National Help Desk.
Failed to import user profile. Click OK to exit VistARad.	VistARad was unable to read information from the VistA host. Check the VistA error trap & contact your Imaging Coordinator or the National Help Desk.
Failed to read in xxx preset definition of the current or system user correctly.	There was a problem processing the specified image preset definition. Do not use the specified image preset until the problem is resolved.

Error Message	Cause(s)/Solutions
Failed to read in xxx template definition of the current or system user correctly.	There was a problem processing the specified template definition. Do not use the specified template until the problem is resolved.
Failed to retrieve a preset xxx for user xxx	There was a problem retrieving preset information from the VistARad back end. Verify that a connection is present and that the VistA system is up and running.
For Case #nnn, current Status is [status]; Status Update will NOT be allowed	Between the time the exam list indicated an exam was lockable and the time the exam was opened, the exam status had changed, making the exam not lockable. If this happens frequently, exam list compile intervals specified in the MAG VISTARAD SITE PARAMETERS file (#2006.69) may need to be adjusted.
For MAGJ STUDYDATA (TX="_TXID_") invalid params passed to rpc call.	Invalid request for key image and/or presentation state data was received on the VistA host; could indicate a database problem with the exam or images in the exam being looked at.
HP creation failed, error code xxxx	An application error prevented creation of the hanging protocol; record the error code and contact Customer Support.
HP named xxx could not be read in correctly.	There was a problem processing the specified hanging protocol definition. Do not use the specified hanging protocol until the problem is resolved.
Insufficient memory; cannot load all text files, thumbnails and/or key images. Load aborted for case(s) XXX.	Exit and restart VistARad to clear any potential memory issues. Attempt to reload the exam in question. Contact your Imaging Coordinator if the error persists.
Invalid Request (ListType=xxx)	An attempt to compile an exam list failed. The exam list definition in MAG RAD LISTS DEFINITION file (#2006.631) may be corrupted. The exam list definition should be fixed or disabled.

Error Message	Cause(s)/Solutions
Invalid transaction (TX="_TXID_") requested by MAGJ STUDYDATA RPC call.	Invalid request for key image and/or presentation state data was received on the VistA host; could indicate a database problem with the exam or images in the exam being looked at.
Modality type xxx not found in the configuration file.	hpconfig.xml does not contain information for the modality associated with the active exam. Verify that modality for the exam in question is being correctly identified and that hpconfig.xml file stored in the VistARad application folder is present and not corrupt.
Modality xxx not found. Please contact your system administrator"	The hpconfig.xml file does not contain information for the modality associated with the active exam. Verify that modality for the exam in question is being correctly identified and that hpconfig.xml file stored in the VistARad application folder is present and not corrupt.
No data supplied for History List update/delete.	The client software performed an invalid request to update the History list.
No modality in this stack of images	The exam being opened does not contain modality information.
No Update Allowed for Case #nnn--current status is [Status]	Between the time that the exam was opened and locked, and the time the exam was closed for update, the Exam Status information had changed, making the exam not updateable. This can occur if a data entry operation was performed in Radiology package while the exam was being read.
<p>Image loading has been paused: not enough memory to load all images at once.</p> <p>Use the Preview window's List view mode to load and/or purge selected image sets.</p>	Using the Preview window in List View mode, click "Purge" on one or more (partially) loaded series to free their memory. Then click "Resume" on the series of interest that was paused.

Error Message	Cause(s)/Solutions
Request Contains Invalid Case Pointer (nnn^nnn^nnn^nnn).	A user request to open an exam cannot be processed because the data does not have valid information that correctly identifies a Radiology study. Check the exam data stored in the Radiology database.
Resource limit exceeded! Close some images	The maximum number of DIMPLX controls allowed by the operating system has been exceeded. Use the layout controls in VistARad to reduce the number of visible viewports.
<p>Startup problem: cannot launch background case loader.</p> <p>Startup problem: cannot launch background cleaner.</p> <p>Startup problem: cannot create image load/display objects.</p>	Exit and restart VistARad; contact customer support if this error persists.
The current History List may not be updated by the current user.	The client software performed an invalid request to update the History list.
The Exam file for this exam has patient [Pat1]; the corresponding Report file has patient [Pat2]. This is a serious problem—immediately report it to Radiology management and Imaging support!	The exam failed a “Patient Safety” check.
This exam has no report entry for associating images; no images can be accessed.	There is no Radiology Report link for the images in the exam being opened. Could be normal; or, a database problem (e.g., induced by deleting a Report without first correcting images).
This exam has problems in the Radiology files, with two different Case Numbers referenced Ref1 and Ref2. This is a potentially serious problem—immediately report it to Radiology management and Imaging support staff!	The exam failed a “Patient Safety” check.

Error Message	Cause(s)/Solutions
<p>This exam has problems in the Radiology Report file, with two different report entries referenced Ref1 and Ref2. This is a potentially serious problem--immediately report it to Radiology management and Imaging support staff!</p>	<p>The exam failed a “Patient Safety” check.</p>
<p>This exam is linked to Report entry #nnn, but some of its images may be linked to Report entry #mmm. This is a potentially serious problem--immediately report it to Radiology management and Imaging support staff!</p>	<p>The exam failed a “Patient Safety” check.</p>
<p>This exam is registered for [Pat1]; however, it is linked to images for patient [Pat2]. This is a serious problem--immediately report it to Radiology management and Imaging support staff!</p>	<p>The exam failed a “Patient Safety” check.</p>
<p>The resolution of the display is not suitable for displaying diagnostic quality images. VistARad will exit.</p>	<p>This message appears if monitor resolution width is less than 1024, or if monitor resolution height is less than 700, or if monitor bit depth is less than 8.</p>
<p>Unable to access HISTORY File for deleting records; try again later.</p>	<p>A delete or other update operation cannot be performed because the current M process cannot lock the file for the user.</p>
<p>Unable to connect to specified host/port or Unable to obtain VIX connection information for the specified Site code</p>	<p>VistARad cannot establish a connection to the specified remote VIX server. Verify correct data entry. If necessary, consult your local ADPAC to confirm that the specified VIX server is on-line and the Site Service is configured properly.</p>
<p>Unable to get/update user data (USER_name) for MAGJ USER DATA RPC call.</p>	<p>The system could not retrieve data from the MAGJ USER DATA file (#2006.68).</p>

Error Message	Cause(s)/Solutions
Unable to open device 'IMAGING WORKSTATION'	<p>Attempt to display a VistARad report fails because the host system cannot open the device for host file output.</p> <p>Fix the device file entry.</p>
Unable to retrieve images for Case #nnn	Probably a database problem; the system expected to find images, but did not find any.
Unable to update Interpreting Radiologist:[Explanation provided]	The Status Update cannot proceed because the user fails Radiology package user security checks.
Update failed	There was a problem saving preset information to the VistARad back end. Verify that a connection is present and that the VistA system is up and running.
Updates not allowed at this site--no action taken	After the exam was closed and locked, the back end “Enable Status Update” setting has been disabled.
VistARad cannot run in a terminal services client environment. VistARad will exit.	VistARad cannot be launched using a remote desktop connection or terminal services client.
VistARad is already running. Exiting application.	Another instance of VistARad is running on the workstation. If that instance cannot be accessed from the Windows Taskbar, you may need to kill the process named “VistARad Viewer” using the Windows Task Manager; you may need to end the MAG_Vistarad.exe process from within the Processes tab of the Windows Task Manager. Then re-launch VistARad.

Appendix A – Error Messages

Appendix B Means Tests

B.1 Sending Means Tests to the HEC

The following is the current list of 'Image Types' that need to be sent to the HEC (Health Eligibility Center):

- MEANS TEST (10-10EZ)
- MEANS TEST (10-10EZR)*
- MEANS TEST (10-10F)

* The (HEC) has requested that a third type of Means Test (EZR) be copied to them. Sites need to add the MEANS TEST (10-10EZR) Image Index Type to the IMAGE ACTIONS file (#2005.86) to allow the transfer of this type of Means Test.

- A qualified person at the site needs to use FileMan to edit the IMAGE ACTIONS file (#2005.86); select the TYPE field (#5); and choose HEC COPY at the Image Action name field prompt.
- You can also log a Remedy ticket and have VistA Support guide you through this process.

An example of adding a new Index Type to be sent to HEC is shown below. User entries are shown in **bold**.

```
D P^DI
VA FileMan 22.0
Select OPTION: ENTER OR EDIT FILE ENTRIES

INPUT TO WHAT FILE: IMAGE ACTIONS
EDIT WHICH FIELD: ALL// TYPE (multiple)
EDIT WHICH TYPE SUB-FIELD: ALL// <ENTER>
THEN EDIT FIELD: <ENTER>

Select IMAGE ACTIONS NAME: HEC COPY
Select TYPE: MEANS TEST (10-10F)// ? <ENTER> or type two question marks and press <ENTER>
Answer with TYPE
Choose from:
MEANS TEST (10-10EZ)
MEANS TEST (10-10F)
You may enter a new TYPE, if you wish
Answer with IMAGE INDEX FOR TYPES NAME, or CLASS
Do you want the entire 57-Entry IMAGE INDEX FOR TYPES List? Yes <ENTER>

Choose from:
List has been shortened for this example

ADVANCE DIRECTIVE
BILLS
COMMITMENT
DD214 ENLISTED RECORD & RPT OF SEP
ELIGIBILITY/VA FORM 10-7131
FINANCIAL WORKSHEET
HEALTH INSURANCE CARDS
IMAGE
```

Appendix B – Means Tests

```
LEGAL DOCUMENTS
MEANS TEST (10-10EC)
MEANS TEST (10-10EZ)
MEANS TEST (10-10EZR)
MEANS TEST (10-10F)
MEDICAL CERTIFICATE

Select TYPE: MEANS TEST (10-10F)// MEANS TEST
  1 MEANS TEST (10-10EZ)
  2 MEANS TEST (10-10F)
CHOOSE 1-2: <ENTER>
  1 MEANS TEST (10-10EC)
  2 MEANS TEST (10-10EZ)
  3 MEANS TEST (10-10EZR)
  4 MEANS TEST (10-10F)
CHOOSE 1-4: 3 MEANS TEST (10-10EZR)
Are you adding 'MEANS TEST (10-10EZR)' as a new TYPE (the 3RD for this IMAGE ACTIONS)? No//
Yes
Select TYPE: <ENTER>

Select IMAGE ACTIONS NAME: <ENTER>

To check the new file entry:

Select OPTION: INQUIRE TO FILE ENTRIES

OUTPUT FROM WHAT FILE: IMAGE ACTIONS// <ENTER>
Select IMAGE ACTIONS NAME: HEC COPY
ANOTHER ONE: <ENTER>
STANDARD CAPTIONED OUTPUT? Yes// <ENTER>
Include COMPUTED fields: (N/Y/R/B): NO// <ENTER>
  - No record number (IEN), no Computed Fields

NAME: HEC COPY                ACTIVE: NO
TAG: HEC                      ROUTINE: MAGGSPP
DESC: Means Test document images will be copied to the Health Eligibility Center (HEC)
TYPE: MEANS TEST (10-10EZ)
TYPE: MEANS TEST (10-10F)
TYPE: MEANS TEST (10-10EZR)

Select IMAGE ACTIONS NAME: <ENTER>
```

Note: Sites would only want to add/expand on what gets sent to the Health Eligibility Center (HEC) upon a direct request from the Health Eligibility Center (HEC) to do so. This is usually a rare occurrence, and all sites will be notified if this occurs.

Glossary

Annotation	The ability to attach notes to images.
Architecture	The design of the components of a computer, network, or software system.
Archive	The long-term storage of data or images.
Audit trail	Record of activity on a particular file or computer.
Background processing	Simultaneous running of a "job" on a computer while working on another job. Examples would be printing one document while working on another, or the software may do automatic saves while you are working on something else.
Brightness	The balance of light and dark shades in an image.
Composite video	TV signal that sends color, vertical and horizontal signals together.
Contrast	Range between the lightest and darkest tones in an image.
DHCP	D ecentralized H ealth C are P rogram (obsolete meaning)
DHCP	D ynamic H ost C onfiguration P rotocol (current meaning)
DICOM	D igital I maging and C ommunications in M edicine. A medical imaging standard, DICOM is standard for Radiology equipment and is being adopted by the other members of the medical imaging community.
Digital camera	A camera that transforms a picture into a system of numbers. The picture can then be manipulated pixel (dot) by pixel, and stored and transmitted as a file.
File protection	Techniques for preventing files from being erased.
File server	A machine where shared software and data files are stored.
Frame grabber	A device that translates a frame from a video image into a still digitized image.
Gray scale	The range of shades of black in an image. The more shades recognized by the device, the clearer and sharper the image will be.

Glossary

High resolution	An image or a display that has more pixels per inch than a conventional display/
Image	The computerized representation of a picture, or graphic.
Image abstract	A "thumbnail" version of an image, which requires less computer processing resources to display than the actual image.
Image group	A group of images associated with a medical examination.
Image processing	The translation of an image into a digital computer language so that it may be manipulated in size, color, clarity, or to enhance portions of it.
Image resolution	The fineness or coarseness of an image.
Imaging system	Collection of units that work together to capture and recreate images.
Jukebox	A device that holds multiple optical discs and can swap them in and out of the drive as needed.
Level	The pixel value (brightness) of a greyscale image that is displayed at 50% brightness.
Multimedia	Combining more than one media for the dissemination of information (i.e., text, graphics, full video motion, audio).
Off-line	Something that is not available for access on the system.
Online	Something that is available for access on the system.
Optical disc	A direct access storage device that is written to and read by laser light. Optical discs can store more data per unit of surface area than magnetic media. Many optical discs are Write Once Read Many (WORM).
Pan	To view different parts of the image that extend beyond the borders of the screen by moving the image.
Pixel	The individual dots that define a picture.
Resolution	Measure of output quality (dpi—dots per inch) or halftone quality (lpi—lines per inch).
Retrieval	The ability to search for, select, and display a document or image from storage.

RGB	Red, Green, Blue. The colors used in varying combinations and intensities on monitors, TV screens, and other color displays.
Scanner	A device that converts a hardcopy image into machine-readable code.
Server	A computer that is dedicated to one task.
Storage media	The physical device onto which data is recorded.
TWAIN	An interface standard for scanners, cameras and other input devices. A TWAIN driver is generally supplied by the equipment vendor.
User preferences	The preferences that each user sets in the User Preferences window that control the circumstances and ways in which the Imaging package displays images.
Video camera	Camera that records full-motion video.
Video digitizer	A device that changes a video picture into a digital computer language.
VistA	<u>V</u> eterans Health <u>I</u> nformation <u>S</u> ystem <u>T</u> echnology <u>A</u> rchitecture. VistA replaces DHCP.
VistA Magnetic Cache (VMC)	The files servers' setup as shares in the NETWORK LOCATION file (#2005.2) for newly captured and recently access clinical images.
Window	A rectangular area on a screen (sometimes within another window) that contains controls, such as drop-down boxes, icons, scroll-bars and/or buttons.
Workstation	A high-powered machine for a single user, typically used for computer-aided design or complex analysis.
Write Once Read Many (WORM)	Once written to the disc, data is only available for reading and cannot be altered.
WYSIWYG	"What you see is what you get." The feature of seeing images and text exactly as they will look when printed or transmitted.
Zoom	To enlarge an image or a portion of an image.

Index

- %**
 - % Server Reserve, 104
- A**
 - ad hoc reporting, 137
 - ADPAC staff requirements, 25
 - ADT protocols, 151
 - archiving, 77
 - Auto-Write function, 104
- B**
 - Background Processor
 - configuration guidelines, 84
 - files installed on, 43
 - overview, 2
 - BackProc.log file, 81, 82
 - backward compatibility, 149
 - biomedical staff requirements, 25
- C**
 - CCOW communication, 126
 - Check text files, 103
 - Clinical Workstation
 - files installed on, 38
 - CONFIGURE IHE-BASED HL7 ADT
 - INTERFACE TO PACS menu option, 69
- D**
 - DFNError log file, 83
 - DICOM error log, 113
 - DICOM Gateway, 107
 - and PACS, 149
 - HL7 messages and, 121
 - RPC calls, 123
 - DICOM overview, 2
 - DICOM_Echo, 24
 - document counts report, 138
 - drag, 9
- E**
 - error log
 - DICOM, 113
 - MSM, 113
 - error messages, 167
 - Error messages, 193
 - event viewer, 24, 26
 - exported options, 67
- F**
 - failed images, processing, 112
 - file migration, 108
 - file security, 64
 - FileMan files, 55
- G**
 - global journaling, 66
- H**
 - hardware maintenance, 19
 - HEC, sending means tests to, 203
 - HL7 application parameters, 121
 - HL7 logical link, 121
 - HL7 MESSAGE TEXT file (#772), 161
 - HL7 messages, 121
 - HL7 protocols
 - Radiology v.2.1, 149
 - Radiology v.2.4, 150
- I**
 - ICRs (integration control registrations), 125
 - Image Cache, 127
 - image count by user report, 138
 - IMAGE file (#2005)
 - deletion, 77
 - migration, 77
 - IMAGE file (#2005)
 - archiving or purging, 77
 - images

- taking offline, 108
- viewing remotely, 165
- IMAGING HL7 MESSAGING MAINTENANCE, 68
- Imaging package requirements, 11
- Imaging Site parameters, 96
- Imaging system
 - general maintenance, 26
 - overview, 1
 - RPC calls, 122
- Import API, 116
- input templates, 63
- Internal Relations, 149
- IRM staff requirements, 24

J

- journaling, 66
- jukebox backups, 107

L

- Log files
 - Background Processor, 80
 - BackProc.log, 81, 82
 - DFNError log, 83
 - NoArchive log, 82
 - Purge.html log, 83
 - PurgeError.html log, 83
 - Queue Processor, 81
 - Scan log, 82
 - ScanError log, 83
 - Verifier log files, 82

M

- MAG CLIENT VERSION REPORT menu
 - option, 71
- MAG CPACS, 121
- MAG HL7 MAINT menu option, 68
- MAG REASON EDIT menu option, 70
- MAG SERVER mail group, 126, 127
- MAG_Decompressor, 53
- MAGD MAINT RAD HL7 SUBS menu
 - option, 68
- MAGREPSTART, 136
- MailMan messages, 126

- MAINTAIN SUBSCRIPTIONS TO RADIOLOGY HL7 DRIVERS menu
 - option, 68
- maintenance
 - general, 26
 - hardware, 19
 - security software, 21
- means test report, 142
- means tests, 203
- Menus
 - Imaging System Manager, 67
 - VistARad System Options, 72
- messages
 - HL7, 121
 - Image Cache, 127
 - MailMan, 126
 - site usage, 127
 - Windows, 125
- Microsoft patches, installing, 19
- modalities, changes to, 19
- mouse, 8
- MSM error log, 113

N

- Network Location Manager, using, 94
- network resources, 23
- NoArchive log file, 82

O

- offline images, 108
- online help, 159

P

- package index contains 'note' report, 142
- package requirements, 11
- package-wide variables, 157
- patches, Microsoft, installing, 19
- patient movement protocol, 153
- ping, 24
- power requirements, 24
- processing failed images, 112
- productivity reports, 137
- protocols
 - patient movement, 153

- radiology, 149, 153
- Purge configuration, 89
- Purge log files, 83
- Purge.html log file, 83
- PurgeError.html log file, 83
- purging, 77, 78

- image shares, 110
 - message files, 112
 - modality worklist, 112
 - PACS messages, 112

Q

- Queue Processor overview, 2

R

- Radiology HL7 v2.1 protocols, 149
- Radiology HL7 v2.4 protocols, 150
- radiology protocols
 - DICOM, 149
 - VistARad, 153
- radiology report transcription service, 161
- RAID Group Advance, 104
- reboot, 7
- remote access requirements, 24
- Remote Image Views, 165
- reports, imaging site, 137
- routines
 - non-M, 37
- RPC calls
 - DICOM Gateway, 123
 - VistA Imaging, 122

S

- Scan log file, 82
- ScanError log file, 83

- Scheduled Verifier, 102
- security, 21
 - file, 64
- security keys, 14
- server manager, 24
- site parameters, 12
- site parameters for Imaging, 96
- site usage messages, 127
- space requirements, 23
- staff requirements
 - ADPAC, 25
 - biomedical, 25
 - IRM, 24
- system outages, 66

T

- TraceRT, 24

U

- user manager, 24

V

- Verifier overview, 2
- Verifier, using, 106
- VistA Imaging ADT protocols, 151
- VistA Site Service, 14, 147, 166
- VIX, 4, 23, 53, 113, 147

W

- window controls, 8
- Windows messaging, 125
- Windows servers, changes to, 19
- Workstations, 7