

# **Bed Management Solution (BMS)**

## **Technical Manual**



**November 2016**

## Revision History

Creation Date	Version No.	Description/Comments	Author(s)	Reviewer(s)	Review Type	Issue Date
11/29/2016	0.9	Updated for December 2016 Release, added section "CA SiteMinder Web Agent" installation	D.Horn			
11/2/2016	0.8	Updated document for Public VDA Portal, 508 compliance and removed real servernames and url addresses.	D.Horn			
8/5/2016	0.7	Updated document for BMS v2.0: Updates to Figure 1 Diagram, SQL Server version, ASP.NET, MVC.	D.Horn			8/12/2016
3/4/2016	0.6	Removed real URL and server addresses and replaced them with generic address names throughout the document	H. Gau			3/4/2016
7/15/2015	0.5	Final team review	P. O'Reilly, N. Morrison, H. Gau, A. Ray, B. Welkder, L. Harth			7/15/15
06/05/2015	0.5	Technical edit. Fix issues with table of tables and table of figures.	R. Wilder			06/30/2015

Creation Date	Version No.	Description/Comments	Author(s)	Reviewer(s)	Review Type	Issue Date
6/05/2015	0.5	<p>Updated the following sections:</p> <p>2.2 System Requirements</p> <p>2.3 Configuration Parameters</p> <p>2.4 Scheduled Windows and SQL Jobs Configuration</p> <p>2.4.1 BMS Reports Full</p> <p>2.4.2 BMS Incremental</p> <p>2.4.3 BMS Reports WMI</p> <p>2.5 Ward Whiteboard Kiosk Setup</p> <p>2.6 Whiteboard Snapshot Configuration</p> <p>2.7 EMS Mobile Defice Configuration</p> <p>2.9 NUMI Integration</p> <p>3.3 Database Architecture</p> <p>3.4 Component Files</p> <p>7 Software Security</p>	P. O'Reilly, N. Morrison, H. Gau, A. Ray, B. Welkder, L. Harth			6/30/2015
07/17/2013	0.4	<p>Updated section 2.3 Configuration Parameters,</p> <p>updated section 2.5 Whiteboard Kiosk Mode,</p> <p>updated section 2.7 EMS Mobile Device Configuration,</p> <p>added Appendix 9.5,</p>	S. Greenacre			07/19/2013
07/29/2013	0.3	<p>Updated section 2.8.1.1 to include the MDWS Endpoint.</p>	S. Greenacre			08/06/2013

Creation Date	Version No.	Description/Comments	Author(s)	Reviewer(s)	Review Type	Issue Date
10/07/2013	0.2	Updated section 2.2 with service account information, Renamed and Updated section 2.6.3, Added a note to section 2.6.4, added log files to section 8.	S. Greenacre			10/15/2013
06/12/2013	0.1	Initial baseline.	S. Greenacre			07/09/2013

# Table of Contents

<b>Bed Management Solution (BMS)</b> .....	<b>1</b>
Technical Manual.....	1
Revision History .....	2
Table of Contents.....	5
List of Figures .....	10
<b>1 Introduction</b> .....	<b>12</b>
1.1 Purpose .....	12
1.2 BMS Overview.....	12
1.3 References.....	12
<b>2 Implementation and Maintenance</b> .....	<b>13</b>
2.1 BMS Infrastructure Diagram .....	13
2.2 System Requirements (Hardware and Software).....	14
2.3 Configuration Parameters.....	16
2.4 Scheduled Windows and SQL Jobs Configuration.....	103
2.4.1 BMS Reports Full.....	103

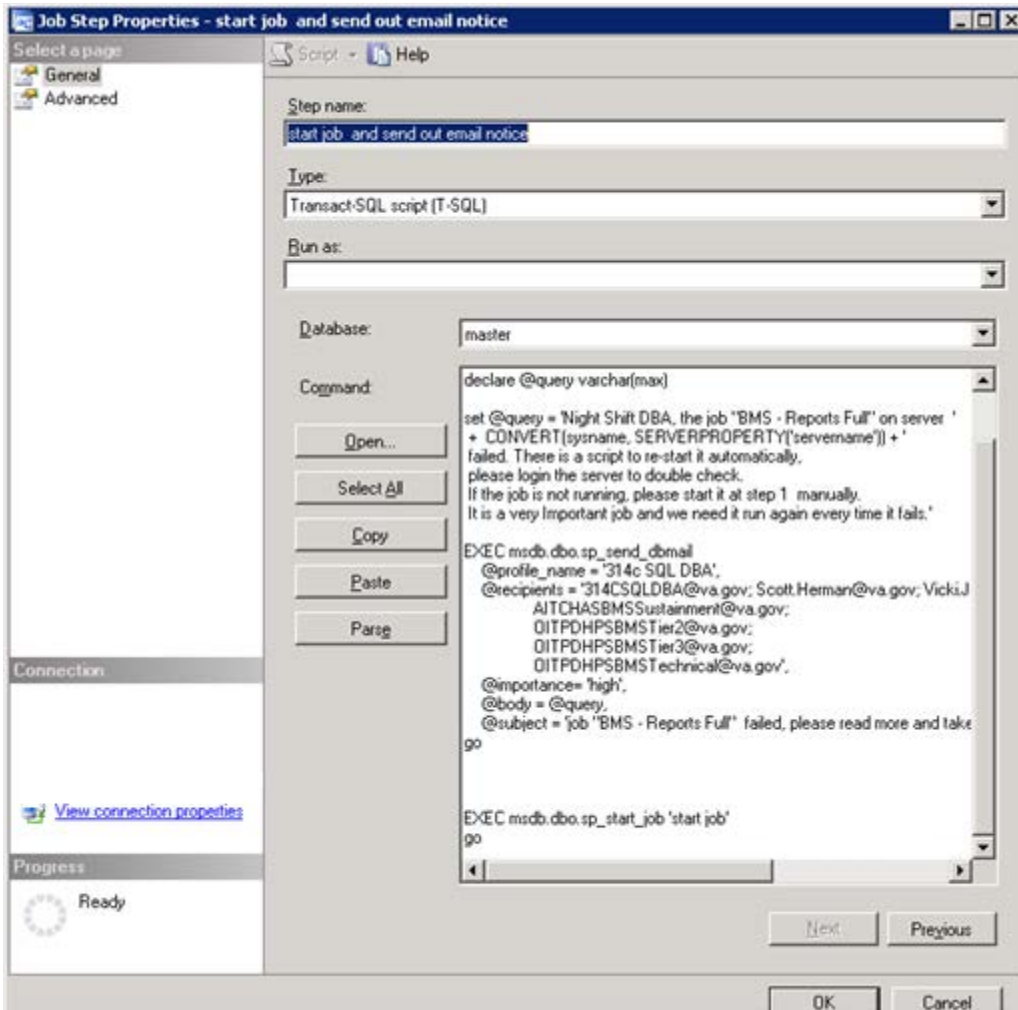

2.4.2	Incremental.....	113
2.4.3	BMS Reports Windows Management Instrumentation (WMI).....	120
2.5	Ward Whiteboard Kiosk Mode Display Configuration (BMS Whiteboard Kiosk Setup)	121
2.5.1	Create the Ward Whiteboard Kiosk URL .....	123
2.5.2	Set up a default user for the BMS Kiosk .....	124
2.5.3	Set up the Workstation / Kiosk Machine .....	126
2.6	Whiteboard Snapshot Configuration .....	137
2.6.1	Create Snapshot Folder.....	137
2.6.2	Define Network Share.....	138
2.6.3	Assign Rights to Master BMS Service Account User .....	140
2.6.4	Assign Snapshot Folder Path to Ward Group .....	146
2.6.5	Associate Scheduler with Whiteboard Report .....	147
2.7	EMS Mobile Device Configuration .....	148
2.7.1	Configure EMS Mobile Device Default Login User.....	148
2.7.2	Configure EMS Mobile Device URL .....	150
2.8	VistA Integration .....	150
2.8.1	Choose VistA Site.....	151

2.8.2	Define Schedulers .....	152
2.8.3	Run Scheduler .....	153
2.8.4	View Audit Results .....	154
2.9	NUMI Integration .....	155
	Integration Settings .....	156
2.9.1	Choose VistA Site .....	156
2.9.2	Define Schedulers .....	156
2.9.3	Select Scheduler.....	156
<b>3</b>	<b>Application structure .....</b>	<b>157</b>
3.1	Application Components.....	157
3.2	Application Directory Structure .....	158
3.3	Database Architecture .....	159
3.4	Component Files .....	159
<b>4</b>	<b>Archiving .....</b>	<b>184</b>
<b>5</b>	<b>External Relationships .....</b>	<b>185</b>
<b>6</b>	<b>External Interfaces .....</b>	<b>186</b>
<b>7</b>	<b>Software Security.....</b>	<b>187</b>
7.1	Policy Manager.....	189
7.2	Operation Definitions .....	189
7.3	Task Definitions .....	200
7.4	Role Definitions .....	210
7.5	Assigning a Role to a User .....	211
7.6	Adding a New Role.....	212
7.7	Adding a New Task.....	214
7.8	Adding a New Operation .....	216
7.9	Business scenarios and use cases .....	217
<b>8</b>	<b>CA SiteMinder Web Agent (SSO) Installation .....</b>	<b>219</b>
<b>9</b>	<b>Detailed Functional Model on Each Interface .....</b>	<b>236</b>
9.1	Service contracts .....	236
	Data contracts .....	240
9.2	BMS Roles .....	240
<b>9</b>	<b>Troubleshooting .....</b>	<b>241</b>
<b>10</b>	<b>Appendix A – BMS Diagrams.....</b>	<b>247</b>
10.1	Business Process Diagrams.....	247
10.2	Activity Diagram .....	252

10.3 Functional Flow Diagram..... 252

**1.1 10 Appendix B - Terms, Acronyms, and Abbreviations .....255**



## List of Tables

Table 1: Server for Web Applications .....	14
Table 2: Application Sever .....	14
Table 3: Database Server .....	15
Table 4: BMS ServiceHost Configuration Parameters.....	16
Table 5: EIS Service Configuration Parameters .....	81
Table 6 - EVS Service Configuration Parameters.....	84
Table 7 - PAP Service Configuration Parameters .....	88
Table 8 - PDP Service Configuration Parameters .....	91
Table 9 - RS Service Configuration Parameters.....	92
Table 10 - STS Service Configuration Parameters .....	93
Table 11 - Win ServiceHost Configuration Parameters.....	96
Table 12 - WMI User Group Configuration Parameters.....	97
Table 13 - Policy Manager Configuration Parameters .....	97
Table 14 - BMS Web Configuration Parameters .....	98
Table 1 - Ward Whiteboard URL Configuration Parameters .....	123
Table 16: Facility Settings Page Parameters .....	149
Table 17: BMS Admin Page Parameters .....	149
Table 18: Description and Configuration for EMS Mobile Device URL parameters .....	150
Table 19: New VistA Site Parameters .....	152
Table 20: New Scheduler Parameters.....	153
Table 21: View Audit Results Columns Report.....	155
Table 22: BMS Database Files .....	159
Table 23: BMS Service Files.....	161
Table 24: Win Service Host Files .....	165
Table 25: BMS Web Site Files.....	174
Table 26: PolicyManager Files.....	183
Table 29: Terms, Acronyms, and Abbreviations .....	255

## List of Figures

Figure 1: BMS Infrastructure Diagram .....	13
Figure 17 - BMS Ward Whiteboard Screen .....	121
Figure 18 - Facility Settings .....	125
Figure 19 - Whiteboard Kiosk User Role Assignment Fields Filled in on the BMS Admin Section Add/Edit BMS User Page .....	126
Figure 20 - Screen Saver Option.....	127
Figure 21 - Screen Saver Settings Window .....	128
Figure 22 - Power Options .....	129
Figure 23 - Change Plan Settings Option.....	129
Figure 24 - Power Options Settings.....	130
Figure 25 - Run Window.....	131
Figure 26 - Run Window with Command Entered .....	131
Figure 27 - User Accounts Window.....	132
Figure 28 - User must enter a user name and password to use this computer option.....	133
Figure 29 - Tools Menu of Internet Explorer.....	134
Figure 30 - General Tab of Internet Options.....	135
Figure 31 - Open Option .....	135
Figure 32 - Internet Explorer Shortcut.....	136
Figure 33 - Windows Registry Editor.....	137
Figure 34: Whiteboard Snapshot Folder .....	138
Figure 35: Whiteboard Snapshot Folder Properties .....	139
Figure 36: Advanced Sharing Option .....	139
Figure 37: Share this folder Option.....	140
Figure 38: Permissions for Whiteboard Snapshot .....	141
Figure 39: Select Users or Groups Window .....	141
Figure 40: Advanced Section of Select Users or Groups Window .....	142
Figure 41: Search Result Section.....	143
Figure 42: Object Names Section.....	143
Figure 43: Permissions Window.....	144
Figure 44: User Permissions.....	145
Figure 45: Advanced Sharing Window .....	146
Figure 46: WardGroup1-PC Path.....	146
Figure 47: Contingency Settings Page.....	147
Figure 48: Whiteboard Report Scheduler Association.....	148
Figure 49: EMS Fields Filled on the Facility Settings Page .....	148
Figure 50: EMS Fields Filled on the BMS Admin Page.....	149
Figure 51: EMS Staff Page for Mobile Devices .....	150
Figure 52: Adding a VistA Site .....	151
Figure 53: Schedulers Tab .....	152
Figure 54: VistA Integration Tab .....	153
Figure 55: Audit Tab .....	154
Figure 56: View Audit Results .....	155
Figure 57: NUMI Tab .....	157
Figure 58: Selecting the VistA Site for Which to Gather NUMI Data.....	157
Figure 59: Database Architecture .....	159
Figure 60: Backup Maintenance Plan .....	185

Figure 61: BMS External Interfaces.....	186
Figure 62 – Security services architecture .....	188
Figure 63 - <i>New Operation Definition</i> .....	217
Figure 64– Authentication use cases .....	217
Figure 65 – Authorization use cases .....	217
Figure 66 – Authorization administration use cases.....	218
Figure 67 – Class diagram for data contracts in PAP and PDP .....	240
Figure 68: 500 Internal Server Error .....	242
Figure 69: There are no Facilities.....	243
Figure 70: Unhandled Exception.....	244
Figure 71: Login Unsuccessful.....	245
Figure 72: EMS Bed Status Report is Missing.....	246
Figure 73: Report Cannot be Found.....	247
Figure 74: Admit Patient to Patients Pending Bed Placement Business Process .....	248
Figure 75: Transfer Patients Pending Bed Placement Business Process.....	248
Figure 76: Display and Update Patients Pending Bed Placement Business Process.....	248
Figure 77: Display and Update Bed Status Business Process.....	249
Figure 78: Manage Bed Cleaning Business Process .....	249
Figure 79: Create Notification Business Process.....	250
Figure 80: Create Facility Diversion Business Process .....	251
Figure 81: Manage Whiteboard Business Process.....	251
Figure 82: Reports Business Process.....	251
Figure 83: BMS Overview Activity Diagram .....	252
Figure 84: BMS Overview Functional Flow Diagram.....	253
Figure 85: BMS Overview Data Flow Diagram .....	254

# 1 Introduction

## 1.1 Purpose

This document is designed to provide sufficient technical information about the Bed Management Solution (BMS) application to the developers and Information Resources Management (IRM) technical personnel to operate and maintain the software.

## 1.2 BMS Overview

BMS is a real-time, user-friendly Web-based Veterans Health Information Systems and Technology Architecture (VistA) interface for tracking patient movement, bed status and bed availability. It provides performance information that can be used to improve patient flow within, and between, VA Medical Centers (VAMCs).

BMS allows administrative and clinical staff to record, manage and report on the planning, patient-movement, patient occupancy, and other activities related to management of beds. All patient admission, discharge, and transfer movements are sent directly from VistA to BMS.

BMS offers the following features:

- Tracks patient movement through the system;
- Displays patient and bed occupancy status for all beds in the facility and/or Veterans Integrated Service Networks (VISN);
- Provides visibility of bed availability within VAMC's to support emergency management;
- Automates request and assignment of beds;
- Displays and facilitates timely discharge appointments;
- Supports and facilitates efficient flow operations and is a catalyst to process improvement and best practices;
- Provides reports on performance measures associated with bed management and patient flow.

BMS provides answers to the following questions:

- How many beds do we have?
- How many empty beds do we have?
- How many available female beds do we have?
- How many beds are out of service and why?
- How long does it take to clean a bed?
- How many patients are waiting for beds in community hospitals?
- How many admissions, transfers, and discharges did my unit have yesterday?
- How many discharges will we have tomorrow?
- How many scheduled admissions do we have for today?

## 1.3 References

Requirements Specification Document (CLIN: 0002AA; title: Requirements Specification Document; file: Bed Management Solution (BMS) Technical Manual

## 2 Implementation and Maintenance

### 2.1 BMS Infrastructure Diagram

The BMS application has a list of physical components that can be divided on more physical servers according with their roles.

The following diagram represents a possible schema of physical deployment.

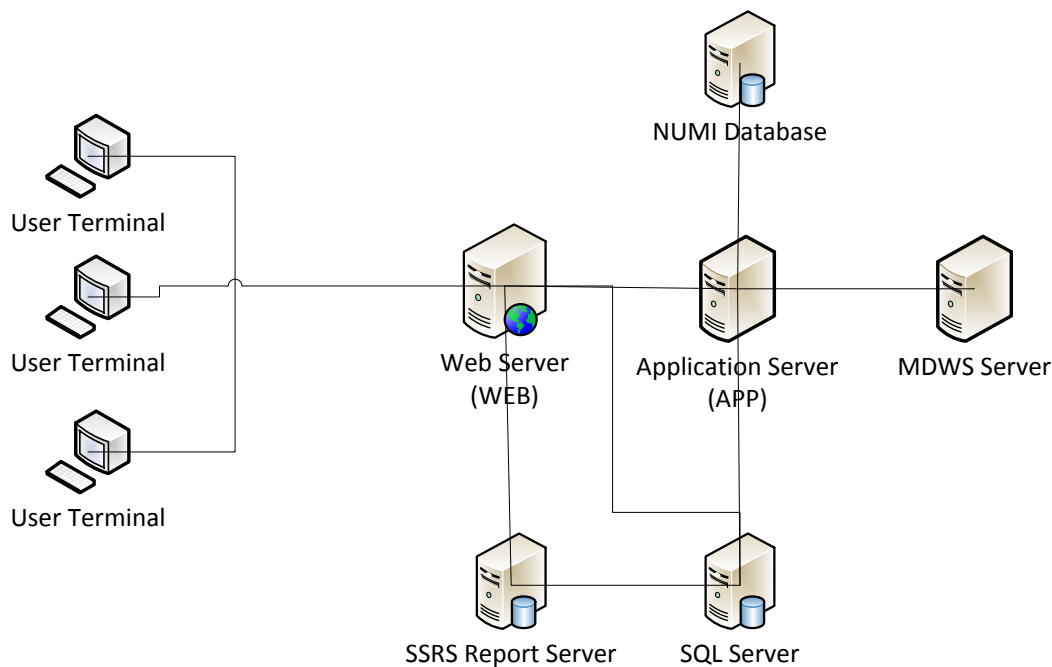

Figure 1: BMS Infrastructure Diagram

BMS is divided into specific components:

1. Persistence layer: SQL Server 2012 Enterprise database
2. Application server layer: Windows Communication Foundation (WCF) Web Services installed as Windows Services
3. Web server layer: Active Server Pages (ASP) .NET Model-View-Controller (MVC) Web application hosted in Internet Information Services (IIS)
4. Data Exchange Servers:
  - a. National Utilization Management Integration (NUMI) SQL Server Database

- b. VistA integration servers (servers that have access to VistA)
    - i. Medical Domain Web Services (MDWS): Web Service installed in IIS
5. Client Layer: Web Application client launched from browsers

## 2.2 System Requirements (Hardware and Software)

BMS requires the creation of a Master Windows Service Account User and numerous facility/Site Service Account Users for execution and operations.

All the BMS Application Services run under a service account.

- AITC has created the Windows User (acc\bms\_svc\_prod) as the master service account that the four BMS Services runs under. This can be referred to as the Master BMS Service Account.
- The <SERVERADDRESS>25 server hosts the four application services:
  - BMS.BedManagerService
  - BMS.SecurityHost
  - BMS.ServiceHost
- The <ServerAddress>26 server hosts the four application services:
  - BMS.VI.ServiceHost.
  - BMS.ServiceHost

All BMS Facilities/Sites require at least one service account for certain site functionality.

- This service account will run the EMS Mobile Page and Whiteboard Kiosk Page functions.
- Under BMS version 1.xx a single service account can be used for both functions.
- The service account that runs the EMS Mobile Page and Whiteboard Kiosk Page functions must not have any Policies assigned that restrict its use to specific computers.

BMS minimum hardware and software requirements are presented below:

Table 1: Server for Web Applications

Basic software:	Microsoft Windows Server 2008 64 bit R2 Standard Microsoft Clustering Services 2008 IIS 7.5 ASP.NET MVC5 .NET Framework 4.6.1
Application software:	Dashboards web application
Processor(s):	16 x Intel Xeon E5520 or equivalent
Memory:	32 GB
Hard disks:	190 GB
Network controller:	Broadcom NetXtreme Gigabit Ethernet, or equivalent

Table 2: Application Sever

Server 1	
<b>Basic software:</b>	Microsoft Windows Server 2008 64 bit R2 Standard .NET Framework 4.6.1
<b>Application software:</b>	EIS, EVS, DS, BMS InFlow
<b>Processor(s):</b>	14 x Intel Xeon E5520 or equivalent
<b>Memory:</b>	65 GB
<b>Hard disks:</b>	190 GB
<b>Network controller:</b>	Broadcom NetXtreme Gigabit Ethernet, or equivalent
Server 2	
<b>Basic software:</b>	Microsoft Windows Server 2008 64 bit R2 Standard .NET Framework 4.6.1
<b>Application software:</b>	EIS, EVS, DS, BMS InFlow
<b>Processor(s):</b>	12 x Intel Xeon E5520 or equivalent
<b>Memory:</b>	65 GB
<b>Hard disks:</b>	210 GB
<b>Network controller:</b>	Broadcom NetXtreme Gigabit Ethernet, or equivalent

Table 3: Database Server

<b>Basic software:</b>	Microsoft Windows Server 2008 64 bit R2 Standard Microsoft SQL Server 2012 Enterprise .NET Framework 4.6.1
<b>Application software:</b>	Databases used by the services installed on APP
<b>Processor(s):</b>	32 x Intel Xeon E5520 or equivalent
<b>Memory:</b>	136 GB
<b>Hard disks:</b>	1500 GB
<b>Network controller:</b>	Broadcom NetXtreme Gigabit Ethernet, or equivalent

## 2.3 Configuration Parameters

This section describes configuration parameters of the BMS application.

Table 4: BMS ServiceHost Configuration Parameters

Section	Configuration Key/Name	Configuration values (ex.)			Description
		Split Service		Combine Service	
		BMS.ServiceHost.config	BMS.VI.ServiceHost.exe.config	BMS.ServiceHost.config	
<b>configSections</b>	mtmodules	type="ePractice.MiddleTier.MTModuleSectionHandler, MiddleTier"			
	enterpriselibrary.configurationSettings	type="ePractice.Configuration.ConfigurationManagerSectionHandler, MS.Configuration"			
	pagingSortGroup	type="BMS.Utils.PagingSortSection, BMS.Utils" allowDefinition="Everywhere" allowExeDefinition="MachineToApplication" restartOnExternalChanges="true"			
	log4net	type="log4net.Config.Log4NetConfigurationSectionHandler, log4net"			
<b>connectionStrings</b>	Authorization	connectionString="Data Source=<DatabaseAddress>;Network Library=DBMSSOCN;Initial Catalog=BMS;Persist Security Info=False;Integrated Security=SSPI;Pooling=true;Min Pool Size=0;Max Pool Size=250;"	connectionString="Data Source=<DatabaseAddress>;Network Library=DBMSSOCN;Initial Catalog=BMS;Persist Security Info=False;Integrated Security=SSPI;Pooling=true;Min Pool Size=0;Max Pool Size=250;"	connectionString="Data Source=<DatabaseAddress>;Initial Catalog=BMS;Persist Security Info=False;Integrated Security=SSPI;Pooling=true;Min Pool Size=0;Max Pool Size=100;"	Connection string for the connection to the BMS database.
<b>appSettings</b>	DatasetPath	value="DBRepository"			
	LocalServer	value="yes"			
	UseSecurityContext	value="1"			Security - Authorization
	ePractice.MiddleTier.Transaction	value="MiddleTier.dll"			
	ConnectionRef	value="1"			
	TransactionProvider	value="ePractice.MiddleTier.CustomTransactionProvider"			
	VistaWorker.WorkerDelayTimeSpan	value="0:0:0:30"			Delay time from service start to first processing
	VistaWorker.WorkerPeriodTimeSpan	value="0:0:0:15"			Period between



Section	Configuration Key/Name	Configuration values (ex.)			Description
		Split Service		Combine Service	
		BMS.ServiceHost.config	BMS.VI.ServiceHost.exe.config	BMS.ServiceHost.config	
					worker processing steps
	VistaWorker.BulkSize	value="100"			Maximum number of processed entities in one step
	VistaWorker.Enabled	N/A (No longer used)			Whether vista worker is enabled or not (true or false)
	VistaIntegration.Enabled	value="false"	value="true"	value="true"	Whether vista integration is enabled or not (true or false)
	VistaIntegration.SchedulerSecondsLate	value="30"			The time delay of schedulers
	VistaIntegration.UpdateBmsPatients	value="true"			Whether update bms patients is enabled or not (true or false)
	Smtphost	value="smtp.va.gov"	value="smtp.va.gov"	value="localhost"	smtp host
	VistaWorker.VistaSitesFilePath	value="VistaSites.xml"			The vista sites configuration file name
	VistasBedHoldSupported	N/A			List of vista sites that support bed hold.
	visitorAppPwd	value="UM"			Password used by MDWS to connect to Vista.
	visitorUserSiteCode	value="523"			User Site Code used by MDWS to connect to

Section	Configuration Key/Name	Configuration values (ex.)		Description
		Split Service		Combine Service
		BMS.ServiceHost.config	BMS.VI.ServiceHost.exe.config	BMS.ServiceHost.config
				VistA.
	visitorUserName	< visitorUserName >		User Name used by MDWS to connect to VistA.
	visitorUserDuz	value="<visitorUserDuz >"		User Duz used by MDWS to connect to VistA.
	visitorUserSsn	value="<visitorUserSsn >"		User SSN used by MDWS to connect to VistA.
	visitorContext	value="<visitorContext >"		Context used by MDWS to connect to VistA.
	UsingNewMdwsMethods	value="true"		Whether use new mdws methods for vista integration (true or false)
	BMS_EIS_GET_ENTITY_FILTER_PAGE_SIZE	value="1000"		Number of records queried that are brought from EIS in one page.
	BMS_EVS_GET_CONCEPT_PAGE_SIZE	value="1000"		Number of records queried that are brought from EVS in one page.
	Changeset	value="72898"		Changeset of the installed

Section	Configuration Key/Name	Configuration values (ex.)			Description
		Split Service		Combine Service	
		BMS.ServiceHost.config	BMS.VI.ServiceHost.exe.config	BMS.ServiceHost.config	
					build.
	NumiSvcAuthenticationKey	value="<NumiSvcAuthenticationKey > "			NUMI service authentication key.
	NumiMaxNumberOfSitesPerCall	value="5"			Maximum number of sites that NUMI processes in one call.
	Is_IIS_Single_Instance	value="true"			Whether use SSL endpoint from configuration file. (true or false)
	UseCacheEndpointFromConfigWithSsl	value="true"			Whether use SSL endpoint from configuration file.
	ProxyPoolMaxCount	value="1000"	value="50"	value="1000"	The maximum number of proxies in the pool.
	MdwsEndpointUrl_1	N/A	<pre>&lt;add key="MdwsEndpointUrl_DFLT" value="http://&lt;ServerAddress&gt;:87/QuerySvc.asmx"/&gt; &lt;add key="MdwsEndpointUrl_R1" value="http://&lt;ServerAddress&gt;:88/QuerySvc.asmx"/&gt; &lt;add key="MdwsEndpointUrl_R2" value="http://&lt;ServerAddress&gt;:89/QuerySvc.asmx"/&gt; &lt;add key="MdwsEndpointUrl_R3" value="http://&lt;ServerAddress&gt;:90/QuerySvc.asmx"/&gt;</pre>	value="http://localhost:82/QuerySvc.asmx" value="http://localhost:82/QuerySvc.asmx"	MDWS instance URL address.

Section	Configuration Key/Name	Configuration values (ex.)			Description
		Split Service		Combine Service	
		BMS.ServiceHost.config	BMS.VI.ServiceHost.exe.config	BMS.ServiceHost.config	
		<pre> &gt; &lt;add key="MdwsEndpointUrl_R4" value="http://&lt;servername&gt;:91/QueryS vc.asmx"/&gt; &lt;add key="MdwsEndpointUrl_V1" value="http:// &lt;servername&gt;:92/QuerySvc.asmx"/&gt; &lt;add key="MdwsEndpointUrl_V2" value="http://&lt;servername&gt;:93/QueryS vc.asmx"/&gt; &lt;add key="MdwsEndpointUrl_V3" value="http://&lt;servername&gt;:94/QueryS vc.asmx"/&gt; &lt;add key="MdwsEndpointUrl_V4" value=":95/QuerySvc.asmx"/&gt; &lt;add key="MdwsEndpointUrl_V5" value="http://&lt;servername&gt;:96/QueryS vc.asmx"/&gt; &lt;add key="MdwsEndpointUrl_V6" value="http://&lt;servername&gt;:97/QueryS vc.asmx"/&gt; &lt;add key="MdwsEndpointUrl_V7" value="http://&lt;servername&gt;:98/QueryS vc.asmx"/&gt; &lt;add key="MdwsEndpointUrl_V8" value="http://&lt;servername&gt;:99/QueryS vc.asmx"/&gt; &lt;add key="MdwsEndpointUrl_V9" value="http://&lt;servername&gt;:100/Query Svc.asmx"/&gt; &lt;add key="MdwsEndpointUrl_V10" value="http://&lt;servername&gt;:101/Query Svc.asmx"/&gt; &lt;add key="MdwsEndpointUrl_V11" value="http://&lt;servername&gt;:102/Query Svc.asmx"/&gt; &lt;add key="MdwsEndpointUrl_V12" value="http://&lt;servername&gt;:103/Query Svc.asmx"/&gt; &lt;add key="MdwsEndpointUrl_V13" value="http://&lt;servername&gt;:104/Query </pre>			

Section	Configuration Key/Name	Configuration values (ex.)		Description
		Split Service		Combine Service
		BMS.ServiceHost.config	BMS.VI.ServiceHost.exe.config	BMS.ServiceHost.config
			<pre> Svc.asmx"/&gt; &lt;add key="MdwsEndpointUrl_V14" value="http://&lt;servername&gt;:105/Query Svc.asmx"/&gt; &lt;add key="MdwsEndpointUrl_V15" value="http://&lt;servername&gt;:106/Query Svc.asmx"/&gt; &lt;add key="MdwsEndpointUrl_V16" value="http://&lt;servername&gt;:107/Query Svc.asmx"/&gt; &lt;add key="MdwsEndpointUrl_V17" value="http://&lt;servername&gt;:108/Query Svc.asmx"/&gt; &lt;add key="MdwsEndpointUrl_V18" value="http://&lt;servername&gt;:109/Query Svc.asmx"/&gt; &lt;add key="MdwsEndpointUrl_V19" value="http://&lt;servername&gt;:110/Query Svc.asmx"/&gt; &lt;add key="MdwsEndpointUrl_V20" value="http://&lt;servername&gt;:111/Query Svc.asmx"/&gt; &lt;add key="MdwsEndpointUrl_V21" value="http://&lt;servername&gt;:112/Query Svc.asmx"/&gt; &lt;add key="MdwsEndpointUrl_V22" value="http://&lt;servername&gt;:113/Query Svc.asmx"/&gt; &lt;add key="MdwsEndpointUrl_V23" value="http://&lt;servername&gt;:114/Query Svc.asmx"/&gt; &lt;add key="MdwsEndpointUrl_GLA" value="http://&lt;servername&gt;:115/Query Svc.asmx"/&gt; &lt;add key="MdwsEndpointUrl_LAS" value="http://&lt;servername&gt;:116/Query Svc.asmx"/&gt; &lt;add key="MdwsEndpointUrl_LOM" value="http://&lt;servername&gt;:117/Query Svc.asmx"/&gt; &lt;add key="MdwsEndpointUrl_LON" </pre>	

Section	Configuration Key/Name	Configuration values (ex.)			Description
		Split Service		Combine Service	
		BMS.ServiceHost.config	BMS.VI.ServiceHost.exe.config	BMS.ServiceHost.config	
			<pre> value="http://&lt;servername&gt;:118/Query Svc.asmx"/&gt; &lt;add key="MdwsEndpointUrl_SDC" value="http://&lt;servername&gt;:119/Query Svc.asmx"/&gt; &lt;add key="MdwsEndpointUrl_KAN" value="http://&lt;servername&gt;:120/Query Svc.asmx"/&gt; &lt;add key="MdwsEndpointUrl_STL" value="http://&lt;servername&gt;:121/Query Svc.asmx"/&gt; &lt;add key="MdwsEndpointUrl_NFL" value="http://&lt;servername&gt;:122/Query Svc.asmx"/&gt; &lt;add key="MdwsEndpointUrl_WPB" value="http://&lt;servername&gt;:123/Query Svc.asmx"/&gt; &lt;add key="MdwsEndpointUrl_BAY" value="http://&lt;servername&gt;:124/Query Svc.asmx"/&gt; &lt;add key="MdwsEndpointUrl_MIA" value="http://&lt;servername&gt;:125/Query Svc.asmx"/&gt; &lt;add key="MdwsEndpointUrl_ORL" value="http://&lt;servername&gt;:126/Query Svc.asmx"/&gt; &lt;add key="MdwsEndpointUrl_SAJ" value="http://&lt;servername&gt;:127/Query Svc.asmx"/&gt; &lt;add key="MdwsEndpointUrl_TAM" value="http://&lt;servername&gt;:128/Query Svc.asmx"/&gt; &lt;add key="MdwsEndpointUrl_RSV1" value="http://&lt;servername&gt;:87/QueryS vc.asmx"/&gt; &lt;add key="MdwsEndpointUrl_RSV2" value="http://&lt;servername&gt;:88/QueryS vc.asmx"/&gt; &lt;add key="MdwsEndpointUrl_RSV3" value="http://&lt;servername&gt;:89/QueryS vc.asmx"/&gt; </pre>		

Section	Configuration Key/Name	Configuration values (ex.)			Description
		Split Service		Combine Service	
		BMS.ServiceHost.config	BMS.VI.ServiceHost.exe.config	BMS.ServiceHost.config	
			<pre> &lt;add key="MdwsEndpointUrl_RSV4" value="http://&lt;servername&gt;:90/QueryS vc.asmx"/&gt; &lt;add key="MdwsEndpointUrl_RSV5" value="http://&lt;servername&gt;:91/QueryS vc.asmx"/&gt; &lt;add key="MdwsEndpointUrl_RSV6" value="http://&lt;servername&gt;:92/QueryS vc.asmx"/&gt; &lt;add key="MdwsEndpointUrl_RSV7" value="http://&lt;servername&gt;:93/QueryS vc.asmx"/&gt; &lt;add key="MdwsEndpointUrl_RSV8" value="http://&lt;servername&gt;:94/QueryS vc.asmx"/&gt; &lt;add key="MdwsEndpointUrl_RSV9" value="http://&lt;servername&gt;:95/QueryS vc.asmx"/&gt; &lt;add key="MdwsEndpointUrl_RSV10" value="http://&lt;servername&gt;:96/QueryS vc.asmx"/&gt; &lt;add key="MdwsEndpointUrl_RSV11" value="http://&lt;servername&gt;:97/QueryS vc.asmx"/&gt; &lt;add key="MdwsEndpointUrl_RSV12" value="http://&lt;servername&gt;:98/QueryS vc.asmx"/&gt; &lt;add key="MdwsEndpointUrl_RSV13" value="http://&lt;servername&gt;:99/QueryS vc.asmx"/&gt; &lt;add key="MdwsEndpointUrl_RSV14" value="http://&lt;servername&gt;:100/Query Svc.asmx"/&gt; &lt;add key="MdwsEndpointUrl_RSV14" value="http://&lt;servername&gt;:101/Query Svc.asmx"/&gt; &lt;add key="MdwsEndpointUrl_RSV15" value="http://&lt;servername&gt;:102/Query Svc.asmx"/&gt; &lt;add key="MdwsEndpointUrl_RSV16" value="http://&lt;servername&gt;:103/Query </pre>		

Section	Configuration Key/Name	Configuration values (ex.)		Description
		Split Service		Combine Service
		BMS.ServiceHost.config	BMS.VI.ServiceHost.exe.config	BMS.ServiceHost.config
			<pre> Svc.asmx"/&gt; &lt;add key="MdwsEndpointUrl_RSV17" value="http://&lt;servername&gt;:104/Query Svc.asmx"/&gt; &lt;add key="MdwsEndpointUrl_RSV18" value="http://&lt;servername&gt;:105/Query Svc.asmx"/&gt; &lt;add key="MdwsEndpointUrl_RSV19" value="http://&lt;servername&gt;:106/Query Svc.asmx"/&gt; &lt;add key="MdwsEndpointUrl_RSV20" value="http://&lt;servername&gt;:107/Query Svc.asmx"/&gt; &lt;add key="MdwsEndpointUrl_RSV21" value="http://&lt;servername&gt;:108/Query Svc.asmx"/&gt; &lt;add key="MdwsEndpointUrl_RSV22" value="http://&lt;servername&gt;:109/Query Svc.asmx"/&gt; &lt;add key="MdwsEndpointUrl_RSV23" value="http://&lt;servername&gt;:110/Query Svc.asmx"/&gt; &lt;add key="MdwsEndpointUrl_RSV24" value="http://&lt;servername&gt;:111/Query Svc.asmx"/&gt; &lt;add key="MdwsEndpointUrl_RSV25" value="http://&lt;servername&gt;:112/Query Svc.asmx"/&gt; &lt;add key="MdwsEndpointUrl_RSV26" value="http://&lt;servername&gt;:113/Query Svc.asmx"/&gt; &lt;add key="MdwsEndpointUrl_RSV27" value="http://&lt;servername&gt;:114/Query Svc.asmx"/&gt; &lt;add key="MdwsEndpointUrl_GLA27" value="http://&lt;servername&gt;:115/Query Svc.asmx"/&gt; &lt;add key="MdwsEndpointUrl_LAS27" value="http://&lt;servername&gt;:116/Query Svc.asmx"/&gt; &lt;add key="MdwsEndpointUrl_LOM27" </pre>	



Section	Configuration Key/Name	Configuration values (ex.)			Description
		Split Service		Combine Service	
		BMS.ServiceHost.config	BMS.VI.ServiceHost.exe.config	BMS.ServiceHost.config	
			<pre> value="http://&lt;servername&gt;:117/Query Svc.asmx"/&gt; &lt;add key="MdwsEndpointUrl_LON27" value="http://&lt;servername&gt;:118/Query Svc.asmx"/&gt; &lt;add key="MdwsEndpointUrl_SDC27" value="http://&lt;servername&gt;:119/Query Svc.asmx"/&gt; &lt;add key="MdwsEndpointUrl_KAN27" value="http://&lt;servername&gt;:120/Query Svc.asmx"/&gt; &lt;add key="MdwsEndpointUrl_STL27" value="http://&lt;servername&gt;:121/Query Svc.asmx"/&gt; &lt;add key="MdwsEndpointUrl_NFL27" value="http://&lt;servername&gt;:122/Query Svc.asmx"/&gt; &lt;add key="MdwsEndpointUrl_WPB27" value="http://&lt;servername&gt;:123/Query Svc.asmx"/&gt; &lt;add key="MdwsEndpointUrl_BAY27" value="http://&lt;servername&gt;:124/Query Svc.asmx"/&gt; &lt;add key="MdwsEndpointUrl_MIA27" value="http://&lt;servername&gt;:125/Query Svc.asmx"/&gt; &lt;add key="MdwsEndpointUrl_ORL27" value="http://&lt;servername&gt;:126/Query Svc.asmx"/&gt; &lt;add key="MdwsEndpointUrl_SAJ27" value="http://&lt;servername&gt;:127/Query Svc.asmx"/&gt; &lt;add key="MdwsEndpointUrl_TAM27" value="http://&lt;servername&gt;:128/Query Svc.asmx"/&gt; </pre>		
	VistaIntegrationJobFailedMaxCount	value="25"			The maximum number of job failures until the system decides to

Section	Configuration Key/Name	Configuration values (ex.)			Description
		Split Service		Combine Service	
		BMS.ServiceHost.config	BMS.VI.ServiceHost.exe.config	BMS.ServiceHost.config	
					retry.
	VistaIntegrationJobFailedIncrementDateMinutes	value="10"			The time span (minutes) that the system decides to increment job's start date when the threshold of job failures is reached.
	VistaIntegrationJobFailedNotificationEmailTo				Recipient's email used when a job fails. (va_person@va.gov)
	VistaIntegrationJobFailedNotificationEmailFrom	value="BMSBackgroundProcessorAgent@va.gov"			Sender's email used when a job fails.
	BMS_EIS_LongRunningMethodsMaxConcurrentCalls	value="100"	value="75"	value="75"	
	BMS_EVS_LongRunningMethodsMaxConcurrentCalls	value="100"	value="100"	value="50"	
	BMSServiceHostStart Type	value="BMS"	value="BMS.VI"	value="ALL"	Identifies how BMS is ran and the the associate configuration file. (possible values: ALL, BMS, BMS.VI)
	VistaIntegration.Task SchedulerDelayMin	value="0"	value="0"	value="0"	
	VistaIntegration.Task SchedulerDelayMax	value="10"	value="10"	value="10"	
	VistaIntegration.Task	value="5"	value="5"	value="5"	

Section	Configuration Key/Name	Configuration values (ex.)		Description
		Split Service		Combine Service
		BMS.ServiceHost.config	BMS.VI.ServiceHost.exe.config	BMS.ServiceHost.config
	SchedulerDelayStep			
	ThreadPoolMaxWorkerThreads			value="200"
	VistaIntegration.PatientMovementlenDays		value="60"	value="60"
<b>pagingSortGroup\pagingSort</b>	sortColumnCode="entered"	sortColumnName="[A].[CREATION_DATE]"		
	sortColumnCode="patient"	sortColumnName="[PAT].[LAST_NAME], [PAT].[FIRST_NAME]"		
	sortColumnCode="facility"	sortColumnName="[F].[NAME]"		
	sortColumnCode="requestdt"	sortColumnName="[A].[CREATION_DATE]"		
	sortColumnCode="specialty"	sortColumnName="[REQSP].[DISPLAY_NAME]"		
	sortColumnCode="visn"	sortColumnName="[TR].[FACILITY_VISN]"		
	sortColumnCode="region"	sortColumnName="[TR].[FACILITY_REGION]"		
	sortColumnCode="eventdt"	sortColumnName="[AEVN].[CREATION_DATE]"		
	sortColumnCode="VacatedDate"	sortColumnCode="VacatedDate"		
	sortColumnCode="transferrequestdt"	sortColumnName="[A].[CREATION_DATE]"		
	sortColumnCode="transferrequestdt"	sortColumnName="[TR].[REQUESTED_DATE]"		
<b>mtmodules [defaultserver=""]</b>	assembly="General.MT.dll"	servername=""		
	assembly="BMS.MT.dll"	servername=""		
<b>enterpriselibrary.configurationSettings xmlns:xsd="http://</b>	configurationSections\configurationSection xsi:type="ReadOnlyC	storageProvider xsi:type="XmlFileStorageProviderData" name="XML File Storage Provider" path="securityConfiguration.config"		

Section	Configuration Key/Name	Configuration values (ex.)		Description	
		Split Service	Combine Service		
		BMS.ServiceHost.config	BMS.VI.ServiceHost.exe.config	BMS.ServiceHost.config	
<a href="http://www.w3.org/2001/XMLSchema">www.w3.org/2001/XMLSchema</a> <a href="http://www.w3.org/2001/XMLSchema-instance">xmlns:xsi="http://www.w3.org/2001/XMLSchema-instance"</a> <a href="http://www.microsoft.com/practices/enterpriselibrary/08-31-2004/configuration">applicationName="HMSI"</a> <a href="http://www.microsoft.com/practices/enterpriselibrary/08-31-2004/configuration">xmlns="http://www.microsoft.com/practices/enterpriselibrary/08-31-2004/configuration"</a>	configurationSectionData name="securityConfiguration" encrypt="false"	<dataTransformer xsi:type="XmlSerializerTransformerData" name="Xml Serializer Transformer"> <includeTypes> <includeType name="HMUserAccessAuthenticationProviderData" type="ePractice.Security.HMUserAccess.Configuration.HMUserAccessAuthenticationProviderData, Security.HMUserAccess"/> <includeType name="HMUserAccessAuthorizationProviderData" type="ePractice.Security.HMUserAccess.Configuration.HMUserAccessAuthorizationProviderData, Security.HMUserAccess"/> <includeType name="HMUserAccessRolesProviderData" type="ePractice.Security.HMUserAccess.Configuration.HMUserAccessRolesProviderData, Security.HMUserAccess"/> <includeType name="NullAuthenticationProviderData" type="ePractice.Security.Null.Configuration.NullAuthenticationProviderData, Security.Null"/> <includeType name="NullAuthorizationProviderData" type="ePractice.Security.Null.Configuration.NullAuthorizationProviderData, Security.Null"/> </includeTypes> </dataTransformer>			
	configurationSections\ configurationSection xsi:type="ReadOnlyConfigurationSectionData" name="cachingConfiguration" encrypt="false"	storageProvider xsi:type="XmlFileStorageProviderData" name="XML File Storage Provider" path="cachingConfiguration.config"	<dataTransformer xsi:type="XmlSerializerTransformerData" name="Xml Serializer Transformer"> <includeTypes/> </dataTransformer>		Caching configuration is for CLIENT
	configurationSections\ configurationSection xsi:type="ReadOnlyConfigurationSectionData" name="connectionConfiguration" encrypt="false"	storageProvider xsi:type="XmlFileStorageProviderData" name="XML File Storage Provider" path="connectionConfiguration.config"			Connection configuration is for SERVER

Section	Configuration Key/Name	Configuration values (ex.)			Description
		Split Service		Combine Service	
		BMS.ServiceHost.config	BMS.VI.ServiceHost.exe.config	BMS.ServiceHost.config	
		<pre>&lt;dataTransformer xsi:type="XmlSerializerTransformerData" name="Xml Serializer Transformer"&gt;   &lt;includeTypes&gt;     &lt;includeType name="ServicesDatabaseConnectionProviderData" type="ePractice.Connection.SingleDatabase.Configuration.ServicesDatabaseConnectionProviderData, Connections.SingleDatabase, Version=1.0.0.0, Culture=neutral, PublicKeyToken=null"/&gt;   &lt;/includeTypes&gt; &lt;/dataTransformer&gt;</pre>			
	keyAlgorithmStorageProvider	xsi:nil="true"			
<b>system.runtime.remoting</b>	application\channels\channel	type="System.Runtime.Remoting.Channels.Tcp.TcpChannel, System.Runtime.Remoting, Version=1.0.5000.0, Culture=neutral, PublicKeyToken=b77a5c561934e089" name="RegularChannel"			
<b>system.net</b>	connectionManagement\add	address="" maxconnection="1000"			
<b>system.serviceModel\services</b>	service	name="BMS.ServiceImplementation.BedManagerOperationsCore" behaviorConfiguration="ServiceBehavior"			
	host\base\baseAddresses\add	baseAddress="http://<ServerAddress>25:16050/BMSOperations"	baseAddress="http://<ServerAddress>26:16050/BMSOperations"	baseAddress="http://localhost:16050/BMSOperations"	
	endpoint	address="" bindingConfiguration="ServiceBinding" binding="wsFederationHttpBinding" contract="BMS.ServiceContracts.IBedManagerOperations"			
	endpoint	address="win" bindingConfiguration="WinBinding" binding="wsFederationHttpBinding" contract="BMS.ServiceContracts.IBedManagerOperations"			
	endpoint	contract="IMetadataExchange" binding="mexHttpBinding" address="mex"			
	endpoint	address="unsec" binding="basicHttpBinding" contract="BMS.ServiceContracts.IBedManagerOperations"			
	service	name="BMS.ServiceImplementation.BedManagerQueryCore" behaviorConfiguration="ServiceBehavior"			
	host\base\baseAddresses\add	baseAddress="http://<ServerAddress>25:16050/BMSQuery"	baseAddress="http://<ServerAddress>26:16050/BMSQuery"	baseAddress="http://localhost:16050/BMSQuery"	
	endpoint	address="" bindingConfiguration="ServiceBinding" binding="wsFederationHttpBinding" contract="BMS.ServiceContracts.IBedManagerQuery"			
	endpoint	address="win" bindingConfiguration="WinBinding" binding="wsFederationHttpBinding" contract="BMS.ServiceContracts.IBedManagerQuery"			
	endpoint	contract="IMetadataExchange" binding="mexHttpBinding" address="mex"			
	endpoint	address="unsec" binding="basicHttpBinding" contract="BMS.ServiceContracts.IBedManagerQuery"			
	service	name="BMS.ServiceImplementation.BedManagerCacheCore" behaviorConfiguration="ServiceBehavior"			

Section	Configuration Key/Name	Configuration values (ex.)		Description
		Split Service		Combine Service
		BMS.ServiceHost.config	BMS.VI.ServiceHost.exe.config	BMS.ServiceHost.config
	host\base\baseAddresses\add		baseAddress="http://<ServerAddress>26:16050/BMSCache"	baseAddress="http://localhost:16050/BMSCache"
	endpoint		address="" bindingConfiguration="ServiceBinding" binding="wsFederationHttpBinding" contract="BMS.ServiceContracts.IBedManagerCache"	address="" bindingConfiguration="ServiceBinding" binding="wsFederationHttpBinding" contract="BMS.ServiceContracts.IBedManagerCache"
	endpoint		address="win" bindingConfiguration="WinBinding" binding="wsFederationHttpBinding" contract="BMS.ServiceContracts.IBedManagerCache"	address="win" bindingConfiguration="WinBinding" binding="wsFederationHttpBinding" contract="BMS.ServiceContracts.IBedManagerCache"
	endpoint		contract="IMetadataExchange" binding="mexHttpBinding" address="mex"	contract="IMetadataExchange" binding="mexHttpBinding" address="mex"
	endpoint		address="unsec" binding="basicHttpBinding" contract="BMS.ServiceContracts.IBedManagerCache"	address="unsec" binding="basicHttpBinding" contract="BMS.ServiceContracts.IBedManagerCache"
	service	name="BMS.ServiceImplementation.ConfigurationOperationsCore" behaviorConfiguration="ServiceBehavior"		name="BMS.ServiceImplementation.ConfigurationOperationsCore" behaviorConfiguration="ServiceBehavior"
	host\base\baseAddresses\add	baseAddress="http://<ServerAddress>25:16050/BMSConfigurationOperations"		baseAddress="http://localhost:16050/BMSConfigurationOperations"

Section	Configuration Key/Name	Configuration values (ex.)			Description
		Split Service		Combine Service	
		BMS.ServiceHost.config	BMS.VI.ServiceHost.exe.config	BMS.ServiceHost.config	
	endpoint	address="" bindingConfiguration="ServiceBinding" binding="wsFederationHttpBinding" contract="BMS.ServiceContracts.IConfigurationOperations"		address="" bindingConfiguration="ServiceBinding" binding="wsFederationHttpBinding" contract="BMS.ServiceContracts.IConfigurationOperations"	
	endpoint	address="win" bindingConfiguration="WinBinding" binding="wsFederationHttpBinding" contract="BMS.ServiceContracts.IConfigurationOperations"		address="win" bindingConfiguration="WinBinding" binding="wsFederationHttpBinding" contract="BMS.ServiceContracts.IConfigurationOperations"	
	endpoint	contract="IMetadataExchange" binding="mexHttpBinding" address="mex"		contract="IMetadataExchange" binding="mexHttpBinding" address="mex"	
	endpoint	address="unsec" binding="basicHttpBinding" contract="BMS.ServiceContracts.IConfigurationOperations"		address="unsec" binding="basicHttpBinding" contract="BMS.ServiceContracts.IConfigurationOperations"	
	service	name="InfoWorld.Security.Authorization.AuthorizationSubscriber.AuthorizationSubscriber" behaviorConfiguration="ServiceBehavior"		name="InfoWorld.Security.Authorization.AuthorizationSubscriber.AuthorizationSubscriber" behaviorConfiguration="ServiceBehavior"	
	host\base\baseAddresses\add	baseAddress="http://<ServerAddress>25:16050/BMS/AuthorizationSubscriber"		baseAddress="http://localhost:16050/BMS/AuthorizationSubscriber"	

Section	Configuration Key/Name	Configuration values (ex.)		Description
		Split Service		Combine Service
		BMS.ServiceHost.config	BMS.VI.ServiceHost.exe.config	BMS.ServiceHost.config
	endpoint	address="" binding="wsFederationHttpBinding" bindingConfiguration="WinBinding" contract="InfoWorld.Security.Authorization.AuthorizationSubscriber.IAuthorizationSubscriber"		address="" binding="wsFederationHttpBinding" bindingConfiguration="WinBinding" contract="InfoWorld.Security.Authorization.AuthorizationSubscriber.IAuthorizationSubscriber"
	service		name="TransferFlow" behaviorConfiguration="WorkflowService"	name="TransferFlow" behaviorConfiguration="WorkflowService"
	host\base\baseAddresses\add		baseAddress="http://<ServerAddress>26:16050/TransferWF"	baseAddress="http://localhost:16050/TransferWF"
	endpoint		address="" bindingConfiguration="ServiceBinding" binding="wsFederationHttpBinding" contract="BMS.Workflows.WF.ITransferFlow"	address="" bindingConfiguration="ServiceBinding" binding="wsFederationHttpBinding" contract="BMS.Workflows.WF.ITransferFlow"
	endpoint		address="win" bindingConfiguration="WinBinding" binding="wsFederationHttpBinding" contract="BMS.Workflows.WF.ITransferFlow"	address="win" bindingConfiguration="WinBinding" binding="wsFederationHttpBinding" contract="BMS.Workflows.WF.ITransferFlow"
	endpoint		contract="IMetadataExchange" binding="mexHttpBinding" address="mex"	contract="IMetadataExchange" binding="mexHttpBinding" address="mex"



Section	Configuration Key/Name	Configuration values (ex.)		Description
		Split Service		Combine Service
		BMS.ServiceHost.config	BMS.VI.ServiceHost.exe.config	BMS.ServiceHost.config
	endpoint		address="unsec" binding="basicHttpBinding" contract="BMS.Workflows.WF.ITransferFlow"	address="unsec" binding="basicHttpBinding" contract="BMS.Workflows.WF.ITransferFlow"
	service		name="WaitingListFlow" behaviorConfiguration="WorkflowService"	name="WaitingListFlow" behaviorConfiguration="WorkflowService"
	host\base\baseAddresses\add		baseAddress="http://<ServerAddress>26:16050/WaitingListWF"	baseAddress="http://localhost:16050/WaitingListWF"
	endpoint		address="" bindingConfiguration="ServiceBinding" binding="wsFederationHttpBinding" contract="BMS.Workflows.WF.IWaitingListFlow"	address="" bindingConfiguration="ServiceBinding" binding="wsFederationHttpBinding" contract="BMS.Workflows.WF.IWaitingListFlow"
	endpoint		address="win" bindingConfiguration="WinBinding" binding="wsFederationHttpBinding" contract="BMS.Workflows.WF.IWaitingListFlow"	address="win" bindingConfiguration="WinBinding" binding="wsFederationHttpBinding" contract="BMS.Workflows.WF.IWaitingListFlow"
	endpoint		contract="IMetadataExchange" binding="mexHttpBinding" address="mex"	contract="IMetadataExchange" binding="mexHttpBinding" address="mex"
	endpoint		address="unsec" binding="basicHttpBinding" contract="BMS.Workflows.WF.IWaitingListFlow"	address="unsec" binding="basicHttpBinding" contract="BMS.Workflows.WF.IWaitingListFlow"

Section	Configuration Key/Name	Configuration values (ex.)		Description
		Split Service		Combine Service
		BMS.ServiceHost.config	BMS.VI.ServiceHost.exe.config	BMS.ServiceHost.config
	service		name="BedUnavailableFlow" behaviorConfiguration="WorkflowService"	name="BedUnavailableFlow" behaviorConfiguration="WorkflowService"
	host\base\baseAddresses\add		baseAddress="http://<ServerAddress>26:16050/BedUnavailableWF"	name="BedUnavailableFlow" behaviorConfiguration="WorkflowService"
	endpoint		address="" bindingConfiguration="ServiceBinding" binding="wsFederationHttpBinding" contract="BMS.Workflows.WF.IBedUnavailableFlow"	address="" bindingConfiguration="ServiceBinding" binding="wsFederationHttpBinding" contract="BMS.Workflows.WF.IBedUnavailableFlow"
	endpoint		address="win" bindingConfiguration="WinBinding" binding="wsFederationHttpBinding" contract="BMS.Workflows.WF.IBedUnavailableFlow"	address="win" bindingConfiguration="WinBinding" binding="wsFederationHttpBinding" contract="BMS.Workflows.WF.IBedUnavailableFlow"
	endpoint		contract="IMetadataExchange" binding="mexHttpBinding" address="mex"	contract="IMetadataExchange" binding="mexHttpBinding" address="mex"
	endpoint		address="unsec" binding="basicHttpBinding" contract="BMS.Workflows.WF.IBedUnavailableFlow"	address="unsec" binding="basicHttpBinding" contract="BMS.Workflows.WF.IBedUnavailableFlow"

Section	Configuration Key/Name	Configuration values (ex.)		Description
		Split Service		Combine Service
		BMS.ServiceHost.config	BMS.VI.ServiceHost.exe.config	BMS.ServiceHost.config
	service		name="BMS.ServiceImplementation.VistaQueryCore" behaviorConfiguration="ServiceBehavior"	name="BMS.ServiceImplementation.VistaQueryCore" behaviorConfiguration="ServiceBehavior"
	host\base\baseAddresses\add		baseAddress="http://<ServerAddress>26:16050/VistaQuery"	baseAddress="http://localhost:16050/VistaQuery"
	endpoint		address="" bindingConfiguration="ServiceBinding" binding="wsFederationHttpBinding" contract="BMS.ServiceContracts.IVistaWorkerQuery"	address="" bindingConfiguration="ServiceBinding" binding="wsFederationHttpBinding" contract="BMS.ServiceContracts.IVistaWorkerQuery"
	endpoint		address="win" bindingConfiguration="WinBinding" binding="wsFederationHttpBinding" contract="BMS.ServiceContracts.IVistaWorkerQuery"	address="win" bindingConfiguration="WinBinding" binding="wsFederationHttpBinding" contract="BMS.ServiceContracts.IVistaWorkerQuery"
	endpoint		contract="IMetadataExchange" binding="mexHttpBinding" address="mex"	contract="IMetadataExchange" binding="mexHttpBinding" address="mex"
	endpoint		address="unsec" binding="basicHttpBinding" contract="BMS.ServiceContracts.IVistaWorkerQuery"	address="unsec" binding="basicHttpBinding" contract="BMS.ServiceContracts.IVistaWorkerQuery"

Section	Configuration Key/Name	Configuration values (ex.)		Description
		Split Service		Combine Service
		BMS.ServiceHost.config	BMS.VI.ServiceHost.exe.config	BMS.ServiceHost.config
	service		name="BMS.VistaIntegration.HL7.ServiceImplementation.HL7OperationsCore" behaviorConfiguration="BasicBindingBehavior"	name="BMS.VistaIntegration.HL7.ServiceImplementation.HL7OperationsCore" behaviorConfiguration="BasicBindingBehavior"
	host\base\baseAddresses\add		baseAddress="http://<ServerAddress>26:16050/HL7Operations"	baseAddress="http://localhost:16050/HL7Operations"
	endpoint		address="" bindingConfiguration="messagingBinding" binding="basicHttpBinding" contract="BMS.VistaIntegration.HL7.ServiceContracts.IHL7Operations"	address="" bindingConfiguration="messagingBinding" binding="basicHttpBinding" contract="BMS.VistaIntegration.HL7.ServiceContracts.IHL7Operations"
	bindings\basicHttpBinding			
	binding		name="EVSBinding" maxReceivedMessageSize="2147483647" closeTimeout="00:10:00" openTimeout="00:10:00" receiveTimeout="00:15:00" sendTimeout="00:10:00"	name="EVSBinding" maxReceivedMessageSize="2147483647" closeTimeout="00:10:00" openTimeout="00:10:00" receiveTimeout="00:15:00" sendTimeout="00:10:00"
	binding		name="subscriptionBinding" maxBufferSize="2147483647" maxReceivedMessageSize="2147483647" closeTimeout="00:10:00" openTimeout="00:10:00" receiveTimeout="00:15:00" sendTimeout="00:10:00"	name="subscriptionBinding" maxBufferSize="2147483647" maxReceivedMessageSize="2147483647" closeTimeout="00:10:00" openTimeout="00:10:00" receiveTimeout="00:15:00" sendTimeout="00:10:00"

Section	Configuration Key/Name	Configuration values (ex.)		Description
		Split Service		Combine Service
		BMS.ServiceHost.config	BMS.VI.ServiceHost.exe.config	BMS.ServiceHost.config
	binding		name="messagingBinding" maxBufferSize="2147483647" maxReceivedMessageSize="2147483647" closeTimeout="00:10:00" openTimeout="00:10:00" receiveTimeout="00:15:00" sendTimeout="00:10:00"	name="messagingBinding" maxBufferSize="2147483647" maxReceivedMessageSize="2147483647" closeTimeout="00:10:00" openTimeout="00:10:00" receiveTimeout="00:15:00" sendTimeout="00:10:00"
	readerQuotas		maxDepth="2147483647" maxStringContentLength="2147483647" maxArrayLength="2147483647" maxBytesPerRead="2147483647" maxNameTableCharCount="2147483647"	maxDepth="2147483647" maxStringContentLength="2147483647" maxArrayLength="2147483647" maxBytesPerRead="2147483647" maxNameTableCharCount="2147483647"

Section	Configuration Key/Name	Configuration values (ex.)		Description
		Split Service		Combine Service
		BMS.ServiceHost.config	BMS.VI.ServiceHost.exe.config	BMS.ServiceHost.config
	binding		name="QuerySvcSoap" closeTimeout="00:10:00" openTimeout="00:10:00" receiveTimeout="00:15:00" sendTimeout="00:10:00" allowCookies="false" bypassProxyOnLocal="false" hostNameComparisonMode="StrongWildcard" maxBufferSize="2147483647" maxReceivedMessageSize="2147483647" messageEncoding="Text" textEncoding="utf-8" transferMode="Buffered" useDefaultWebProxy="true"	name="QuerySvcSoap" closeTimeout="00:10:00" openTimeout="00:10:00" receiveTimeout="00:15:00" sendTimeout="00:10:00" allowCookies="false" bypassProxyOnLocal="false" hostNameComparisonMode="StrongWildcard" maxBufferSize="2147483647" maxReceivedMessageSize="2147483647" messageEncoding="Text" textEncoding="utf-8" transferMode="Buffered" useDefaultWebProxy="true"
	readerQuotas		maxDepth="32" maxStringContentLength="2147483647" maxArrayLength="2147483647" maxBytesPerRead="2147483647" maxNameTableCharCount="2147483647"	maxDepth="32" maxStringContentLength="2147483647" maxArrayLength="2147483647" maxBytesPerRead="2147483647" maxNameTableCharCount="2147483647"
	security mode="None"			
	transport		clientCredentialType="None" proxyCredentialType="None" realm=""	clientCredentialType="None" proxyCredentialType="None" realm=""

Section	Configuration Key/Name	Configuration values (ex.)		Description
		Split Service		Combine Service
		BMS.ServiceHost.config	BMS.VI.ServiceHost.exe.config	BMS.ServiceHost.config
	message		clientCredentialType="UserName" algorithmSuite="Default"	clientCredentialType="Use rName" algorithmSuite="Default"
	binding		name="QuerySvcSoapHttps" closeTimeout="00:10:00" openTimeout="00:10:00" receiveTimeout="00:15:00" sendTimeout="00:10:00" allowCookies="false" bypassProxyOnLocal="false" hostNameComparisonMode="StrongW ildcard" maxBufferSize="2147483647" maxReceivedMessageSize="2147483 647" messageEncoding="Text" textEncoding="utf-8" transferMode="Buffered" useDefaultWebProxy="true"	name="QuerySvcSoapHttp s" closeTimeout="00:10:00" openTimeout="00:10:00" receiveTimeout="00:15:00" sendTimeout="00:10:00" allowCookies="false" bypassProxyOnLocal="fals e" hostNameComparisonMod e="StrongWildcard" maxBufferSize="21474836 47" maxReceivedMessageSiz e="2147483647" messageEncoding="Text" textEncoding="utf-8" transferMode="Buffered" useDefaultWebProxy="tru e"
	readerQuotas		maxDepth="32" maxStringContentLength="214748364 7" maxArrayLength="2147483647" maxBytesPerRead="2147483647" maxNameTableCharCount="21474836 47"	maxDepth="32" maxStringContentLength=" 2147483647" maxArrayLength="214748 3647" maxBytesPerRead="2147 483647" maxNameTableCharCount ="2147483647"
	security mode="Transport"			

Section	Configuration Key/Name	Configuration values (ex.)		Description
		Split Service		Combine Service
		BMS.ServiceHost.config	BMS.VI.ServiceHost.exe.config	BMS.ServiceHost.config
	transport		clientCredentialType="None" proxyCredentialType="None" realm=""	clientCredentialType="None" proxyCredentialType="None" realm=""
	wsFederationHttpBinding			
	binding		name="WSFederationHttpBinding_AuthenticatedService" maxReceivedMessageSize="2147483647" closeTimeout="00:10:00" openTimeout="00:10:00" receiveTimeout="00:15:00" sendTimeout="00:10:00"	name="WSFederationHttpBinding_AuthenticatedService" maxReceivedMessageSize="2147483647" closeTimeout="00:10:00" openTimeout="00:10:00" receiveTimeout="00:15:00" sendTimeout="00:10:00"
	readerQuotas		maxDepth="32" maxStringContentLength="2147483647" maxArrayLength="2147483647" maxBytesPerRead="4096" maxNameTableCharCount="16384"	maxDepth="32" maxStringContentLength="2147483647" maxArrayLength="2147483647" maxBytesPerRead="4096" maxNameTableCharCount="16384"
	security mode="Message" message		algorithmSuite="Default" issuedKeyType="SymmetricKey" issuedTokenType="http://docs.oasis-open.org/wss/oasis-wss-saml-token-profile-1.1#SAMLV2.0" negotiateServiceCredential="false" establishSecurityContext="true"	algorithmSuite="Default" issuedKeyType="SymmetricKey" issuedTokenType="http://docs.oasis-open.org/wss/oasis-wss-saml-token-profile-1.1#SAMLV2.0" negotiateServiceCredential="false" establishSecurityContext="true"



Section	Configuration Key/Name	Configuration values (ex.)			Description
		Split Service		Combine Service	
		BMS.ServiceHost.config	BMS.VI.ServiceHost.exe.config	BMS.ServiceHost.config	
	issuer	address="http://<ServerAddress>25:16050/STS/mex"	address="http://<ServerAddress>25:16050/STS/" binding="wsHttpBinding" bindingConfiguration="wsUserName"	address="http://localhost:16050/STS/" binding="wsHttpBinding" bindingConfiguration="wsUserName"	
	identity\dns		value="IWHM3STS"	value="IWHM3STS"	
	binding	name="ServiceBinding" maxBufferSize="2147483647" maxReceivedMessageSize="2147483647" closeTimeout="00:10:00" openTimeout="00:10:00" receiveTimeout="00:15:00" sendTimeout="00:10:00"	name="ServiceBinding" maxBufferSize="2147483647" maxReceivedMessageSize="2147483647" closeTimeout="00:10:00" openTimeout="00:10:00" receiveTimeout="00:15:00" sendTimeout="00:10:00"	name="ServiceBinding" maxBufferSize="2147483647" maxReceivedMessageSize="2147483647" closeTimeout="00:10:00" openTimeout="00:10:00" receiveTimeout="00:15:00" sendTimeout="00:10:00"	
	readerQuotas	maxDepth="32" maxStringContentLength="2147483647" maxArrayLength="2147483647" maxBytesPerRead="4096" maxNameTableCharCount="16384"	maxDepth="32" maxStringContentLength="2147483647" maxArrayLength="2147483647" maxBytesPerRead="4096" maxNameTableCharCount="16384"	maxDepth="32" maxStringContentLength="2147483647" maxArrayLength="2147483647" maxBytesPerRead="4096" maxNameTableCharCount="16384"	
	security mode="Message"				
	message issuedTokenType="http://docs.oasis-open.org/wss/oasis-wss-saml-token-profile-1.1#SAMLV2.0" negotiateServiceCredential="false" establishSecurityContext="true"	issuerMetadata address="http://<ServerAddress>25:16050/STS/mex"	issuerMetadata address="http://<ServerAddress>25:16050/STS/mex"	issuerMetadata address="http://localhost:16050/STS/mex"	

Section	Configuration Key/Name	Configuration values (ex.)			Description
		Split Service		Combine Service	
		BMS.ServiceHost.config	BMS.VI.ServiceHost.exe.config	BMS.ServiceHost.config	
	binding	name="WinBinding" maxBufferSize="2147483647" maxReceivedMessageSize="2147483647" closeTimeout="00:10:00" openTimeout="00:10:00" receiveTimeout="00:15:00" sendTimeout="00:10:00"	name="WinBinding" maxBufferSize="2147483647" maxReceivedMessageSize="2147483647" closeTimeout="00:10:00" openTimeout="00:10:00" receiveTimeout="00:15:00" sendTimeout="00:10:00"	name="WinBinding" maxBufferSize="2147483647" maxReceivedMessageSize="2147483647" closeTimeout="00:10:00" openTimeout="00:10:00" receiveTimeout="00:15:00" sendTimeout="00:10:00"	
	readerQuotas	maxDepth="32" maxStringContentLength="2147483647" maxArrayLength="2147483647" maxBytesPerRead="4096" maxNameTableCharCount="16384"	maxDepth="32" maxStringContentLength="2147483647" maxArrayLength="2147483647" maxBytesPerRead="4096" maxNameTableCharCount="16384"	maxDepth="32" maxStringContentLength="2147483647" maxArrayLength="2147483647" maxBytesPerRead="4096" maxNameTableCharCount="16384"	
	security mode="Message"				
	message	issuedTokenType="http://docs.oasis-open.org/wss/oasis-wss-saml-token-profile-1.1#SAMLV2.0" negotiateServiceCredential="false" establishSecurityContext="true"	issuedTokenType="http://docs.oasis-open.org/wss/oasis-wss-saml-token-profile-1.1#SAMLV2.0" negotiateServiceCredential="false" establishSecurityContext="true"	issuedTokenType="http://docs.oasis-open.org/wss/oasis-wss-saml-token-profile-1.1#SAMLV2.0" negotiateServiceCredential="false" establishSecurityContext="true"	
	issuer	address="http://<ServerAddress>25:16050/STS/Windows" binding="wsHttpBinding" bindingConfiguration="StsWinBinding"	address="http://<ServerAddress>25:16050/STS/Windows" binding="wsHttpBinding" bindingConfiguration="StsWinBinding"	address="http://localhost:16050/STS/Windows" binding="wsHttpBinding" bindingConfiguration="StsWinBinding"	
	identity\servicePrincipalName	value="host/localhost"	value="host/localhost"	value="host/localhost"	

Section	Configuration Key/Name	Configuration values (ex.)			Description
		Split Service		Combine Service	
		BMS.ServiceHost.config	BMS.VI.ServiceHost.exe.config	BMS.ServiceHost.config	
	binding	name="WinBindingHttps" maxBufferSize="2147483647" maxReceivedMessageSize="2147483647" closeTimeout="00:10:00" openTimeout="00:10:00" receiveTimeout="00:15:00" sendTimeout="00:10:00"	name="WinBindingHttps" maxBufferSize="2147483647" maxReceivedMessageSize="2147483647" closeTimeout="00:10:00" openTimeout="00:10:00" receiveTimeout="00:15:00" sendTimeout="00:10:00"	name="WinBindingHttps" maxBufferSize="2147483647" maxReceivedMessageSize="2147483647" closeTimeout="00:10:00" openTimeout="00:10:00" receiveTimeout="00:15:00" sendTimeout="00:10:00"	
	readerQuotas	maxDepth="32" maxStringContentLength="2147483647" maxArrayLength="2147483647" maxBytesPerRead="4096" maxNameTableCharCount="16384"	maxDepth="32" maxStringContentLength="2147483647" maxArrayLength="2147483647" maxBytesPerRead="4096" maxNameTableCharCount="16384"	maxDepth="32" maxStringContentLength="2147483647" maxArrayLength="2147483647" maxBytesPerRead="4096" maxNameTableCharCount="16384"	
	security mode="TransportWithMessageCredential"				
	message	issuedTokenType="http://docs.oasis-open.org/wss/oasis-wss-saml-token-profile-1.1#SAMLV2.0" negotiateServiceCredential="false" establishSecurityContext="true"	issuedTokenType="http://docs.oasis-open.org/wss/oasis-wss-saml-token-profile-1.1#SAMLV2.0" negotiateServiceCredential="false" establishSecurityContext="true"	issuedTokenType="http://docs.oasis-open.org/wss/oasis-wss-saml-token-profile-1.1#SAMLV2.0" negotiateServiceCredential="false" establishSecurityContext="true"	
	issuer	address="http://<ServerAddress>25:16050/STS/Windows" binding="wsHttpBinding" bindingConfiguration="StsWinBinding"	address="http://<ServerAddress>25:16050/STS/Windows" binding="wsHttpBinding" bindingConfiguration="StsWinBinding"	address="http://localhost:16050/STS/Windows" binding="wsHttpBinding" bindingConfiguration="StsWinBinding"	
	identity\servicePrincipalName	value="host/localhost"	value="host/localhost"	value="host/localhost"	
	wsHttpBinding				

Section	Configuration Key/Name	Configuration values (ex.)			Description
		Split Service		Combine Service	
		BMS.ServiceHost.config	BMS.VI.ServiceHost.exe.config	BMS.ServiceHost.config	
	binding	name="wsUserName" maxReceivedMessageSize="2147483647" closeTimeout="00:10:00" openTimeout="00:10:00" receiveTimeout="00:15:00" sendTimeout="00:10:00"			
	security mode="Message"				
	message	clientCredentialType="UserName" negotiateServiceCredential="false" algorithmSuite="Default" establishSecurityContext="true"			
	binding	name="StsWinBinding" closeTimeout="00:10:00" openTimeout="00:10:00" receiveTimeout="00:15:00" sendTimeout="00:10:00"			Kerberos/NTLM
	security mode="Message"				
	message	clientCredentialType="UserName" negotiateServiceCredential="false" algorithmSuite="Default" establishSecurityContext="true"	clientCredentialType="UserName" negotiateServiceCredential="false" algorithmSuite="Default" establishSecurityContext="true"	clientCredentialType="UserName" negotiateServiceCredential="false" algorithmSuite="Default" establishSecurityContext="true"	
	binding	name="StsWinBinding" closeTimeout="00:10:00" openTimeout="00:10:00" receiveTimeout="00:15:00" sendTimeout="00:10:00"	name="StsWinBinding" closeTimeout="00:10:00" openTimeout="00:10:00" receiveTimeout="00:15:00" sendTimeout="00:10:00"	name="StsWinBinding" closeTimeout="00:10:00" openTimeout="00:10:00" receiveTimeout="00:15:00" sendTimeout="00:10:00"	
	security mode="Message"	name="StsWinBinding" closeTimeout="00:10:00" openTimeout="00:10:00" receiveTimeout="00:15:00" sendTimeout="00:10:00"			
	message	clientCredentialType="Windows" negotiateServiceCredential="true" establishSecurityContext="true"			
	binding	name="wsBindConf" maxReceivedMessageSize="2147483647" closeTimeout="00:10:00" openTimeout="00:10:00" receiveTimeout="00:15:00" sendTimeout="00:10:00"			
	client				

Section	Configuration Key/Name	Configuration values (ex.)		Description	
		Split Service		Combine Service	
		BMS.ServiceHost.config	BMS.VI.ServiceHost.exe.config	BMS.ServiceHost.config	
	endpoint		address="http://<servername>:87/QuerySvc.asmx" binding="basicHttpBinding"  bindingConfiguration="QuerySvcSoap"  contract="QuerySvcService.QuerySvcSoap" name="QuerySvcSoap"	address="http://<servername>/mdws2/QuerySvc.asmx" binding="basicHttpBinding"  bindingConfiguration="QuerySvcSoap" contract="QuerySvcService.QuerySvcSoap" name="QuerySvcSoap"	MDWS2
	endpoint		address="https://>servername>.aac.dva.va.gov/Inpatient.asmx" binding="basicHttpBinding"  bindingConfiguration="QuerySvcSoapHttps" contract="BMS.ServicesWrapper.Proxy.InpatientSoap" name="InpatientSoap"	address="https://hceveah03:100/Inpatient.asmx" binding="basicHttpBinding"  bindingConfiguration="QuerySvcSoapHttps" contract="BMS.ServicesWrapper.Proxy.InpatientSoap" name="InpatientSoap"	NUMI

Section	Configuration Key/Name	Configuration values (ex.)		Description	
		Split Service		Combine Service	
		BMS.ServiceHost.config	BMS.VI.ServiceHost.exe.config	BMS.ServiceHost.config	
	endpoint		address="http://<ServerAddress>25:16050/PAP"  behaviorConfiguration="ClientCredentialsBehavior"  binding="wsFederationHttpBinding"  bindingConfiguration="WSFederationHttpBinding_AuthenticatedService"  contract="InfoWorld.Security.Authorization.PolicyAdministrationPoint.IAdministrativeFunctions"  name="PAP.AdministrativeFunctions"	address="http://localhost:16050/PAP"  behaviorConfiguration="ClientCredentialsBehavior"  binding="wsFederationHttpBinding"  bindingConfiguration="WSFederationHttpBinding_AuthenticatedService"  contract="InfoWorld.Security.Authorization.PolicyAdministrationPoint.IAdministrativeFunctions"  name="PAP.AdministrativeFunctions"	PAP
	identity\dns		value="IWHM3Services"	value="IWHM3Services"	

Section	Configuration Key/Name	Configuration values (ex.)		Description	
		Split Service		Combine Service	
		BMS.ServiceHost.config	BMS.VI.ServiceHost.exe.config	BMS.ServiceHost.config	
	endpoint		endpoint address="http://<ServerAddress>25:16050/PDP"  behaviorConfiguration="ClientCredentialsBehavior" binding="wsFederationHttpBinding"  bindingConfiguration="WSFederationHttpBinding_AuthenticatedService"  contract="InfoWorld.Security.PolicyDecisionPoint.IAuthorizationService" name="PDP.AuthorizationService"	address="http://localhost:16050/PDP"  behaviorConfiguration="ClientCredentialsBehavior"  binding="wsFederationHttpBinding"  bindingConfiguration="WSFederationHttpBinding_AuthenticatedService"  contract="InfoWorld.Security.PolicyDecisionPoint.IAuthorizationService"  name="PDP.AuthorizationService"	PDP
	identity\dns		value="IWHM3Services"	value="IWHM3Services"	

Section	Configuration Key/Name	Configuration values (ex.)		Description	
		Split Service		Combine Service	
		BMS.ServiceHost.config	BMS.VI.ServiceHost.exe.config	BMS.ServiceHost.config	
	endpoint		address="http://<ServerAddress>25:16050/PAP"  behaviorConfiguration="WindowsClientCredentials"  binding="wsFederationHttpBinding"  bindingConfiguration="WinBinding"  contract="InfoWorld.Security.Authorization.PolicyAdministrationPoint.IAdministrativeFunctions"  name="PAP.AdministrativeFunctions.Windows"	address="http://localhost:16050/PAP"  behaviorConfiguration="WindowsClientCredentials"  binding="wsFederationHttpBinding"  bindingConfiguration="WinBinding"  contract="InfoWorld.Security.Authorization.PolicyAdministrationPoint.IAdministrativeFunctions"  name="PAP.AdministrativeFunctions.Windows"	PAP: Windows authentication
	identity\dns		value="IWHM3Services"	value="IWHM3Services"	



Section	Configuration Key/Name	Configuration values (ex.)		Description	
		Split Service		Combine Service	
		BMS.ServiceHost.config	BMS.VI.ServiceHost.exe.config	BMS.ServiceHost.config	
	endpoint		address="http://<ServerAddress>25:16050/PDP"  behaviorConfiguration="WindowsClientCredentials" binding="wsFederationHttpBinding" bindingConfiguration="WinBinding"  contract="InfoWorld.Security.PolicyDecisionPoint.IAuthorizationService"  name="PDP.AuthorizationService.Windows"	address="http://localhost:16050/PDP"  behaviorConfiguration="WindowsClientCredentials"  binding="wsFederationHttpBinding"  bindingConfiguration="WinBinding"  contract="InfoWorld.Security.PolicyDecisionPoint.IAuthorizationService"  name="PDP.AuthorizationService.Windows"	PDP: Windows authentication
	identity\dns		value="IWHM3Services"	value="IWHM3Services"	

Section	Configuration Key/Name	Configuration values (ex.)		Description	
		Split Service		Combine Service	
		BMS.ServiceHost.config	BMS.VI.ServiceHost.exe.config	BMS.ServiceHost.config	
	endpoint		address="http://<ServerAddress>26:16050/QueryFunctions"  behaviorConfiguration="ClientCredentialsBehavior" binding="wsFederationHttpBinding"  bindingConfiguration="WSFederationHttpBinding_AuthenticatedService" name="EIS.QueryFunctions"  contract="InfoWorld.EIS.IQueryFunctions"	address="http://localhost:16050/QueryFunctions"  behaviorConfiguration="ClientCredentialsBehavior"  binding="wsFederationHttpBinding"  bindingConfiguration="WSFederationHttpBinding_AuthenticatedService"  name="EIS.QueryFunctions"  contract="InfoWorld.EIS.IQueryFunctions"	EIS: QueryFunctions
	identity\dns		value="IWHM3Services"	value="IWHM3Services"	

Section	Configuration Key/Name	Configuration values (ex.)		Description	
		Split Service		Combine Service	
		BMS.ServiceHost.config	BMS.VI.ServiceHost.exe.config	BMS.ServiceHost.config	
	endpoint		address="http://<ServerAddress>26:16050/QueryFunctions"  behaviorConfiguration="WindowsClientCredentials" binding="wsFederationHttpBinding" bindingConfiguration="WinBinding"  contract="InfoWorld.EIS.IQueryFunctions"  name="EIS.QueryFunctions.Windows"	address="http://localhost:16050/QueryFunctions"  behaviorConfiguration="WindowsClientCredentials"  binding="wsFederationHttpBinding"  bindingConfiguration="WinBinding"  contract="InfoWorld.EIS.IQueryFunctions"  name="EIS.QueryFunctions.Windows"	EIS: Windows authentication
	identity\dns		value="IWHM3Services"	value="IWHM3Services"	

Section	Configuration Key/Name	Configuration values (ex.)			Description
		Split Service		Combine Service	
		BMS.ServiceHost.config	BMS.VI.ServiceHost.exe.config	BMS.ServiceHost.config	
	endpoint		address="http://<ServerAddress>26:16050/EntityManagement"  behaviorConfiguration="ClientCredentialsBehavior" binding="wsFederationHttpBinding" name="EIS.EntityManagement"  bindingConfiguration="WSFederationHttpBinding_AuthenticatedService"  contract="InfoWorld.EIS.IEntityManagement"	address="http://localhost:16050/EntityManagement"  behaviorConfiguration="ClientCredentialsBehavior"  binding="wsFederationHttpBinding"  name="EIS.EntityManagement"  bindingConfiguration="WSFederationHttpBinding_AuthenticatedService"  contract="InfoWorld.EIS.IEntityManagement"	EIS: EntityManagement
	identity\dns		value="IWHM3Services"	value="IWHM3Services"	

Section	Configuration Key/Name	Configuration values (ex.)		Description	
		Split Service		Combine Service	
		BMS.ServiceHost.config	BMS.VI.ServiceHost.exe.config	BMS.ServiceHost.config	
	endpoint		address="http://<ServerAddress>26:16050/EntityManagement"  behaviorConfiguration="WindowsClientCredentials" binding="wsFederationHttpBinding"  name="EIS.EntityManagement.Windows" bindingConfiguration="WinBinding"  contract="InfoWorld.EIS.IEntityManagement"	address="http://localhost:16050/EntityManagement"  behaviorConfiguration="WindowsClientCredentials"  binding="wsFederationHttpBinding"  name="EIS.EntityManagement.Windows"  bindingConfiguration="WinBinding"  contract="InfoWorld.EIS.IEntityManagement"	EIS: Windows authentication
	identity\dns		value="IWHM3Services"	value="IWHM3Services"	
	endpoint		address="http://<ServerAddress>26:16050/CTSVocabularyRuntime" name="EVS.CTSVocabularyRuntime" binding="basicHttpBinding" bindingConfiguration="EVSBinding" contract="InfoWorld.EVS.CTSVAPI.RuntimeOperations" behaviorConfiguration="DataContractSerializer"	address="http://localhost:16050/CTSVocabularyRuntime" name="EVS.CTSVocabularyRuntime" binding="basicHttpBinding"  bindingConfiguration="EVSBinding" contract="InfoWorld.EVS.CTSVAPI.RuntimeOperations" behaviorConfiguration="DataContractSerializer"	EVS

Section	Configuration Key/Name	Configuration values (ex.)		Description
		Split Service		Combine Service
		BMS.ServiceHost.config	BMS.VI.ServiceHost.exe.config	BMS.ServiceHost.config
	endpoint		address="http://<ServerAddress>26:16050/CTSVocabularyBrowse" name="EVS.CTSVocabularyBrowse" binding="basicHttpBinding" bindingConfiguration="EVSBinding" contract="InfoWorld.EVS.CTSVAPI.BrowserOperations" behaviorConfiguration="DataContractSerializer"	address="http://localhost:16050/CTSVocabularyBrowse" name="EVS.CTSVocabularyBrowse" binding="basicHttpBinding" bindingConfiguration="EVSBinding" contract="InfoWorld.EVS.CTSVAPI.BrowserOperations" behaviorConfiguration="DataContractSerializer"
	endpoint		address="http://<ServerAddress>26:16050/CTSMMessageBrowse" name="EVS.CTSMMessageBrowse" binding="basicHttpBinding" bindingConfiguration="EVSBinding" contract="InfoWorld.EVS.CTSMAPI.BrowserOperations" behaviorConfiguration="DataContractSerializer"	address="http://localhost:16050/CTSMMessageBrowse" name="EVS.CTSMMessageBrowse" binding="basicHttpBinding" bindingConfiguration="EVSBinding" contract="InfoWorld.EVS.CTSMAPI.BrowserOperations" behaviorConfiguration="DataContractSerializer"
	endpoint		address="http://<ServerAddress>26:16050/CTSMMessageRuntime" name="EVS.CTSMMessageRuntime" binding="basicHttpBinding" bindingConfiguration="EVSBinding" contract="InfoWorld.EVS.CTSMAPI.RuntimeOperations" behaviorConfiguration="DataContractSerializer"	address="http://localhost:16050/CTSMMessageRuntime" name="EVS.CTSMMessageRuntime" binding="basicHttpBinding" bindingConfiguration="EVSBinding" contract="InfoWorld.EVS.CTSMAPI.RuntimeOperations" behaviorConfiguration="Da

Section	Configuration Key/Name	Configuration values (ex.)			Description
		Split Service		Combine Service	
		BMS.ServiceHost.config	BMS.VI.ServiceHost.exe.config	BMS.ServiceHost.config	
				taContractSerializer"	
	endpoint		address="http://<ServerAddress>26:16050/CTSMMessageEdit" name="EVS.CTSMMessageEdit" binding="basicHttpBinding" bindingConfiguration="EVSBinding" contract="InfoWorld.EVS.CTSEdit.IMessageEdit" behaviorConfiguration="DataContractSerializer"	address="http://localhost:16050/CTSMMessageEdit" name="EVS.CTSMMessageEdit" binding="basicHttpBinding" bindingConfiguration="EVSBinding" contract="InfoWorld.EVS.CTSEdit.IMessageEdit" behaviorConfiguration="DataContractSerializer"	
	endpoint		address="http://<ServerAddress>26:16050/CTSVocabularyEdit" name="EVS.CTSVocabularyEdit" binding="basicHttpBinding" bindingConfiguration="EVSBinding" contract="ICTSEditVocabulary"	address="http://localhost:16050/CTSVocabularyEdit" name="EVS.CTSVocabularyEdit" binding="basicHttpBinding" bindingConfiguration="EVSBinding" contract="ICTSEditVocabulary"	

Section	Configuration Key/Name	Configuration values (ex.)			Description
		Split Service		Combine Service	
		BMS.ServiceHost.config	BMS.VI.ServiceHost.exe.config	BMS.ServiceHost.config	
	endpoint		address="http://<ServerAddress>26:16050/BMSQuery"  behaviorConfiguration="ClientCredentialsBehavior" binding="wsFederationHttpBinding"  bindingConfiguration="WSFederationHttpBinding_AuthenticatedService" name="BMS.BMSQuery"  contract="BMS.ServiceContracts.IBedManagerQuery"	address="http://localhost:16050/BMSQuery"  behaviorConfiguration="ClientCredentialsBehavior"  binding="wsFederationHttpBinding"  bindingConfiguration="WSFederationHttpBinding_AuthenticatedService"  name="BMS.BMSQuery"  contract="BMS.ServiceContracts.IBedManagerQuery"	BMS Query
	identity\dns		value="IWHM3Services"	value="IWHM3Services"	



Section	Configuration Key/Name	Configuration values (ex.)			Description
		Split Service		Combine Service	
		BMS.ServiceHost.config	BMS.VI.ServiceHost.exe.config	BMS.ServiceHost.config	
	endpoint		address="http://<ServerAddress>26:16050/BMSQuery"  behaviorConfiguration="WindowsClientCredentials" binding="wsFederationHttpBinding" bindingConfiguration="WinBinding" name="BMS.BMSQuery.Windows"  contract="BMS.ServiceContracts.IBedManagerQuery"	address="http://localhost:16050/BMSQuery"  behaviorConfiguration="WindowsClientCredentials"  binding="wsFederationHttpBinding"  bindingConfiguration="WinBinding"  name="BMS.BMSQuery.Windows"  contract="BMS.ServiceContracts.IBedManagerQuery"	BMS Query: Windows
	identity\dns		value="IWHM3Services"	value="IWHM3Services"	

Section	Configuration Key/Name	Configuration values (ex.)		Description	
		Split Service		Combine Service	
		BMS.ServiceHost.config	BMS.VI.ServiceHost.exe.config	BMS.ServiceHost.config	
	endpoint		address="http://<ServerAddress>26:16050/BMSOperations"  behaviorConfiguration="ClientCredentialsBehavior" binding="wsFederationHttpBinding"  bindingConfiguration="WSFederationHttpBinding_AuthenticatedService" name="BMS.BMSOperations"  contract="BMS.ServiceContracts.IBedManagerOperations"	address="http://localhost:16050/BMSOperations"  behaviorConfiguration="ClientCredentialsBehavior"  binding="wsFederationHttpBinding"  bindingConfiguration="WSFederationHttpBinding_AuthenticatedService"  name="BMS.BMSOperations"  contract="BMS.ServiceContracts.IBedManagerOperations"	BMS Operations
	identity\dns		value="IWHM3Services"	value="IWHM3Services"	

Section	Configuration Key/Name	Configuration values (ex.)		Description	
		Split Service		Combine Service	
		BMS.ServiceHost.config	BMS.VI.ServiceHost.exe.config	BMS.ServiceHost.config	
	endpoint		address="http://<ServerAddress>26:16050/BMSOperations"  behaviorConfiguration="WindowsClientCredentials" binding="wsFederationHttpBinding" bindingConfiguration="WinBinding"  name="BMS.BMSOperations.Windows"  contract="BMS.ServiceContracts.IBedManagerOperations"	address="http://localhost:16050/BMSOperations"  behaviorConfiguration="WindowsClientCredentials"  binding="wsFederationHttpBinding"  bindingConfiguration="WinBinding"  name="BMS.BMSOperations.Windows"  contract="BMS.ServiceContracts.IBedManagerOperations"	BMS Operations: Windows
	identity\dns		value="IWHM3Services"	value="IWHM3Services"	

Section	Configuration Key/Name	Configuration values (ex.)		Description	
		Split Service		Combine Service	
		BMS.ServiceHost.config	BMS.VI.ServiceHost.exe.config	BMS.ServiceHost.config	
	endpoint		address="http://<ServerAddress>25:16050/BMSConfigurationOperations"  behaviorConfiguration="ClientCredentialsBehavior" binding="wsFederationHttpBinding"  bindingConfiguration="WSFederationHttpBinding_AuthenticatedService" name ="BMS.BMSConfigurationOperations"  contract="BMS.ServiceContracts.IConfigurationOperations"	address="http://localhost:16050/BMSConfigurationOperations"  behaviorConfiguration="ClientCredentialsBehavior"  binding="wsFederationHttpBinding"  bindingConfiguration="WSFederationHttpBinding_AuthenticatedService" name ="BMS.BMSConfigurationOperations"  contract="BMS.ServiceContracts.IConfigurationOperations"	BMS Configuration
	identity\dns		value="IWHM3Services"	value="IWHM3Services"	

Section	Configuration Key/Name	Configuration values (ex.)			Description
		Split Service		Combine Service	
		BMS.ServiceHost.config	BMS.VI.ServiceHost.exe.config	BMS.ServiceHost.config	
	endpoint		address="http://<ServerAddress>25:16050/BMSConfigurationOperations"  behaviorConfiguration="WindowsClientCredentials" binding="wsFederationHttpBinding" bindingConfiguration="WinBinding" name ="BMS.BMSConfigurationOperations.Windows"  contract="BMS.ServiceContracts.IConfigurationOperations"	address="http://localhost:16050/BMSConfigurationOperations"  behaviorConfiguration="WindowsClientCredentials"  binding="wsFederationHttpBinding"  bindingConfiguration="WinBinding" name ="BMS.BMSConfigurationOperations.Windows"  contract="BMS.ServiceContracts.IConfigurationOperations"	BMS Configuration: Windows
	identity\dns		value="IWHM3Services"	value="IWHM3Services"	

Section	Configuration Key/Name	Configuration values (ex.)		Description	
		Split Service		Combine Service	
		BMS.ServiceHost.config	BMS.VI.ServiceHost.exe.config	BMS.ServiceHost.config	
	endpoint		address="http://<ServerAddress>26:16050/BedUnavailableWF"  behaviorConfiguration="ClientCredentialsBehavior" binding="wsFederationHttpBinding"  bindingConfiguration="WSFederationHttpBinding_AuthenticatedService"  name="BMSWF.IBedUnavailableFlow"  contract="BMS.Workflows.WF.IBedUnavailableFlow"	address="http://localhost:16050/BedUnavailableWF"  behaviorConfiguration="ClientCredentialsBehavior"  binding="wsFederationHttpBinding"  bindingConfiguration="WSFederationHttpBinding_AuthenticatedService"  name="BMSWF.IBedUnavailableFlow"  contract="BMS.Workflows.WF.IBedUnavailableFlow"	Bed Unavailable Workflow
	identity\dns		value="IWHM3Services"	value="IWHM3Services"	

Section	Configuration Key/Name	Configuration values (ex.)			Description
		Split Service		Combine Service	
		BMS.ServiceHost.config	BMS.VI.ServiceHost.exe.config	BMS.ServiceHost.config	
	endpoint		address="http://<ServerAddress>26:16050/BedUnavailableWF"  behaviorConfiguration="WindowsClientCredentials" binding="wsFederationHttpBinding" bindingConfiguration="WinBinding"  name="BMSWF.IBedUnavailableFlow.Windows"  contract="BMS.Workflows.WF.IBedUnavailableFlow"	address="http://localhost:16050/BedUnavailableWF"  behaviorConfiguration="WindowsClientCredentials"  binding="wsFederationHttpBinding"  bindingConfiguration="WinBinding"  name="BMSWF.IBedUnavailableFlow.Windows"  contract="BMS.Workflows.WF.IBedUnavailableFlow"	Bed Unavailable Workflow: Windows
	identity\dns		value="IWHM3Services"	value="IWHM3Services"	

Section	Configuration Key/Name	Configuration values (ex.)			Description
		Split Service		Combine Service	
		BMS.ServiceHost.config	BMS.VI.ServiceHost.exe.config	BMS.ServiceHost.config	
	endpoint		address="http://<ServerAddress>26:16050/WaitingListWF"  behaviorConfiguration="ClientCredentialsBehavior" binding="wsFederationHttpBinding"  bindingConfiguration="WSFederationHttpBinding_AuthenticatedService" name="BMSWF.IWaitingListFlow"  contract="BMS.Workflows.WF.IWaitingListFlow"	address="http://localhost:16050/WaitingListWF"  behaviorConfiguration="ClientCredentialsBehavior"  binding="wsFederationHttpBinding"  bindingConfiguration="WSFederationHttpBinding_AuthenticatedService"  name="BMSWF.IWaitingListFlow"  contract="BMS.Workflows.WF.IWaitingListFlow"	Waiting List Workflow
	identity\dns		value="IWHM3Services"	value="IWHM3Services"	



Section	Configuration Key/Name	Configuration values (ex.)		Description	
		Split Service		Combine Service	
		BMS.ServiceHost.config	BMS.VI.ServiceHost.exe.config	BMS.ServiceHost.config	
	endpoint		address="http://<ServerAddress>26:16050/WaitingListWF"  behaviorConfiguration="WindowsClientCredentials" binding="wsFederationHttpBinding" bindingConfiguration="WinBinding"  name="BMSWF.IWaitingListFlow.Windows"  contract="BMS.Workflows.WF.IWaitingListFlow"	address="http://localhost:16050/WaitingListWF"  behaviorConfiguration="ClientCredentialsBehavior"  binding="wsFederationHttpBinding"  bindingConfiguration="WSFederationHttpBinding_AuthenticatedService"  name="BMSWF.IWaitingListFlow"  contract="BMS.Workflows.WF.IWaitingListFlow"	Waiting List Workflow
	identity\dns		value="IWHM3Services"	value="IWHM3Services"	

Section	Configuration Key/Name	Configuration values (ex.)		Description	
		Split Service		Combine Service	
		BMS.ServiceHost.config	BMS.VI.ServiceHost.exe.config	BMS.ServiceHost.config	
	endpoint		address="http://<ServerAddress>26:16050/VistaQuery"  behaviorConfiguration="ClientCredentialsBehavior" binding="wsFederationHttpBinding"  bindingConfiguration="WSFederationHttpBinding_AuthenticatedService"  contract="BMS.ServiceContracts.IVistaWorkerQuery" name ="BMS.VistaQuery"	address="http://localhost:16050/WaitingListWF"  behaviorConfiguration="WindowsClientCredentials"  binding="wsFederationHttpBinding"  bindingConfiguration="WindowsBinding"  name="BMSWF.IWaitingListFlow.Windows"  contract="BMS.Workflows.WF.IWaitingListFlow"	Waiting List Workflow: Windows
	identity\dns		value="IWHM3Services"	value="IWHM3Services"	

Section	Configuration Key/Name	Configuration values (ex.)			Description
		Split Service		Combine Service	
		BMS.ServiceHost.config	BMS.VI.ServiceHost.exe.config	BMS.ServiceHost.config	
	endpoint		address="http://<ServerAddress>26:16050/VistaQuery"  behaviorConfiguration="WindowsClientCredentials" binding="wsFederationHttpBinding" bindingConfiguration="WinBinding"  contract="BMS.ServiceContracts.IVistaWorkerQuery" name ="BMS.VistaQuery.Windows"	address="http://localhost:16050/VistaQuery"  behaviorConfiguration="WindowsClientCredentials"  binding="wsFederationHttpBinding"  bindingConfiguration="WinBinding"  contract="BMS.ServiceContracts.IVistaWorkerQuery" name ="BMS.VistaQuery.Windows"	BMS Vista Query - Configuration Windows
	identity\dns		value="IWHM3Services"	value="IWHM3Services"	

Section	Configuration Key/Name	Configuration values (ex.)		Description	
		Split Service		Combine Service	
		BMS.ServiceHost.config	BMS.VI.ServiceHost.exe.config	BMS.ServiceHost.config	
	endpoint		address="http://vaww.bms.va.gov:80/CacheService.svc"  behaviorConfiguration="WindowsClientCredentials" binding="wsFederationHttpBinding" bindingConfiguration="WinBinding" name="BMS.Cache.Windows"  contract="BMS.ServiceContracts.ICacheService"	address="http://<ServerAddress>80/CacheService.svc"  behaviorConfiguration="WindowsClientCredentials"  binding="wsFederationHttpBinding"  bindingConfiguration="WinBinding"  name="BMS.Cache.Windows"  contract="BMS.ServiceContracts.ICacheService"	BMS Web Cache - Client: Windows
	identity\dns		value="IWHM3Services"	value="IWHM3Services"	

Section	Configuration Key/Name	Configuration values (ex.)		Description	
		Split Service		Combine Service	
		BMS.ServiceHost.config	BMS.VI.ServiceHost.exe.config	BMS.ServiceHost.config	
	endpoint		address="https://vaww.bms.va.gov:443/CacheService.svc"  behaviorConfiguration="WindowsClientCredentials" binding="wsFederationHttpBinding"  bindingConfiguration="WinBindingHttps"  name="BMS.Cache.Windows.Https"  contract="BMS.ServiceContracts.ICacheService"	address="https://<servername>.aac.dva.va.gov:443/CacheService.svc"  behaviorConfiguration="WindowsClientCredentials"  binding="wsFederationHttpBinding"  bindingConfiguration="WinBindingHttps"  name="BMS.Cache.Windows.Https"  contract="BMS.ServiceContracts.ICacheService"	BMS Web Cache - Client: Windows
	identity\dns		value="IWHM3Services"	value="IWHM3Services"	

Section	Configuration Key/Name	Configuration values (ex.)		Description	
		Split Service		Combine Service	
		BMS.ServiceHost.config	BMS.VI.ServiceHost.exe.config	BMS.ServiceHost.config	
	endpoint		address="http://<ServerAddress>26:16050/BMSCache"  behaviorConfiguration="ClientCredentialsBehavior"  binding="wsFederationHttpBinding"  bindingConfiguration="WSFederationHttpBinding_AuthenticatedService" name="BMS.BMSCache"  contract="BMS.ServiceContracts.IBedManagerCache"	address="http://localhost:16050/BMSCache"  behaviorConfiguration="ClientCredentialsBehavior"  binding="wsFederationHttpBinding"  bindingConfiguration="WSFederationHttpBinding_AuthenticatedService" name="BMS.BMSCache"  contract="BMS.ServiceContracts.IBedManagerCache"	BMS Cache
	identity\dns		value="IWHM3Services"	value="IWHM3Services"	

Section	Configuration Key/Name	Configuration values (ex.)		Description
		Split Service		Combine Service
		BMS.ServiceHost.config	BMS.VI.ServiceHost.exe.config	BMS.ServiceHost.config
	endpoint		address="http://<ServerAddress>26:16050/BMSCache" behaviorConfiguration="WindowsClientCredentials" binding="wsFederationHttpBinding" bindingConfiguration="WinBinding" contract="BMS.ServiceContracts.IBedManagerCache" name="BMS.BMSCache.Windows"	address="http://localhost:16050/BMSCache" behaviorConfiguration="WindowsClientCredentials" binding="wsFederationHttpBinding" bindingConfiguration="WinBinding" contract="BMS.ServiceContracts.IBedManagerCache" name="BMS.BMSCache.Windows"
	identity\dns		value="IWHM3Services"	value="IWHM3Services"
	behaviors			
	serviceBehaviors			
	behavior	name="ServiceBehavior"		
	serviceMetadata	httpGetEnabled="true"		
	serviceDebug	includeExceptionDetailInFaults="true"		
	dataContractSerializer	type="InfoWorld.Security.Saml20.Saml20ServiceCredentials, Saml20"		
	serviceCredentials	type="InfoWorld.Security.Saml20.Saml20ServiceCredentials, Saml20"		
	serviceCertificate	findValue="IWHM3Services" storeLocation="LocalMachine" storeName="My" x509FindType="FindBySubjectName"		
	issuedTokenAuthentication\knownCertificates\add	findValue="IWHM3STS" storeLocation="LocalMachine" storeName="My" x509FindType="FindBySubjectName"		
	behavior name="WorkflowServi			

Section	Configuration Key/Name	Configuration values (ex.)		Description
		Split Service		Combine Service
		BMS.ServiceHost.config	BMS.VI.ServiceHost.exe.config	BMS.ServiceHost.config
	ce"			
	serviceMetadata httpGetEnabled="true"			
	serviceThrottling		maxConcurrentCalls="1500" maxConcurrentSessions="1500"	maxConcurrentCalls="1000" maxConcurrentSessions="1000"
	serviceDebug		includeExceptionDetailInFaults="true"	includeExceptionDetailInFaults="true"
	serviceCredentials		type="InfoWorld.Security.Saml20.Saml20ServiceCredentials, Saml20"	type="InfoWorld.Security.Saml20.Saml20ServiceCredentials, Saml20"
	serviceCertificate		findValue="IWHM3Services" storeLocation="LocalMachine" storeName="My" x509FindType="FindBySubjectName"	findValue="IWHM3Services" storeLocation="LocalMachine" storeName="My" x509FindType="FindBySubjectName"
	issuedTokenAuthentication\knownCertificates\add		findValue="IWHM3STS" storeLocation="LocalMachine" storeName="My" x509FindType="FindBySubjectName"	findValue="IWHM3STS" storeLocation="LocalMachine" storeName="My" x509FindType="FindBySubjectName"



Section	Configuration Key/Name	Configuration values (ex.)		Description
		Split Service		Combine Service
		BMS.ServiceHost.config	BMS.VI.ServiceHost.exe.config	BMS.ServiceHost.config
	sqlWorkflowInstanceStore		connectionString="DataSource=<DatabaseAddress>;NetworkLibrary=DBMSSOCN;InitialCatalog=BMS_InstanceStore;IntegratedSecurity=True;AsynchronousProcessing=True;Pooling=true;MinPoolSize=0;MaxPoolSize=250;"instanceEncodingOption="None"instanceCompletionAction="DeleteAll"instanceLockedExceptionAction="BasicRetry"hostLockRenewalPeriod="00:00:30"runnableInstancesDetectionPeriod="00:00:02"	connectionString="DataSource=<DatabaseAddress>;InitialCatalog=BMS_InstanceStore;IntegratedSecurity=True;AsynchronousProcessing=True;Pooling=true;MinPoolSize=0;MaxPoolSize=100;"instanceEncodingOption="None"instanceCompletionAction="DeleteAll"instanceLockedExceptionAction="BasicRetry"hostLockRenewalPeriod="00:00:30"runnableInstancesDetectionPeriod="00:00:02"
	workflowIdle		timeToUnload="00:00:00"timeToPersist="00:00:00"	timeToUnload="0"
	sqlWorkflowInstanceStorePromotion		connectionString="DataSource=<DatabaseAddress>;NetworkLibrary=DBMSSOCN;InitialCatalog=BMS_InstanceStore;IntegratedSecurity=True;Pooling=true;MinPoolSize=0;MaxPoolSize=250;"	connectionString="DataSource=<DatabaseAddress>;InitialCatalog=BMS_InstanceStore;IntegratedSecurity=True;Pooling=true;MinPoolSize=0;MaxPoolSize=100;"
	promotionSets			

Section	Configuration Key/Name	Configuration values (ex.)		Description
		Split Service		Combine Service
		BMS.ServiceHost.config	BMS.VI.ServiceHost.exe.config	BMS.ServiceHost.config
	promotionSet name="AdmissionData"		<pre>&lt;promotedValue propertyName="AdmissionId"/&gt; &lt;promotedValue propertyName="PatientName"/&gt; &lt;promotedValue propertyName="LocationName"/&gt;</pre>	<pre>&lt;promotedValue propertyName="AdmissionId"/&gt; &lt;promotedValue propertyName="PatientName"/&gt; &lt;promotedValue propertyName="LocationName"/&gt;</pre>
	promotionSet name="TransferData"		<pre>promotedValue propertyName="PatientSSN"</pre>	<pre>promotedValue propertyName="PatientSSN"</pre>
	behavior name="BasicBindingBehavior"		<pre>&lt;dataContractSerializer maxItemsInObjectGraph="2147483647"/&gt; &lt;serviceDebug includeExceptionDetailInFaults="true"/&gt; &lt;serviceMetadata httpGetEnabled="true"/&gt;</pre>	<pre>&lt;dataContractSerializer maxItemsInObjectGraph="2147483647"/&gt; &lt;serviceDebug includeExceptionDetailInFaults="true"/&gt; &lt;serviceMetadata httpGetEnabled="true"/&gt;</pre>
	endpointBehaviors			
	behavior		name="ClientCredentialsBehavior"	name="ClientCredentialsBehavior"
	dataContractSerializer		maxItemsInObjectGraph="2147483647"	maxItemsInObjectGraph="2147483647"

Section	Configuration Key/Name	Configuration values (ex.)		Description
		Split Service		Combine Service
		BMS.ServiceHost.config	BMS.VI.ServiceHost.exe.config	BMS.ServiceHost.config
	durableIssuedTokenClientCredentials\serviceCertificate		x509FindType="FindBySubjectName" findValue="IWHM3Services" storeName="My" storeLocation="LocalMachine"	x509FindType="FindBySubjectName" findValue="IWHM3Services" storeName="My" storeLocation="LocalMachine"
	authentication		revocationMode="NoCheck"	revocationMode="NoCheck"
	scopedCertificates\add		targetUri="http://<ServerAddress>25:16050/STS/" x509FindType="FindBySubjectName" findValue="IWHM3STS" storeName="My" storeLocation="LocalMachine"	targetUri="http://localhost:16050/STS/" x509FindType="FindBySubjectName" findValue="IWHM3STS" storeName="My" storeLocation="LocalMachine"
	durableIssuedToken		connectionString="Data Source=<DatabaseAddress>;Network Library=DBMSSOCN;Initial Catalog=BMS;Integrated Security=True;Pooling=true;Min Pool Size=0;Max Pool Size=250;" identifier="SessionID"  isolationLevel="ReadCommitted"	connectionString="Data Source=<DatabaseAddress>;Initial Catalog=BMS;Integrated Security=True;Pooling=true;Min Pool Size=0;Max Pool Size=100;" identifier="SessionID"  isolationLevel="ReadCommitted"
	behavior		name="WindowsClientCredentials"	name="WindowsClientCredentials"
	dataContractSerializer		maxItemsInObjectGraph="2147483647"	maxItemsInObjectGraph="2147483647"
	clientCredentials		type="InfoWorld.Security.Authentication.CacheClientCredentials, SecurityTokenCache"	type="InfoWorld.Security.Authentication.CacheClientCredentials, SecurityTokenCache"
	windows		allowNtlm="true"	allowNtlm="true"
	serviceCertificate			

Section	Configuration Key/Name	Configuration values (ex.)		Description
		Split Service		Combine Service
		BMS.ServiceHost.config	BMS.VI.ServiceHost.exe.config	BMS.ServiceHost.config
	defaultCertificate		x509FindType="FindBySubjectName" findValue="IWHM3Services" storeName="My" storeLocation="LocalMachine"	x509FindType="FindBySubjectName" findValue="IWHM3Services" storeName="My" storeLocation="LocalMachine"
	authentication		revocationMode="NoCheck"	revocationMode="NoCheck"
	scopedCertificates\add		targetUri="http://<ServerAddress>25:16050/STS/Windows" x509FindType="FindBySubjectName" findValue="IWHM3STS" storeName="My" storeLocation="LocalMachine"	targetUri="http://localhost:16050/STS/Windows" x509FindType="FindBySubjectName" findValue="IWHM3STS" storeName="My" storeLocation="LocalMachine"
	behavior		name="DataContractSerializer"	name="DataContractSerializer"
	dataContractSerializer		maxItemsInObjectGraph="2147483647"	maxItemsInObjectGraph="2147483647"
	extensions\behaviorExtensions			
	add		name="sqlWorkflowInstanceStorePromotion" type="BMS.Workflows.PropertyPromotionActivity.Configuration.SqlWorkflowInstanceStorePromotionElement, BMS.Workflows.PropertyPromotionActivity"	name="sqlWorkflowInstanceStorePromotion" type="BMS.Workflows.PropertyPromotionActivity.Configuration.SqlWorkflowInstanceStorePromotionElement, BMS.Workflows.PropertyPromotionActivity"

Section	Configuration Key/Name	Configuration values (ex.)		Description
		Split Service		Combine Service
		BMS.ServiceHost.config	BMS.VI.ServiceHost.exe.config	BMS.ServiceHost.config
	add		name="errorHandler" type="BMS.Workflows.CustomActivities.Utils.WFErrorHandlerElement, BMS.Workflows.CustomActivities"	name="errorHandler" type="BMS.Workflows.CustomActivities.Utils.WFErrorHandlerElement, BMS.Workflows.CustomActivities"
	add		name="durableIssuedTokenClientCredentials" type="BMS.Security.Configuration.DurableIssuedTokenClientCredentialsConfigHandler, BMS.Security"	name="durableIssuedTokenClientCredentials" type="BMS.Security.Configuration.DurableIssuedTokenClientCredentialsConfigHandler, BMS.Security"
	log4net			set the level value to ALL or DEBUG in order to trace method entry and exit times
	root	value="OFF"		
	level value	"SQLAppender"		
	appender-ref ref	name="FileAppender" type="log4net.Appender.FileAppender"		
	appender	name="FileAppender" type="log4net.Appender.FileAppender"		
	file	value="log-file.txt"		
	appendToFile	value="true"		
	layout	type="log4net.Layout.PatternLayout"		
	conversionPattern	value="%date [%6thread] -&gt; %message% &lt;-%newline"		
	appender	name="SQLAppender" type="log4net.Async.AsyncAdoNetAppender,log4netAsync"		
	bufferSize	value="1000"		
	connectionType	value="System.Data.SqlClient.SqlConnection, System.Data, Version=1.0.3300.0, Culture=neutral, PublicKeyToken=b77a5c561934e089"		

Section	Configuration Key/Name	Configuration values (ex.)		Description
		Split Service		Combine Service
		BMS.ServiceHost.config	BMS.VI.ServiceHost.exe.config	BMS.ServiceHost.config
	connectionString	value="data source=<DatabaseAddress>;Network Library=DBMSSOCN;initial catalog=BMS_LOG;integrated security=SSPI;persist security info=False;Pooling=true;Min Pool Size=0;Max Pool Size=250;"	value="data source=<DatabaseAddress>;Network Library=DBMSSOCN;initial catalog=BMS_LOG;integrated security=SSPI;persist security info=False;Pooling=true;Min Pool Size=0;Max Pool Size=250;"	value="data source=<DatabaseAddress>;initial catalog=LOG;integrated security=SSPI;persist security info=False;Pooling=true;Min Pool Size=0;Max Pool Size=100;"
	commandText	value="INSERT INTO Log ([Date],[Thread],[Level],[Logger],[Message],[Exception]) VALUES (@log_date, @thread, @log_level, @logger, @message, @exception)"		
	parameter			
	parameterName	value="@log_date"		
	dbType	value="DateTime"		
	layout	type="log4net.Layout.RawTimeStampLayout"		
	parameter			
	parameterName	value="@thread"		
	dbType	value="String"		
	size	value="255"		
	layout	type="log4net.Layout.PatternLayout"		
	conversionPattern	value="%thread"		
	parameter			
	parameterName	value="@log_level"		
	dbType	value="String"		
	size	value="50"		
	layout	type="log4net.Layout.PatternLayout"		
	conversionPattern	value="%level"		
	parameter			
	parameterName	value="@logger"		
	dbType	value="String"		
	size	value="255"		

Section	Configuration Key/Name	Configuration values (ex.)		Description
		Split Service		Combine Service
		BMS.ServiceHost.config	BMS.VI.ServiceHost.exe.config	BMS.ServiceHost.config
	layout	type="log4net.Layout.PatternLayout"		
	conversionPattern	value="%logger"		
	parameter			
	parameterName	value="@message"		
	dbType	value="String"		
	size	value="4000"		
	layout	type="log4net.Layout.PatternLayout"		
	conversionPattern	value="%message"		
	parameter			
	parameterName	value="@exception"		
	dbType	value="String"		
	size	value="2000"		
	layout	type="log4net.Layout.ExceptionLayout"		
	filter	type="log4net.Filter.StringMatchFilter"		do not log messages with durations under 00:00:00.00*
	stringToMatch	value="00:00:00.00"		
	acceptOnMatch	value="false"		
	filter	type="log4net.Filter.StringMatchFilter"		do not log entry messages as they are not relevant duration-wise
	stringToMatch	value="Entry"		
	acceptOnMatch	value="false"		
	startup			
	supportedRuntime	version="v4.6" sku=".NETFramework,Version=v4.6.1"		
	runtime\gcServer	enabled="true"		





Table 5: EIS Service Configuration Parameters

File	Section	Configuration key	Configuration values (ex.)	Description
EISService  Implementation. dll confin	configuration/ connectionStrings/ add	ConnectionString	Workstation id= vadbserver\sql2008r2;packet size=4096;data source= vadbserver sql2008r2;persist security info=False;Initial Catalog=BMS_EIS;Integrated Security=SSPI;	Connection string for the connection to the BMS_EIS database.
		DatasetPath	DBRepository	Data Adapters (XML mapping files) path.
		OverwriteCreateEntityId	true/false	If set to true, the service generates a new unique identifier on each resource create call, otherwise, it uses the identifier received as parameter. If set to true, the service notifies linked
	configuration/ appSettings/ kev	NotificationIndicator	true/false	EIS services of changes produced on entities.
		UseSecurityContext	0/1	ePractice security context
		DnsIdentity	IWHM3Services	Certificate which specifies the service's dns identity.
		ReceiveIndicator	true/false	If set to true, the service accepts notification messages from linked EIS services.
		AutomaticLinkIndicator	true/false	If set to true, entities are automatically linked (associated as equivalent) across linked EIS services.
XEISIndicator	true/false	Specifies whether the cross EIS worker should be started.		
XEISDomain	domain name	Domain of the cross EIS implementation.		

File	Section	Configuration key	Configuration values (ex.)	Description
		SubscriptionTopic	entity	Specifies the topic of the synchronization subscription, meaning what should be synced.
		AuditProtocol	none/udp	Transfer protocol to communicate with the audit service or none if not used.
		AuditServer	auditserver	Server where the audit service resides.
		AuditPort	10000	Port of the audit service on the specified server.
		AuditSynchronIndicator	true/false	Specifies if the Audit Service should be called synchronous or asynchronous.
	configuration/system.serviceModel/behaviors/endpointBehaviors/behavior/clientCredentials/serviceCertificate/scopedCertificates/add	targetUri	http://vaserver:17050/STS/Windows	URI of STS certificate.
	configuration/system.serviceModel/bindings/wsFederationHttpBinding/binding/message/issuerMetadata	address	http://vaserver:17050/STS/mex	STS metadata exchange URL used by ServiceBinding.
	configuration/system.serviceModel/bindings/wsFederationHttpBinding/binding/security/message/issuer	address	http://vaserver:17050/STS/Windows	STS URL used by WinBinding.
	configuration/system.serviceModel/services/service/host/baseAddress/add	baseAddress	http://vaserver:17050/QueryFunctions	EIS Query Functions service endpoint address.
	configuration/system.serviceModel/services/service/host/baseAddress/add	baseAddress	http://vaserver:17050/Administration	EIS Administration service endpoint address.
	configuration/system.serviceMod	baseAddress	http://vaserver:17050/EntityManagement	EIS EntityManagement service endpoint address.

File	Section	Configuration key	Configuration values (ex.)	Description
	el/services/service/host/baseAddress/add			
	configuration/system.serviceModel/services/service/host/baseAddress/add	baseAddress	http://vaserver:17050/ServiceMetadataManagement	EIS ServiceMetadataManagement service endpoint address.
	configuration/system.serviceModel/services/service/host/baseAddress/add	baseAddress	http://vaserver:17050/BulkEntityManagement	EIS Bulk BulkEntityManagement service endpoint address.
	configuration/system.serviceModel/services/service/host/baseAddress/add	baseAddress	http://vaserver:17050/Subscribe	EIS Subscribe service endpoint address.
	configuration/system.serviceModel/services/service/host/baseAddress/add	baseAddress	http://vaserver:17050/LinkAlgorithmAdministration	EIS LinkAlgorithmAdministration service endpoint address.
	configuration/system.serviceModel/services/service/host/baseAddress/add	baseAddress	http://vaserver:17050/EIS/SubscriptionAdministration	EIS SubscriptionAdministration service endpoint address.
	configuration/system.serviceModel/services/service/host/baseAddress/add	baseAddress	http://vaserver:17050/Receive	EIS Receive service endpoint address.
	configuration/system.serviceModel/services/service/host/baseAddress/add	baseAddress	http://vaserver:17050/EIS/MessageAdministration	EIS MessageAdministration service endpoint address.
	configuration/system.serviceModel/services/service/host/baseAddress/add	baseAddress	http://vaserver:17050/EIS/AuthorizationSubscriber	EIS AuthorizationSubscriber service endpoint address.

File	Section	Configuration key	Configuration values (ex.)	Description
	add			
Connections.xml	MyConnections/ connectionString	connectionString	workstation id= vadbserver\sql2008r2;packet size=4096;data source= vadbserver\sql2008r2;persist security info=False;Initial Catalog=BMS_EIS;Integrated Security=SSPI;	Connection string for the connection to the BMS_EIS database.

Table 6 - EVS Service Configuration Parameters

File	Section	Configuration key	Configuration values (ex.)	Description	
MessageImpl.dll. config	configuration/ appSettings/ key	DatasetPath	DBRepository	Data Adapters (XML mapping files) path.	
		ApplicationFolder	D:\CTS\CTSImport	String path to application folder.	
		SqlScriptsFolder	SqlScripts	SQL scripts folder name.	
		TextFilesFolder	TextFiles	Text files folder name.	
		PackageFilesFolder	PackageFiles	Package files folder name.	
		CodeMappingTempTable	dbo.TempMapping	The mapping temporary table name.	
		TemporaryFolder	Temp	Temporary folder name.	
		SubscriptionTopic	cts	Specifies the topic of the synchronization subscription, meaning what should be synced.	
		NotificationIndicator	true/false	Notification indicator.	
		BulkInsertBatchSize	1000	Maximum number of processed records in one step.	
DnsIdentity	IWHM3Services	Certificate which specifies the service's dns identity.			

File	Section	Configuration key	Configuration values (ex.)	Description
		StartSecurityEndpoints	true/false	Specifies if the secure endpoints are to be started.
		http://localhost:17050/CTSImport	EVS	EVS import from excel key.
		http://localhost:17050/CTSExport	EVS	EVS export to excel key.
	configuration/ system.serviceModel/services/serviceHost/baseAddresses/	baseAddress	http://vaserver:17050/ CTSVocabularyRuntime	CTS VocabularyRuntime service endpoint address (HTTP Protocol).
		baseAddress	https://vaserver:17706/	CTS VocabularyRuntime service endpoint address (HTTPS Protocol).

File	Section	Configuration key	Configuration values (ex.)	Description
	add		CTSVocabularyRuntime	
	configuration/ system.serviceModel/services/serviceHost/baseAddresses/ add	baseAddress	http://vaserver:17050/ CTSMapping	CTS Mapping service endpoint address (HTTP Protocol).
		baseAddress	https://vaserver:17706/ CTSMapping	CTS Mapping service endpoint address (HTTPS Protocol).
	configuration/ system.serviceModel/services/serviceHost/baseAddresses/ add	baseAddress	http://vaserver:17050/ CTSVocabularyBrowse	CTS VocabularyBrowse service endpoint address (HTTP Protocol).
		baseAddress	https://vaserver:17706/ CTSVocabularyBrowse	CTS VocabularyBrowse service endpoint address (HTTPS Protocol).
	configuration/ system.serviceModel/services/serviceHost/baseAddresses/ add	baseAddress	http://vaserver:17050/ CTSMMessageRuntime	CTS MessageRuntime service endpoint address (HTTP Protocol).
		baseAddress	https://vaserver:17706/ CTSMMessageRuntime	CTS MessageRuntime service endpoint address (HTTPS Protocol).
	configuration/ system.serviceModel/services/serviceHost/baseAddresses/ add	baseAddress	http://vaserver:17050/ CTSMMessageBrowse	CTS MessageBrowse service endpoint address (HTTP Protocol).
		baseAddress	https://vaserver:17706/ CTSMMessageBrowse	CTS MessageBrowse service endpoint address (HTTPS Protocol).
	configuration/ system.serviceModel/services/serviceHost/baseAddresses/ add	baseAddress	http://vaserver:17050/ CTSMMessageEdit	CTS MessageEdit service endpoint address (HTTP Protocol).
		baseAddress	https://vaserver:17706/ CTSMMessageEdit	CTS MessageEdit service endpoint address (HTTPS Protocol).

File	Section	Configuration key	Configuration values (ex.)	Description
	configuration/ system.serviceModel/services/serviceHost/baseAddresses/add	baseAddress	http://vaserver:17050/ CTSVocabularyEdit	CTS VocabularyEdit service endpoint address (HTTP Protocol).
	configuration/ system.serviceModel/services/serviceHost/baseAddresses/add	baseAddress	https://vaserver:17706/ CTSVocabularyEdit	CTS VocabularyEdit service endpoint address (HTTPS Protocol).
	configuration/ system.serviceModel/services/serviceHost/baseAddresses/add	baseAddress	http://vaserver:17050/ CTSMappingEdit	CTS MappingEdit service endpoint address (HTTP Protocol).
	configuration/ system.serviceModel/services/serviceHost/baseAddresses/add	baseAddress	https://vaserver:17706/ CTSMappingEdit	CTS MappingEdit service endpoint address (HTTPS Protocol).
	configuration/ system.serviceModel/services/serviceHost/baseAddresses/add	baseAddress	http://vaserver:17050/Xaml	XAML service endpoint address.

File	Section	Configuration key	Configuration values (ex.)	Description
	ost/baseAddresses/add			
	configuration/ system.serviceModel/services/serviceHost/baseAddresses/add	baseAddress	http://vaserver:17050/ EVSWrapper	EVS Wrapper service endpoint address.
	configuration/ system.serviceModel/services/serviceHost/baseAddresses/add	baseAddress	http://vaserver:17050/ CTSImport	CTS Import service endpoint address.
	configuration/ system.serviceModel/services/serviceHost/baseAddresses/add	baseAddress	http://vaserver:17050/ CTSExport	CTS Export service endpoint address.
	configuration/ system.serviceModel/services/serviceHost/baseAddresses/add	baseAddress	http://vaserver:17050/ CTSEditBulk	CTS EditBulk service endpoint address.

File	Section	Configuration key	Configuration values (ex.)	Description
	configuration/system.serviceModel/services/service/host/baseAddresses/add	baseAddress	http://vaserver:17050/CTS/SubscriptionAdministration	CTS Subscription Administration service endpoint address.
	configuration/system.serviceModel/services/service/host/baseAddresses/add	baseAddress	http://vaserver:17050/CTS/MessageAdministration	CTS Message Administration service endpoint address.
	configuration/system.serviceModel/bindings/wsFederationHttpBinding/binding/security/message/issuerMetadata	address	http://vaserver:17050/STS/mex	STS metadata exchange URL used by ServiceBinding.

File	Section	Configuration key	Configuration values (ex.)	Description
	configuration/system.serviceModel/bindings/wsFederationHttpBinding/binding/security/message/issuer	address	http://vaserver:17050/STS/Windows	STS URL used by WinBinding.
EVSWrapper.dll.config	configuration/system.serviceModel/services/service/host/baseAddresses/add	baseAddress	http://vaserver:17050/EVSWrapper	EVS Wrapper service endpoint address.

Table 7 - PAP Service Configuration Parameters

File	Section	Configuration key	Configuration values (ex.)	Description	
PolicyAdministration Point.all.config	configuration/ appSettings/	DefaultResourceRoot	VA	Default root for identifiers.	
		DatasetPath	DBRepository	Data Adapters (XML mapping files) path.	
		su	hmcomplus	Specifies the super user of the application.	
		SubscriptionTopic	Authorization	Specifies the topic of the synchronization subscription, meaning what should be synced.	
	key				
		DnsIdentity	IWHM3Services	Certificate which specifies the service's dns identity.	
		AuditProtocol	none/udp	Transfer protocol to communicate with the audit service or none if not used.	
		AuditServer	auditserver	Server where the audit service resides.	
		AuditPort	10000	Port of the audit service on the specified server.	
	configuration/ connectionStrings/ add	connectionString	workstation id= vadbserver\sql2008r2;packet size=4096;data source= vadbserver\sql2008r2;persist security info=False;Initial Catalog=BMS_AUTHZ;Integrated Security=SSPI;	Connection string for the connection to the BMS_AUTHZ database.	
configuration/syste m.serviceModel/ bindings/ wsFederationHttpBi nding/binding/securi ty/message/issuer	address	http://vaserver:17050/STS/ Windows	STS URL used by UpnBinding.		



File	Section	Configuration key	Configuration values (ex.)	Description
	configuration/system.serviceModel/bindings/wsFederationHttpBinding/binding/security/message/issuer	address	http://vaserver:17050/STS/Windows	STS URL used by WinBinding.
	configuration/system.serviceModel/services/service/host/baseAddresses/add	baseAddress	http://vaserver:17050/PAP	PAP service endpoint address.
	configuration/system.serviceModel/services/service/host/baseAddresses/add	baseAddress	http://vaserver:17050/AuthorizationPublisher	AuthorizationPublisher service endpoint address.
	configuration/system.serviceModel/services/service/host/baseAddresses/add	baseAddress	http://vaserver:17050/PAP/MessageAdministration	MessageAdministration service endpoint address.
	configuration/system.serviceModel/services/service/host/baseAddresses/add	baseAddress	http://vaserver:17050/PAP/SubscriptionAdministration	SubscriptionAdministration service endpoint address.
	configuration/system.serviceModel/client/endpoint	address	http://vaserver:17050/PDP/Request	PDP request client endpoint address.
	configuration/system.serviceModel/behaviors/endpointBehaviors/behavior/clientCredentials/serviceCertificate/scopedCertificates/add	targetUri	http://vaserver:17050/STS/Windows	URI of STS certificate.
Connections.xml	MyConnections/MyConnection/	connectionString	workstation id= vadbserver\sql2008r2;packet	Connection string for the connection to the BMS_AUTHZ database.

File	Section	Configuration key	Configuration values (ex.)	Description
	ConnectionString		size=4096;data source=vadserver\sql2008r2;persist security info=False;Initial Catalog=BMS_AUTHZ;Integrated Security=SSPI;	

Table 8 - PDP Service Configuration Parameters

File	Section	Configuration key	Configuration values (ex.)	Description
PolicyDecisionPoint.dll.config	configuration/ appSettings/ key	DefaultResourceRoot  ConnectionString	VA  Data source=vadbserver\sql2008; InitialCatalog=BMS_AUTHZ;Persi st Security Info=False;Integrated Security=SSPI	Default root for identifiers.  Connection string for the connection to the BMS_AUTHZ database.
	configuration/  system.serviceMod el/bindings/ wsFederationHttpBi nding/binding/securi ty/message/issuerM etadata	address	http://vaserver:17050/STS/mex	STS metadata exchange URL used by ServiceBinding.
	configuration/ system.serviceMod el/services/service/h ost/baseAddresses/ add	baseAddress	http://vaserver:17050/PDP	PDP service endpoint address.
	configuration/ system.serviceMod el/services/service/h ost/baseAddresses/ add	baseAddress	http://vaserver:17050/PDP/ Request	PDP Request service endpoint address.

Table 9 - RS Service Configuration Parameters

File	Section	Configuration key	Configuration values (ex.)	Description
RS.Service Implementation.	configuration/ appSettings/	DefaultResourceRoot	VA	Default root for identifiers.
		ReportingServicesURL	http://vaserver:90/Report	Reporting services URL address.
dll.config	key		Server/ReportService2005. asmx	
		RootFolderName	Reporting Service	Reports root folder in the reporting services.
		AuditProtocol	none/udp	Transfer protocol to communicate with the audit service or none if not used.
		AuditServer	auditserver	Server where the audit service resides.
		AuditPort	10000	Port of the audit service on the specified server.
	configuration/system.serviceModel/client/endpoint	address	http://vaserver:17050/PDP/Request	PDP request client endpoint address.
	configuration/system.serviceModel/bindings/wsFederationHttpBinding/binding/security/message/issuerMetadata	address	http://vaserver:17050/STS/mex	STS metadata exchange URL used by ServiceBinding.
	configuration/system.serviceModel/bindings/wsFederationHttpBinding/binding/security/message/issuer	address	http://vaserver:17050/STS/Windows	URL of CustomBinding_IAuthenticationService.
	configuration/system.serviceModel/services/service/host/baseAddresses/add	baseAddress	http://vaserver:17050/RS	RS service endpoint address.

File	Section	Configuration key	Configuration values (ex.)	Description
	configuration/ system.serviceModel/behaviors/ endpointBehaviors/ behavior/ clientCredentials/ serviceCertificate/ scopedCertificates/add	targetUri	http://vaserver:17050/STS/ Windows	URI of STS certificate.

Table 10 - STS Service Configuration Parameters

File	Section	Configuration key	Configuration values (ex.)	Description	
SecureToken	configuration/ appSettings/ key	Delay	0:01:00	Sleep interval between the retries to insert the superusers in the database.	
		TokenTTLInMinutes	1442	Time to live of the security token, in minutes.	
		STSCertificateStoreName	My	Specifies the name of the X.509 certificate store to open.	
		STSCertificateStoreLocation	LocalMachine	Specifies the location of the X.509 STS certificate store.	
		STSCertificateFindType	FindBySubjectName	Specifies the type of value the X509Certificate2Collection.Find method	
					searches for.
		STSCertificateFindValue	IWHM3STS	STS Certificate name.	
		ServiceCertificateStoreName	My	Specifies the name of the X.509 certificate store to open.	
		ServiceCertificateStoreLocation	LocalMachine/CurrentUser	Specifies the location of the X.509 services' certificate store.	

File	Section	Configuration key	Configuration values (ex.)	Description
Service.dll.config		ServiceCertificateFindType	FindBySubjectName	Specifies the type of value the X509Certificate2Collection.Find method searches for.
		ServiceCertificateFindValue	IWHM3Services	Services' Certificate name.
		su	Domain qualified user names, comma separated.	Usernames of all the super users in the application.
		domains	VA VA	Comma separated list of root extension values for the application's domains.
	configuration/connectionStrings/add	connectionString	workstation id=vadbserver\sql2008r2;packet size=4096;data source=vadbserver\sql2008;persist security info=False;Initial Catalog=BMS_AUTHZ;Integrated Security=SSPI;	Connection string for the connection to the BMS_AUTHZ database.
configuration/system.serviceModel/services/service/host/baseAddresses/add	baseAddress	http://vaserver:17050/STS	STS service endpoint address.	
	configuration/system.serviceModel/services/service/	baseAddress	http://vaserver:17050/authsvc	Authsvc service endpoint address.
	configuration/system.serviceModel/bindings/wsFederationHttpBinding/binding/security	address	http://vaserver:17050/STS/mex	STS metadata exchange URL used by ServiceBinding.
	configuration/system.serviceModel/bindings/wsFederationHttpBinding/binding/security/message/issuer	address	http://vaserver:17050/STS/Windows	URL of STS used by WindowsBinding.

File	Section	Configuration key	Configuration values (ex.)	Description
	configuration/ system.serviceModel/bindings/ wsFederationHttpBinding/binding/security/message/issuer/identity/userPrincipalName	value	VAUser@domain.com	Name of the user under which the service is running.
	configuration/ system.serviceModel/behaviors/serviceBehaviors/behavior/serviceMetadata	httpGetUrl	http://vaserver:17050/STS/mex	Metadata exchange address of ServiceSTSBehavior.

Table 11 - Win ServiceHost Configuration Parameters

File	Section	Configuration key	Configuration values (ex.)	Description
WinServiceHost.exe.config	configuration/appSettings/key	LocalServer	yes/no	ePractice remoting flag. Only used with yes.
		UseSecurityContext	0/1	Flag which specifies if ePractice uses the security context.
		AuditProtocol	none/udp	Transfer protocol to communicate with the audit service or none if not used.
		ServiceStartupTimeoutSecondsAdd	90	Time in seconds to wait for the services to start
		AuditServer	auditserver	Server where the audit service resides.
		AuditPort	10000	Port of the audit service on the specified server.
		ServiceCertificateStoreName	My	Specifies the name of the X.509 certificate store to open.
		ServiceCertificateStoreLocation	LocalMachine	Specifies the location of the X.509 services' certificate store.
		ServiceCertificateFindType	FindBySubjectName	Specifies the type of value the X509Certificate2Collection.Find method searches for.
		ServiceCertificateFindValue	IWHM3Services	Services' Certificate name.



Table 12 - WMI User Group Configuration Parameters

File	Section	Configuration key	Configuration values (ex.)	Description
WMI_UserGroup.exe	configuration/ appSettings/ key	DatasetPath	DBRepository	Data Adapters (XML mapping files) path.
		LocalMachineName	localhost	Name of the host where WMI_UserGroup will run.
		IsRunningOnLocalMachine	true/false	Specify if WMI_UserGroup will run on local machine or not.
Connections.xml	MyConnections/ MyConnection/ ConnectionString	ConnectionString	packet size=4096;data source= vadbserver\sql2008r2;persist security info=False;Initial Catalog=BMS_DW;Integrated Security=SSPI;connection timeout = 600	Connection string for the connection to the BMS_DW database.

Table 13 - Policy Manager Configuration Parameters

File	Section	Configuration key	Configuration values (ex.)	Description
	configuration/ appSettings/ key	DefaultResourceRoot	VA	Default root for identifiers.
		AuditProtocol	none/udp	Transfer protocol to communicate with the audit service or none if not used.
		AuditServer	auditserver	Server where the audit service resides.
		AuditPort	10000	Port of the audit service on the specified server.
	configuration/			
	system.serviceModel/bindings/wsFederationHttpBinding/binding/security/message/issuer	address	http://vaserver:17050/STS/	STS address used by wsFederationBinding binding

File	Section	Configuration key	Configuration values (ex.)	Description
PolicyManager.exe.config	configuration/system.serviceModel/behaviors/endpointBehaviors/behavior/clientCredentials/scopedCertificates/add	targetUri	http://vaserver:17050/STS/	STS address of STS certificate.
	configuration/system.serviceModel/client/endpoint	address	http://vaserver:17050/PAP	PAP client endpoint address.
	configuration/system.serviceModel/client/endpoint	address	http://vaserver:17050/AuthorizationPublisher	AuthorizationPublisher client endpoint address.
PolicyEditor.dll.config	configuration/system.serviceModel/client	address	http://vaserver:17050/PAP	PAP client endpoint address.

Table 14 - BMS Web Configuration Parameters

File	Section	Configuration key	Configuration values (ex.)	Description
Web.config	configuration/appSettings/	webpages:Version	1.0.0.0	Version of the web site.
		ClientValidationEnabled	true/false	Gets or sets a value that indicates whether client-side validation is enabled.
	key	UnobtrusiveJavaScriptEnabled	true/false	Gets or sets a value that indicates whether unobtrusive JavaScript is enabled.
		ReportsPath	/BMS	Path of the reports in the reporting services.
		BMS.EVSDictionaryCacheSize	512	Cache size for the vocabulary service, representing the number of concepts cached.
		VAURL	http://vaww.esm.infoshare.va.gov/PMIC/Projects/BMS/Implement/default.aspx	BMS Sharepoint Site.

File	Section	Configuration key	Configuration values (ex.)	Description
		TICKETURL	http://vaww.esm.infoshare.va.gov/PMIC/Projects/BMS/Implement/HDPProcess/default.aspx	Enter a defect and enhancement ticket.
		WhiteboardRefreshRate	60	Time in seconds of refresh rate of the whiteboard page.
		THRESHOLD	0	Threshold value used to compare wait time value of the patient from the Patients Pending Placement List in order to display an alert on the Patients Pending Placement List.
		aspnet:MaxHttpCollectionKeys	2000	Maximum number of aps.net collection keys.
		WhiteboardAjaxRefreshRate	180	Time in seconds of AJAX refresh rate of the whiteboard page.
		WhiteboardRealRefreshRate	60	Time in minutes of standard refresh rate of the whiteboard page.
		HomePageRefreshRate	300	Time in seconds of refresh rate of the home page.
		BMS_EIS_GET_ENTITY_FILTR_PAGE_SIZE	1000	Number of records queried that are brought from EIS in one page.
		BMS_EVS_GET_CONCEPT_PAGE_SIZE	1000	Number of records queried that are brought from EVS in one page.
		Smtphost	VA_MAIL_SERVER	Mail Server host.
		DisplayDetailedErrorMessage	true/false	If set to true displays detailed error message, otherwise displays a generic message ("Please contact BMS administrator.")

File	Section	Configuration key	Configuration values (ex.)	Description
		Is_IIS_Single_Instance	true/false	If set to true a single IIS instance is used. If set to false multiple IIS instances are used (web farm scenario).
		ProxyPoolMaxCount	100	The maximum number of proxies in the pool.
		MdwsEndpointUrl_1	http://mdws_server:81/QuerySvc.asmx	MDWS instance URL address.
		MdwsEndpointUrl_2	http://mdws_server:82/QuerySvc.asmx	MDWS instance URL address.

File	Section	Configuration key	Configuration values (ex.)	Description
	configuration/system.serviceModel/bindings/wsFederationHttpBinding/binding/security/message/issuer	address	http://vaserver:17050/STS/Windows	STS Windows address used by WindowsBinding.
	configuration/system.serviceModel/bindings/wsFederationHttpBinding/binding/security/message/issuer	address	http://vaserver:17050/STS/	STS address used by WSFederationHttpBinding_Authenticated Service binding.
	configuration/system.serviceModel/client/endpoint	address	http://vaserver:17050/authsvc/upnidentity	Security Authentication client endpoint address.
	configuration/system.serviceModel/client/endpoint	address	http://vaserver:17050/RS	Reporting Services client endpoint address.
	configuration/system.serviceModel/client/endpoint	address	http://vaserver:17050/QueryFunctions	EIS QueryFunctions client endpoint address.
	configuration/system.serviceModel/client/endpoint	address	http://vaserver:17050/QueryFunctions	EIS QueryFunctions Windows authentication client endpoint address.
	configuration/system.serviceModel/client/endpoint	address	http://vaserver:17050/EntityManagement	EIS EntityManagement client endpoint address.
	configuration/system.serviceModel/client/endpoint	address	http://vaserver:17050/EntityManagement	EIS EntityManagement Windows authentication client endpoint address.

File	Section	Configuration key	Configuration values (ex.)	Description
	client/endpoint			
	configuration/system.serviceModel/client/endpoint	address	http://vaserver:17050/PAP	PAP client endpoint address.
	configuration/system.serviceModel/client/endpoint	address	http://vaserver:17050/PAP	PAP Windows authentication client endpoint address.

File	Section	Configuration key	Configuration values (ex.)	Description
	configuration/system.serviceModel/client/endpoint	address	http://vaserver:17050/PDP	PDP client endpoint address.
	configuration/system.serviceModel/client/endpoint	address	http://vaserver:17050/PDP	PDP Windows authentication client endpoint address.
	configuration/system.serviceModel/client/endpoint	address	http://vaserver:17050/CTSVocabularyRuntime	CTS VocabularyRuntime client endpoint address.
	configuration/system.serviceModel/client/endpoint	address	http://vaserver:17050/CTSVocabularyBrowse	CTS VocabularyBrowse client endpoint address.
	configuration/system.serviceModel/client/endpoint	address	http://vaserver:17050/CTSMessageBrowse	CTS MessageBrowse client endpoint address.
	configuration/system.serviceModel/client/endpoint	address	http://vaserver:17050/CTSMessageRuntime	CTS MessageRuntime client endpoint address.
	configuration/system.serviceModel/client/endpoint	address	http://vaserver:17050/CTSMessageEdit	CTS MessageEdit client endpoint address.
	configuration/system.serviceModel/client/endpoint	address	http://vaserver:17050/CTSVocabularyEdit	CTS VocabularyEdit client endpoint address.
	configuration/system.serviceModel/client/endpoint	address	http://vaserver:17050/BMSConfigurationOperations	BMS ConfigurationOperations client endpoint address.
	configuration/system.serviceModel/client/endpoint	address	http://vaserver:17050/BMSConfigurationOperations	BMS ConfigurationOperations Windows authentication client endpoint address.

File	Section	Configuration key	Configuration values (ex.)	Description
	configuration/system.serviceModel/client/endpoint	address	<i>http://vaserver:17050/BMSQuery</i>	BMS Query client endpoint address.
	configuration/system.serviceModel/client/endpoint	address	<i>http://vaserver:17050/BMSOperations</i>	BMS Operations client endpoint address.
	configuration/system.serviceModel/client/endpoint	address	<i>http://vaserver:17050/TransferWF</i>	Transfer workflow client endpoint address.
	configuration/system.serviceModel/client/endpoint	address	<i>http://vaserver:17050/BMSWF</i>	BMS workflow client endpoint address.
	configuration/system.serviceModel/client/endpoint	address	<i>http://vaserver:17050/WaitingListWF</i>	Patients Pending Placement List workflow client endpoint address.
	configuration/system.serviceModel/client/endpoint	address	<i>http://vaserver:17050/BedCleanWF</i>	Bed clean workflow client endpoint address.
	configuration/system.serviceModel/client/endpoint	address	<i>http://vaserver:17050/BedUnavailableWF</i>	Bed Unavailable workflow client endpoint address.
	configuration/system.serviceModel/client/endpoint	address	<i>http://vaserver:17050/VistaQuery</i>	Vista Query client endpoint address.
	configuration/system.serviceModel/client/endpoint	address	<i>http://vaserver:17050/VistaQuery</i>	Vista Query Windows authentication client endpoint address.

# 2.4 Scheduled Windows and SQL Jobs Configuration

BMS runs one Windows Scheduled task: BMS – WMI\_UserGroup and two SQL Jobs in order to bring data into the data warehouse (BMS\_DW database): BMS - Reports Full and BMS – Reports Incremental. More information about BMS databases can be referenced from [Section 3.3](#).

## 2.4.1 BMS Reports Full

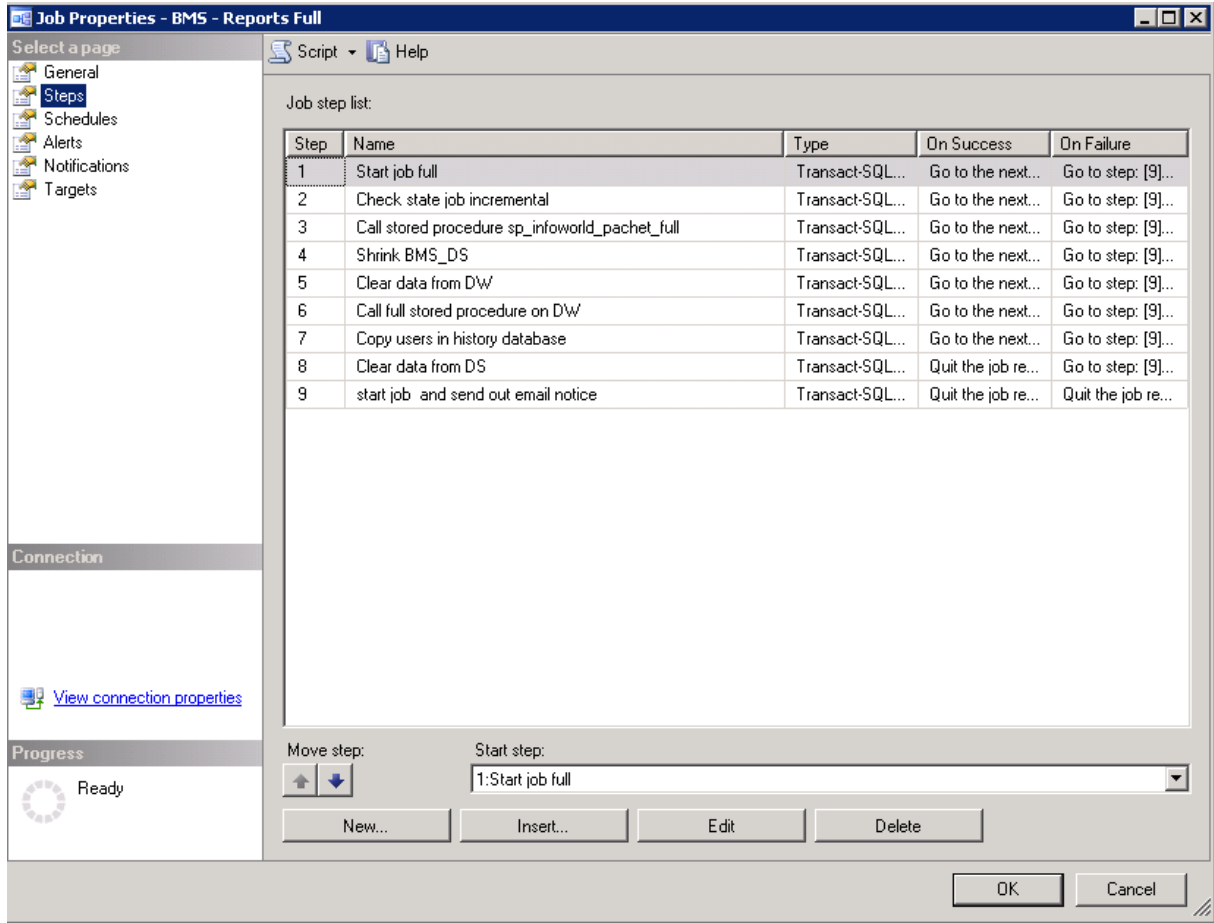
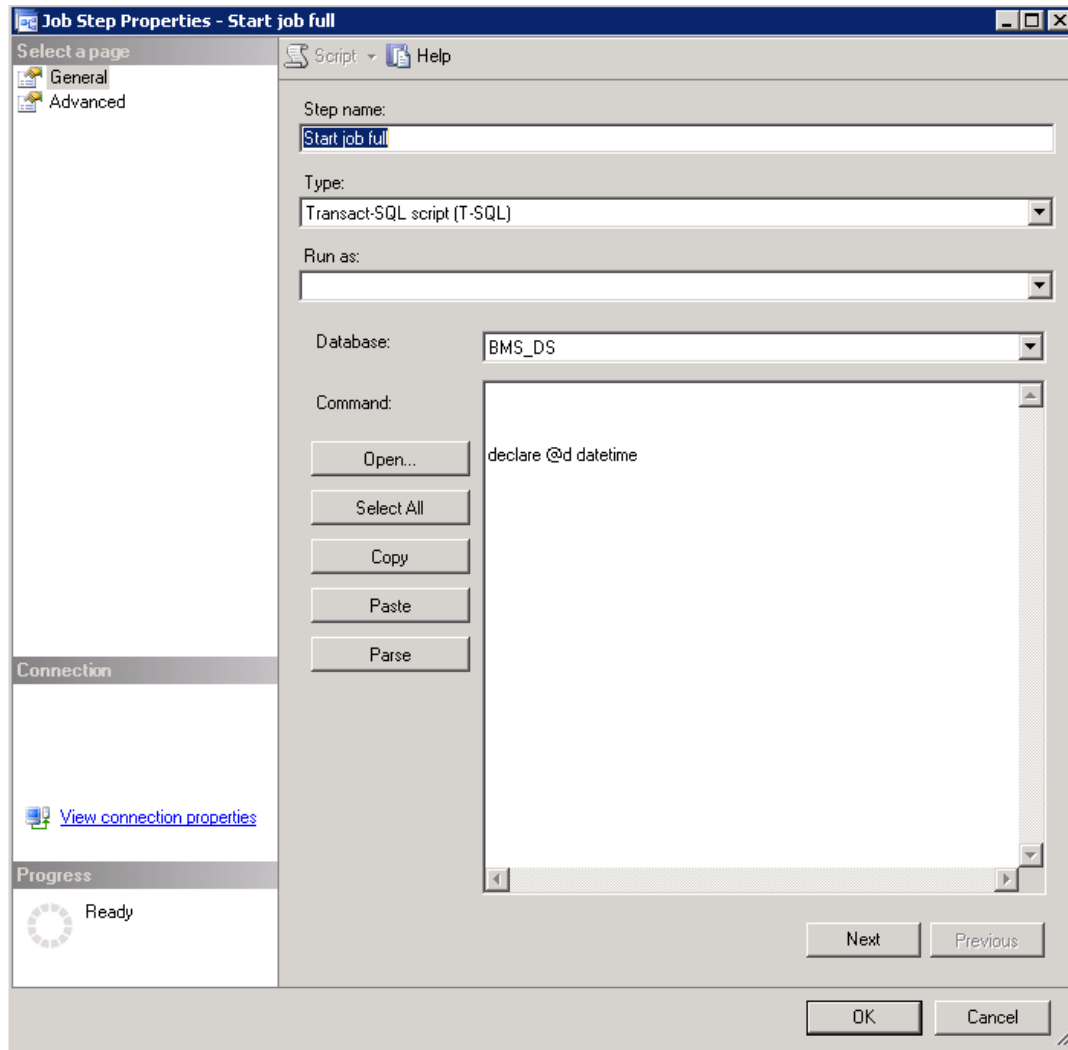

Figure 2 - BMS - Report Full Job

The job’s steps can be seen in the figure above and most of them execute stored procedures. At the beginning of the process, the operations are done between the source databases and the destination database, which is BMS\_DS in our case.

Each step is described below:

**Step 1.** Start job full: this is only an informative step for the log file.



*Figure 3 - BMS - Start Full Job*

**Step 2.** Check state job incremental: it checks the state of the BMS incremental job in order to be sure that it is not currently running, in which case the full job cannot continue.



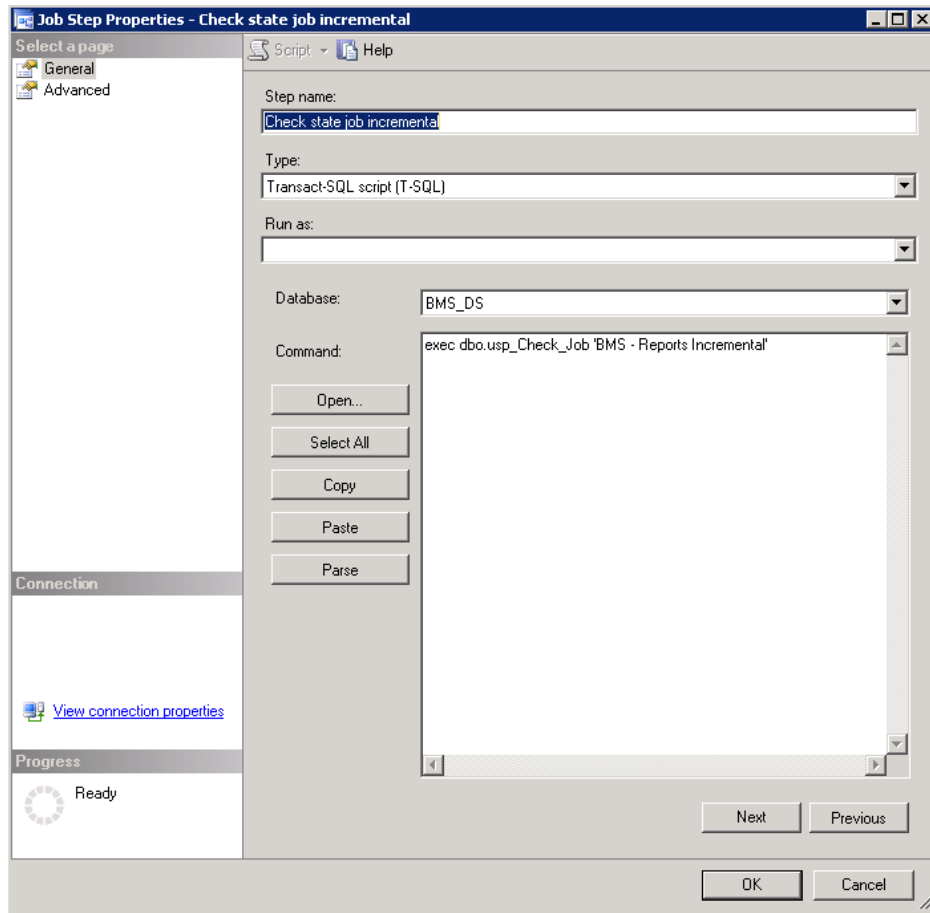

*Figure 4 - BMS - Check State Job Incremental*

**Step 3.** Call procedure `sp_infoworld_pachet_full`: creates or truncates the existing tables in the destination database and then inserts all the rows from each source table in the corresponding destination table. The destination tables from BMS\_DS have the same name as the source tables but prefixed with the source database name. This information is stored in a configuration table in BMS\_DS database, `dbo.ConfigTable`.

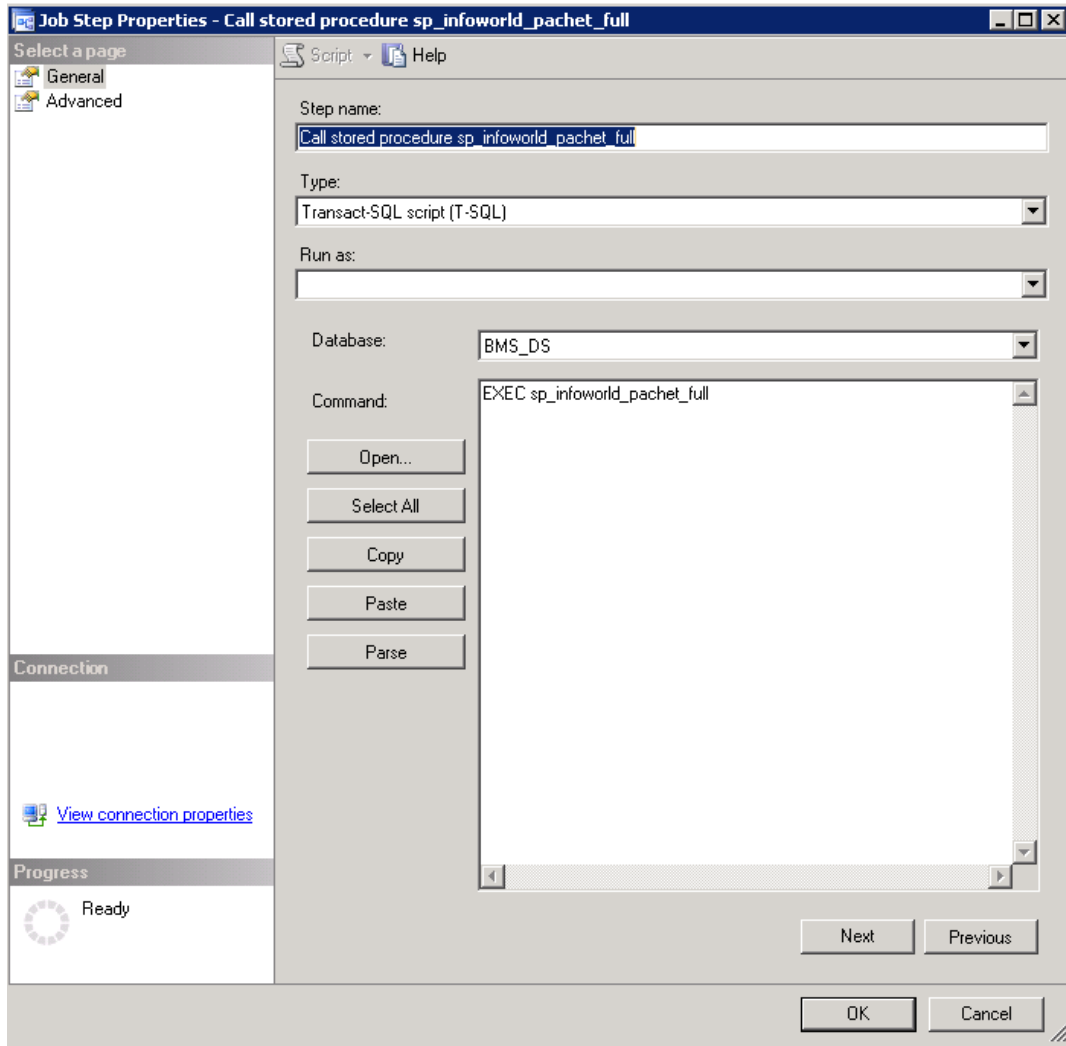

*Figure 5 - BMS - Call Procedure*

**Step 4. Shrink BMS\_DS:** Shrinks the file with the id 2 (the log file), to the size of 1 MB.

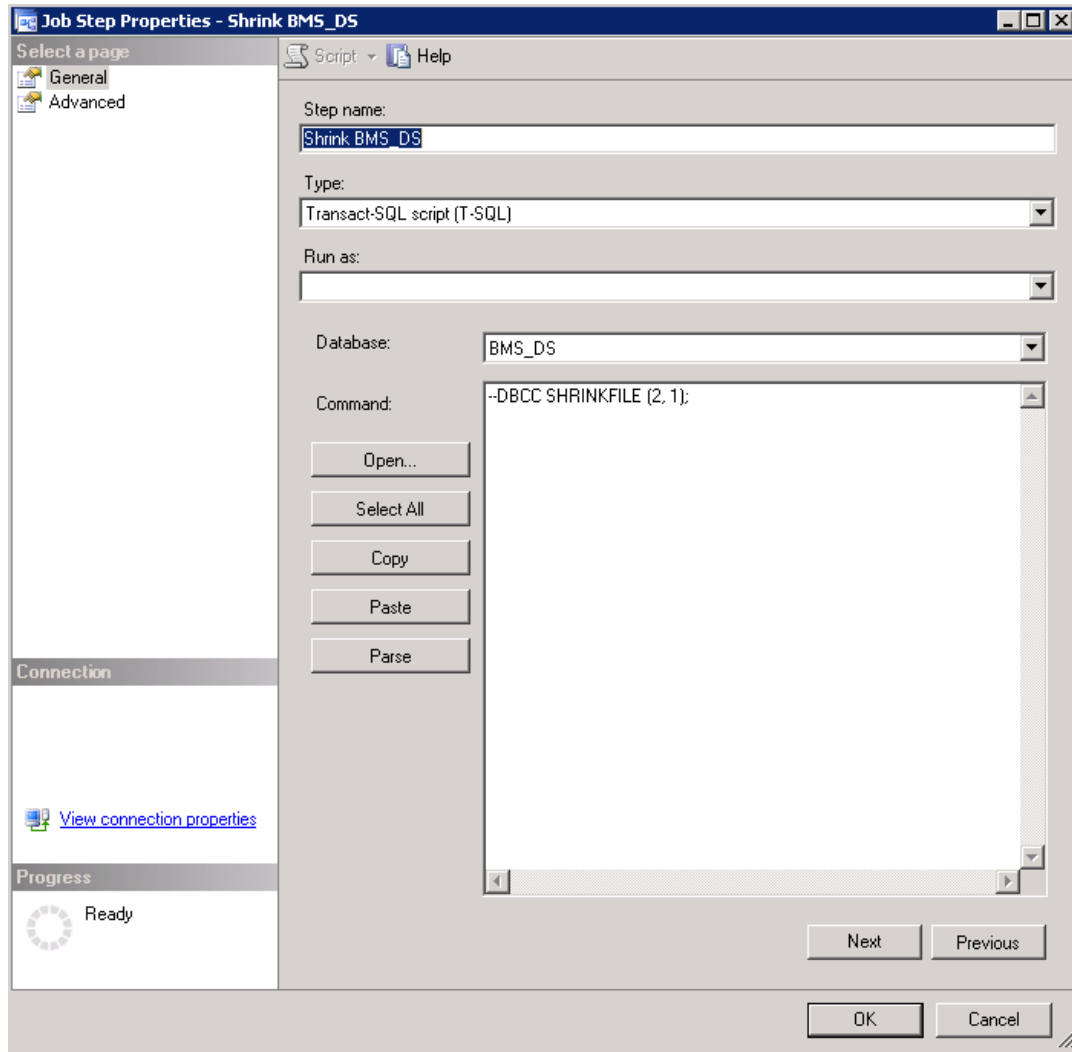

*Figure 6 - BMS - Shrink*

**Step 5.** Clear data from BMS\_DW: the data warehouse database is cleared, meaning that its tables will become empty, but of course exceptions can exist and they really do - tables that contain static data and should not be removed. Thus, the database becomes ready to receive all the source data.

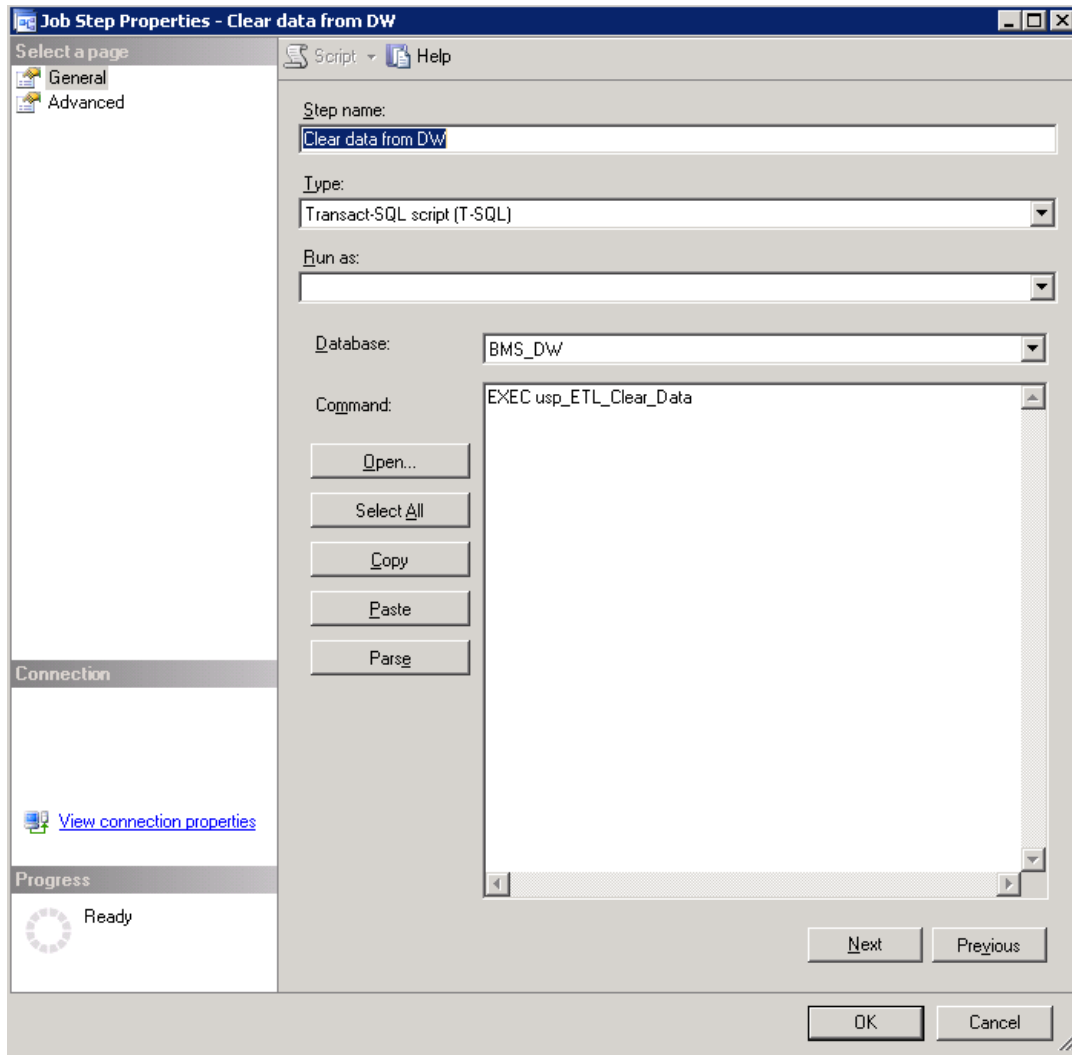

*Figure 7 - BMS - Clear Data*

**Step 6.** Call procedure full on BMS\_DW: it inserts first the vocabulary data, then EIS entities (ETL dimension tables) and BMS acts (ETL facts tables).

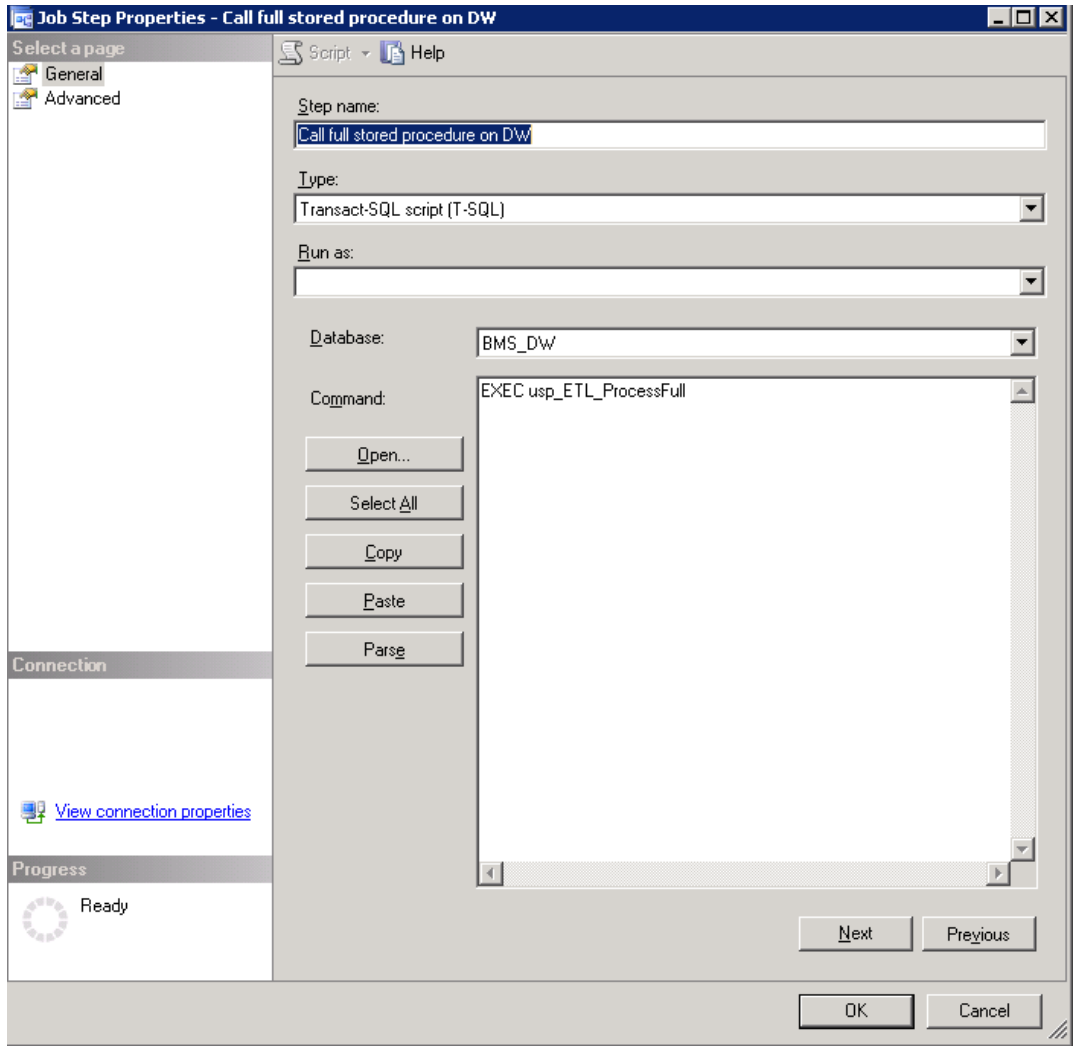

*Figure 8 - BMS - Call Procedure Full*

**Step 7.** Copy users in history database: adds users in user\_h table from BMS History database. This step is needed because some reports need to display users that did certain insert/update/delete operations in the application.

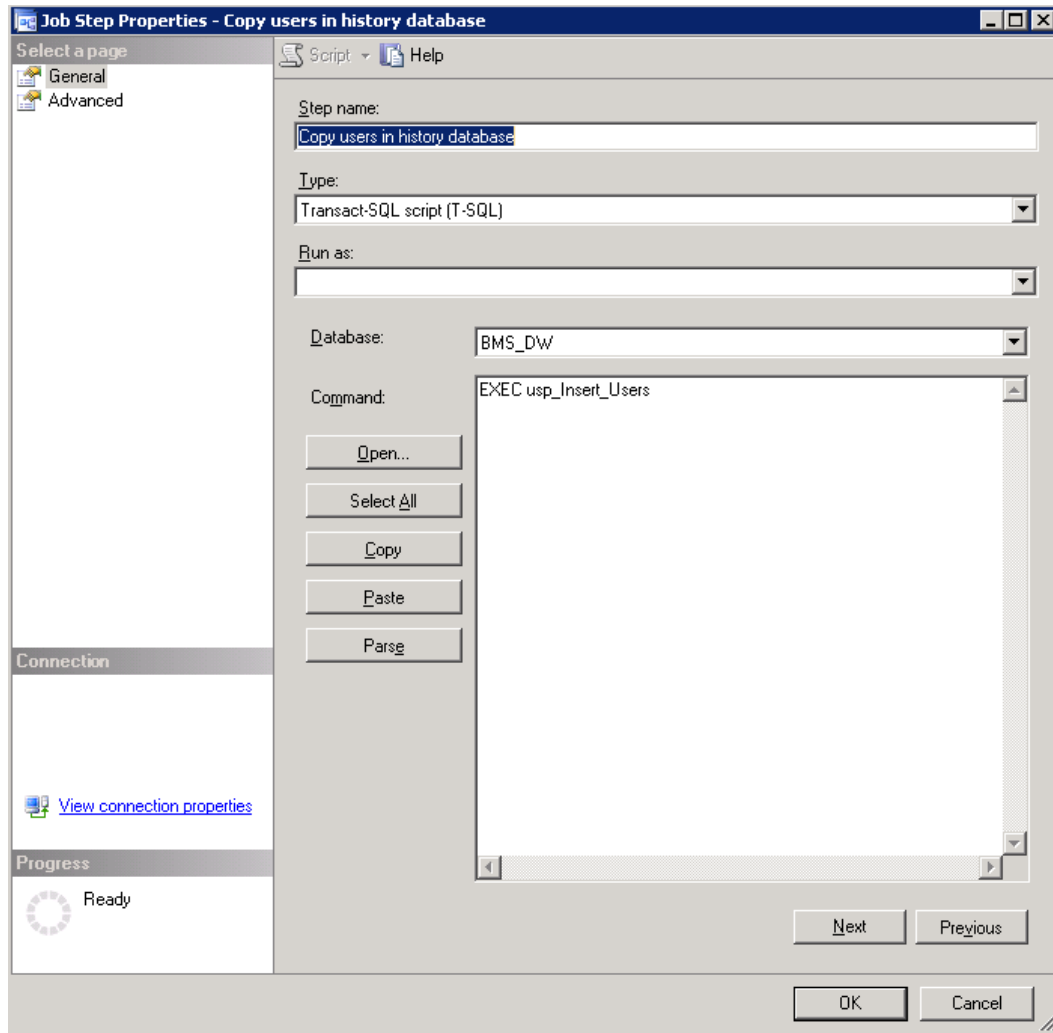

*Figure 9 - Copy Users in History Database*

For each step a log file can be set, see screenshot below for step 7:

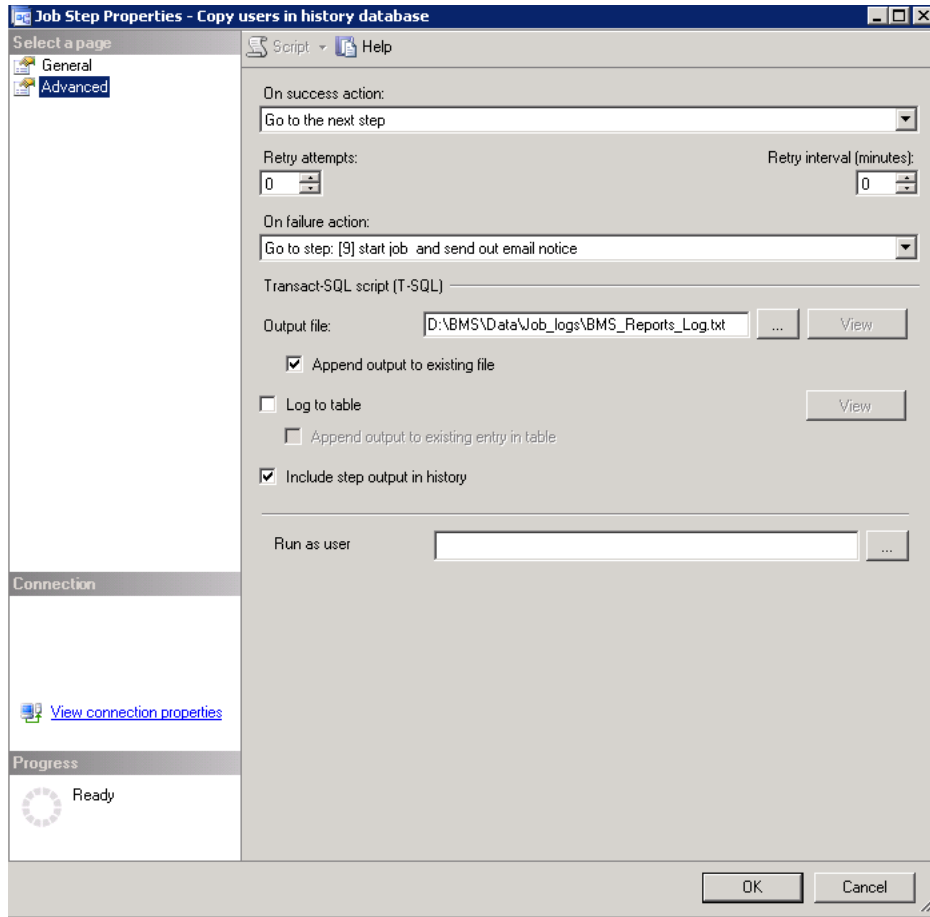
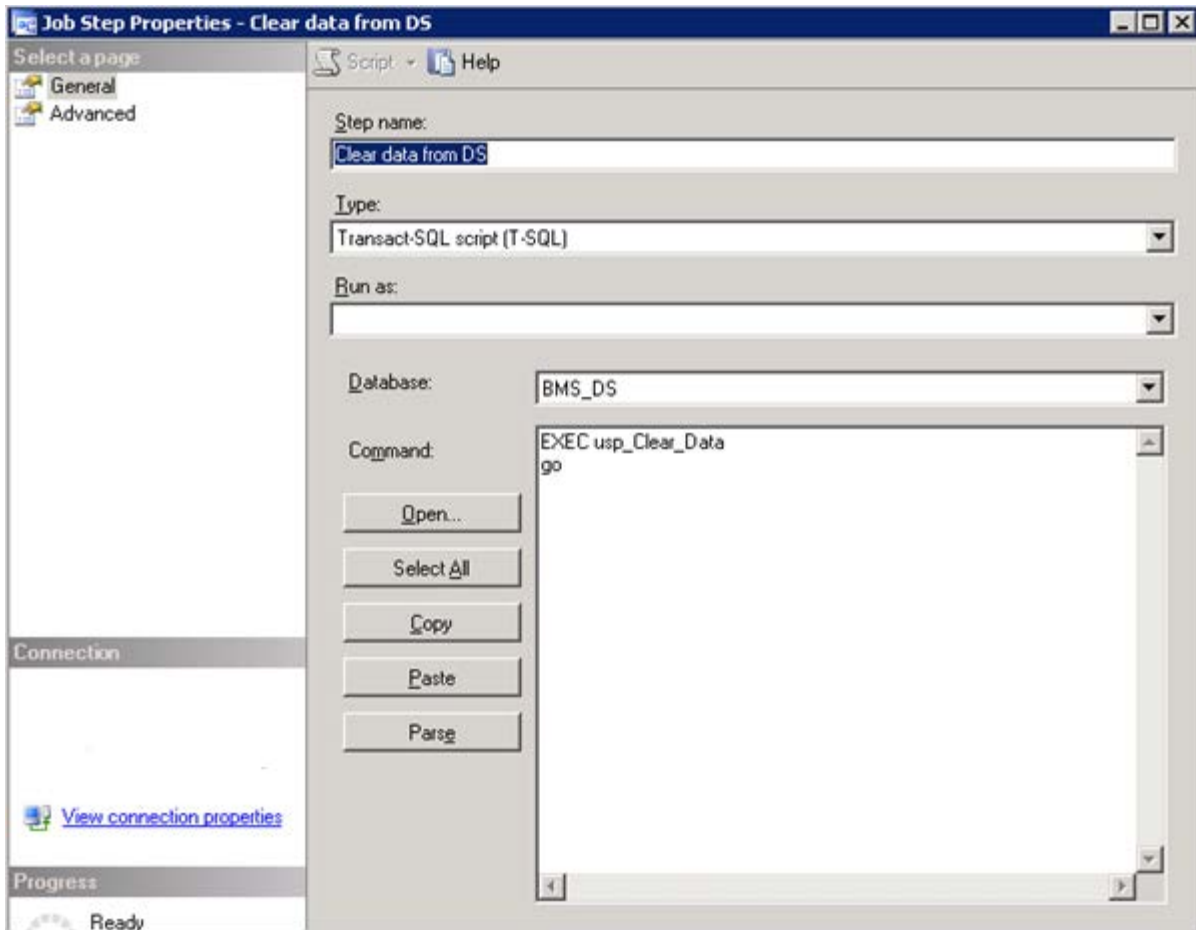

Figure 10 - BMS Reports Full Path File Log

The job can be run by right clicking on the job and then choosing “Start job at step...”, selecting the first job in the appearing window and then hitting the Start button. Then a smaller window remains open, showing the progress of the execution and its result: success or failure. The detailed results can be found in the log file that you set at the installation phase. If an operation fails at any step, the job will quit. This setting can be changed in the step’s *Advanced* tab.

**Step 8.** Clear data from BMS DS database.



**Step 9.** This step is only invoked if any of the prior steps of the BMS Report Full job fail. Once invoked, email notification of the failure is sent to the BMS Technical team and BMS Report Full job is restarted.



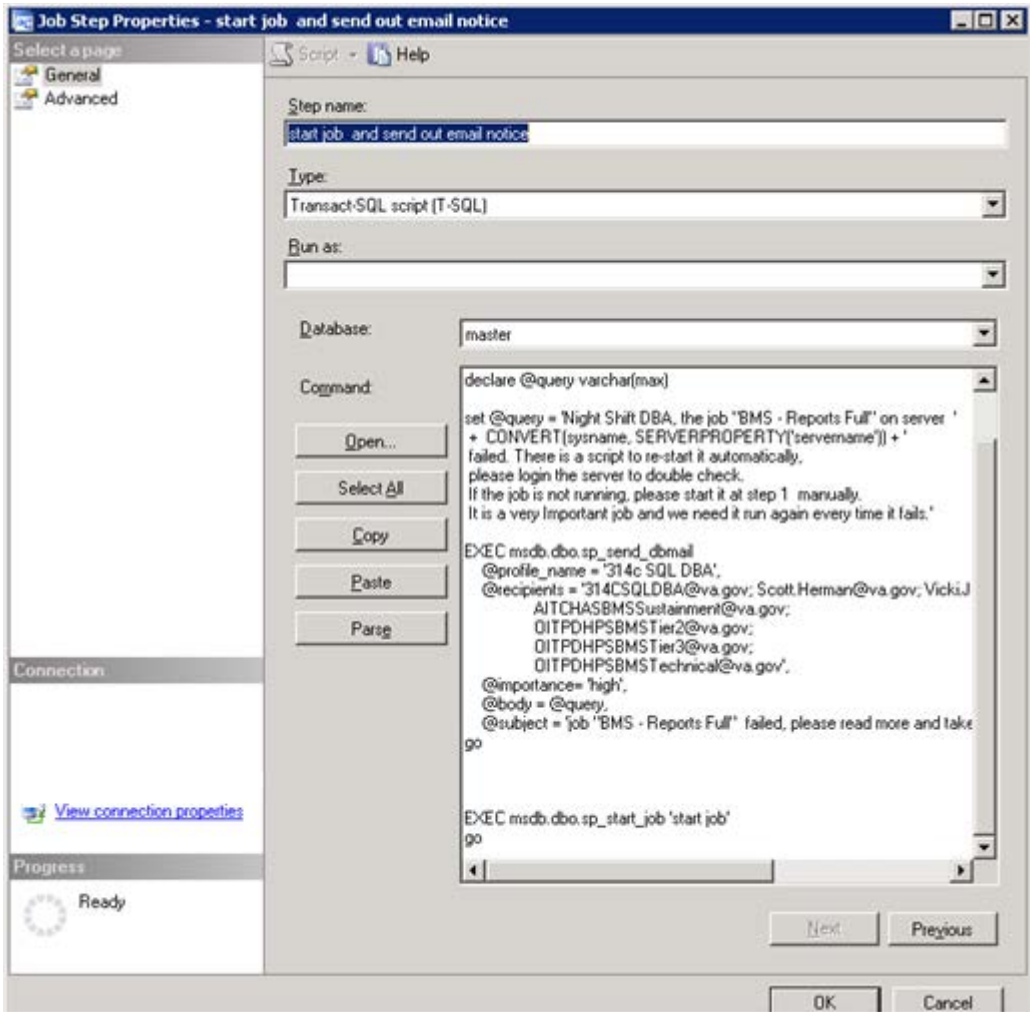

## 2.4.2

### Incremental

**BMS**

BMS Incremental logic is to keep the BMS\_DW database up to date without having to delete all the existing data. The following picture shows the job's steps.

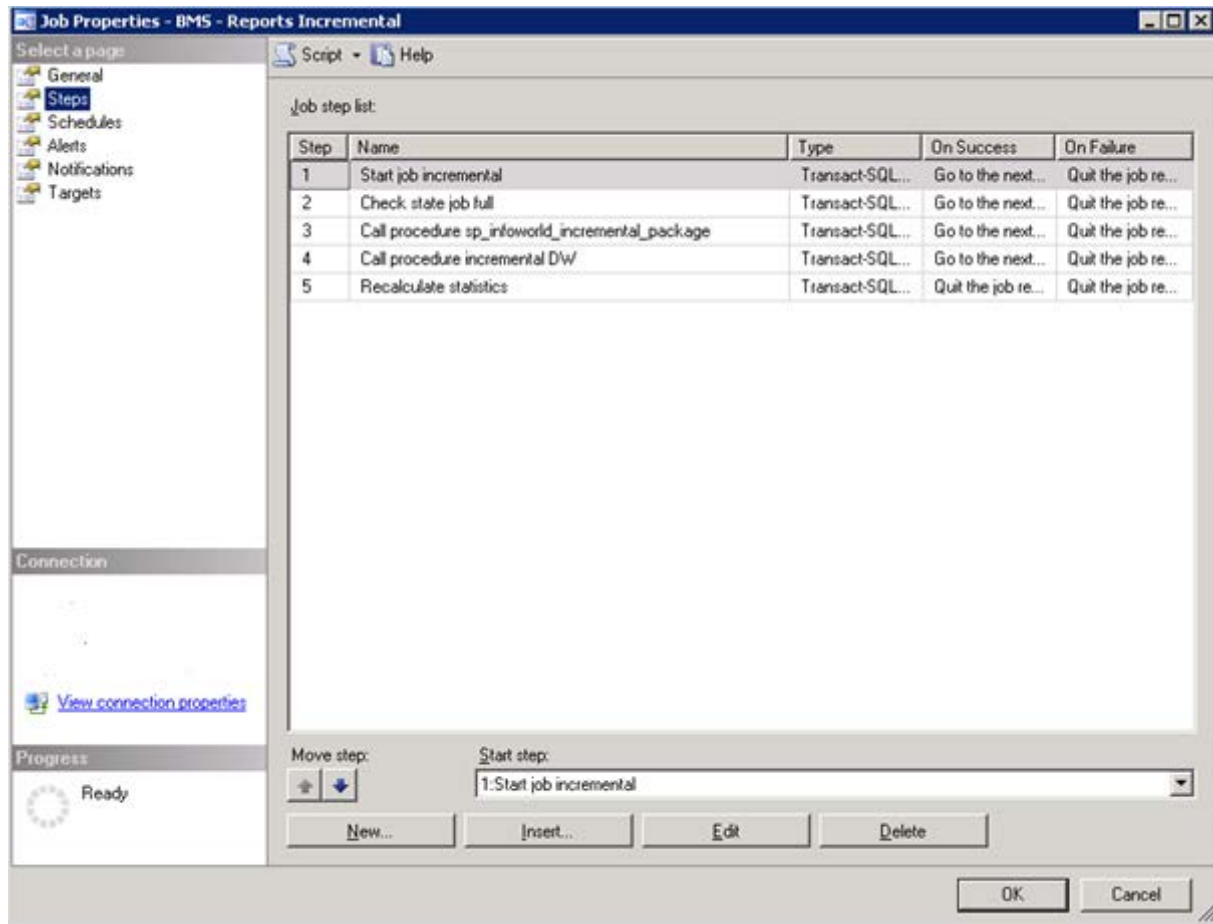

*Figure 11 - BMS - Report Incremental Job*

**Step 1.** Start job incremental: this is only an informative step for the log file.

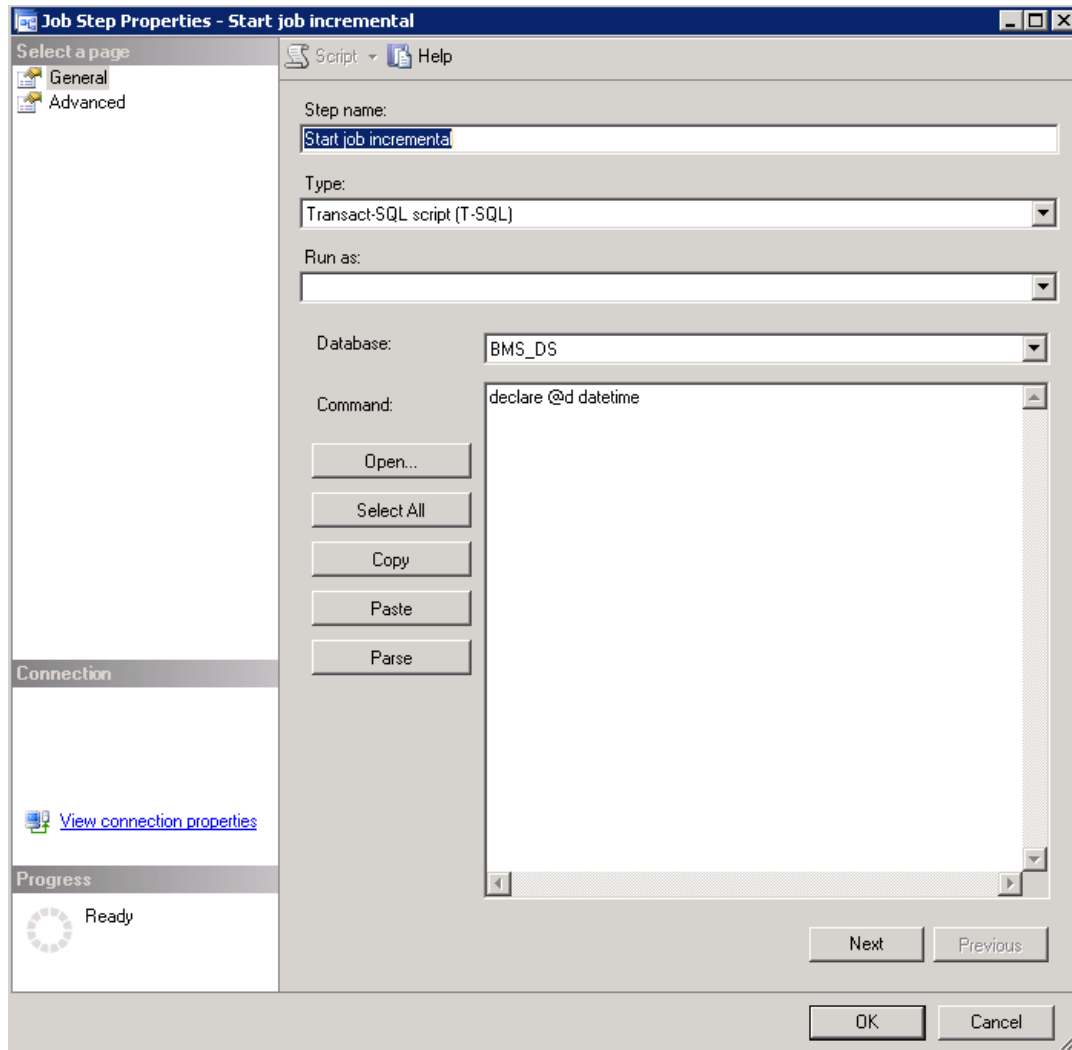

*Figure 12 - BMS - Start Job Incremental*

**Step 2.** Check state job full: it checks the state of the BMS full job described above in order to be sure that it is not currently running, in which case the incremental job cannot continue.

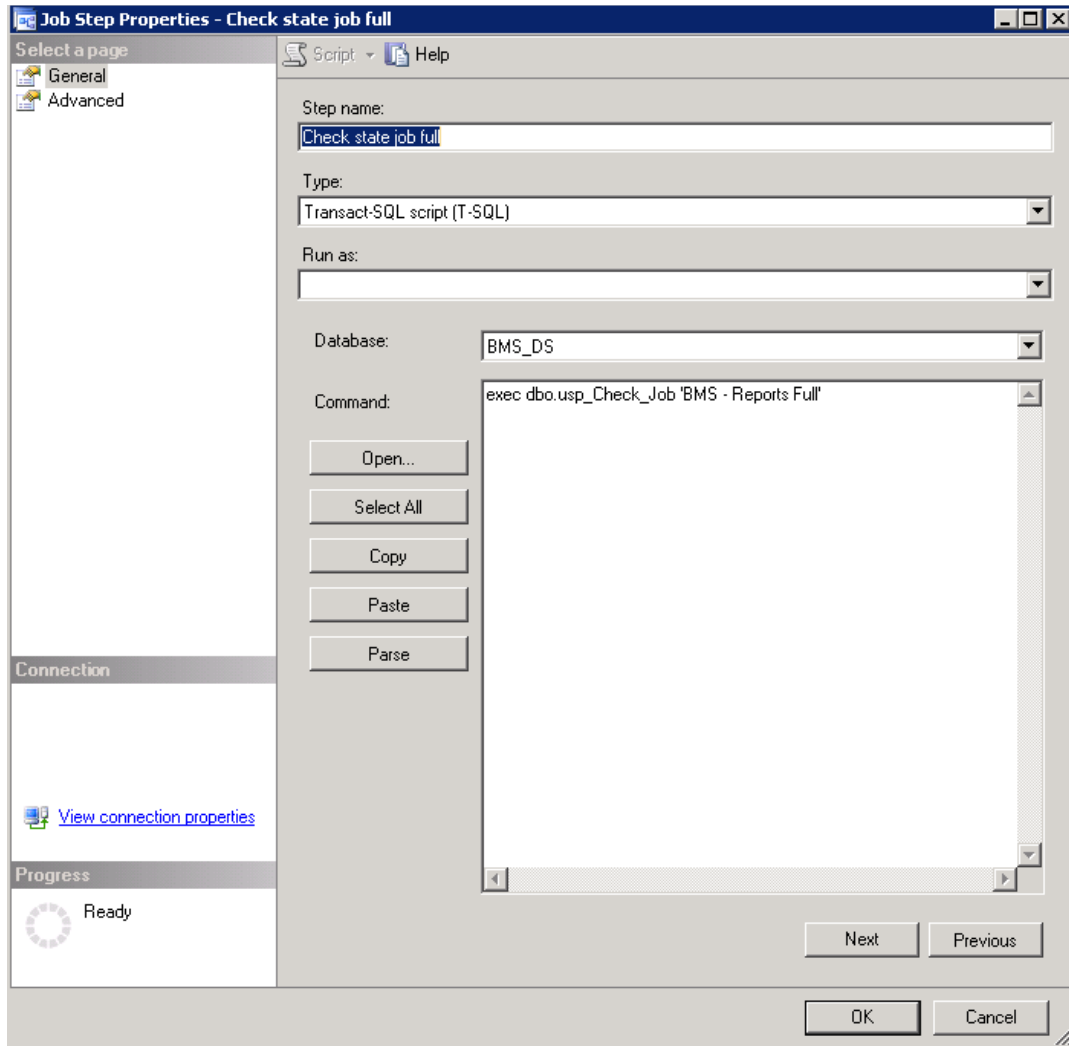

*Figure 13 - BMS - Check State Job Full*

**Step 3.** Call procedure `sp_infoworld_incremental_package`: makes all the necessary updates from the source databases to the BMS\_DS database. When rows are deleted in the source tables, an update is made in BMS\_DS database (in the necessary tables) by changing a flag column's value to 1 (deleted) from 0 (existing).

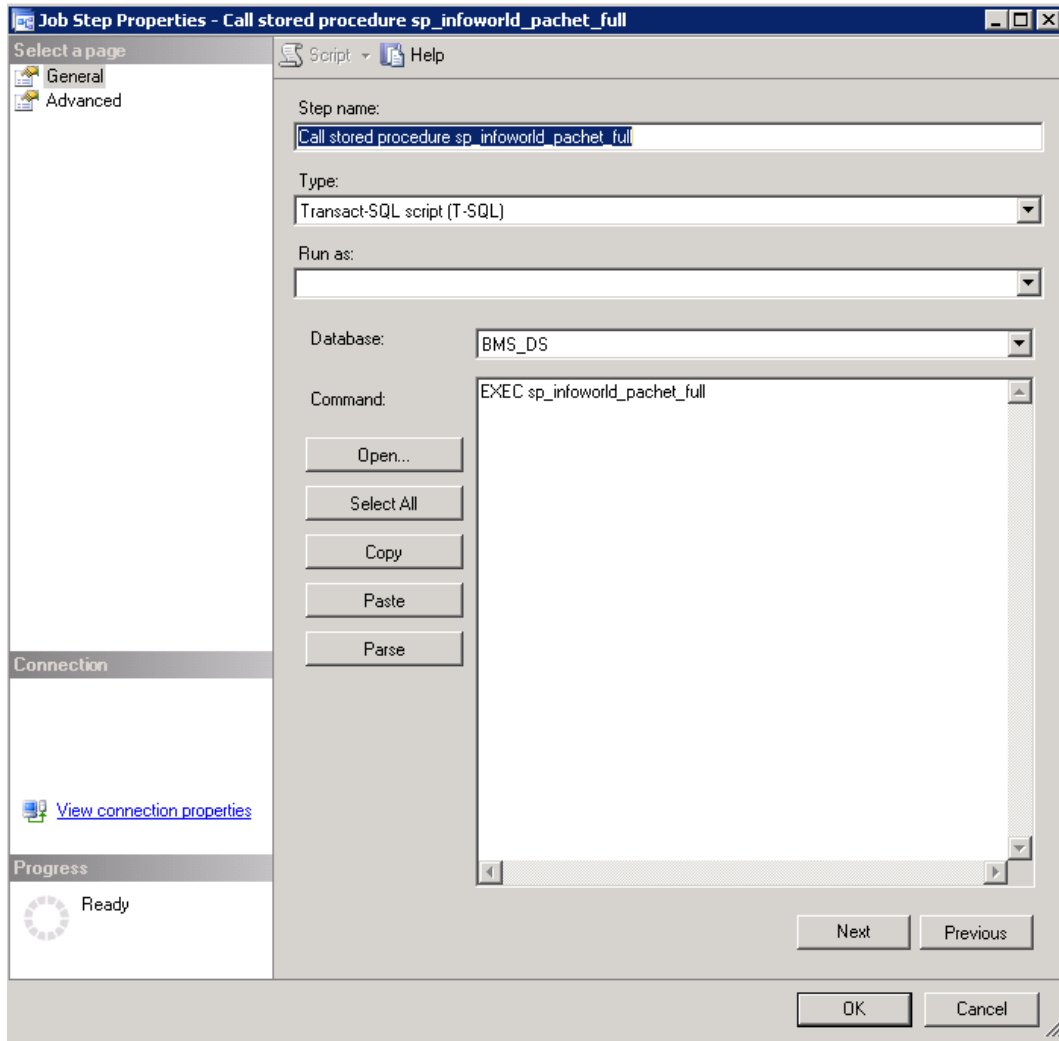

*Figure 14 - BMS - Call Procedure Properties*

**Step 4.** Call procedure incremental DW: will search for any new, updated or deleted row in BMS\_DS database's tables in order to do the correspondent operations in its tables.

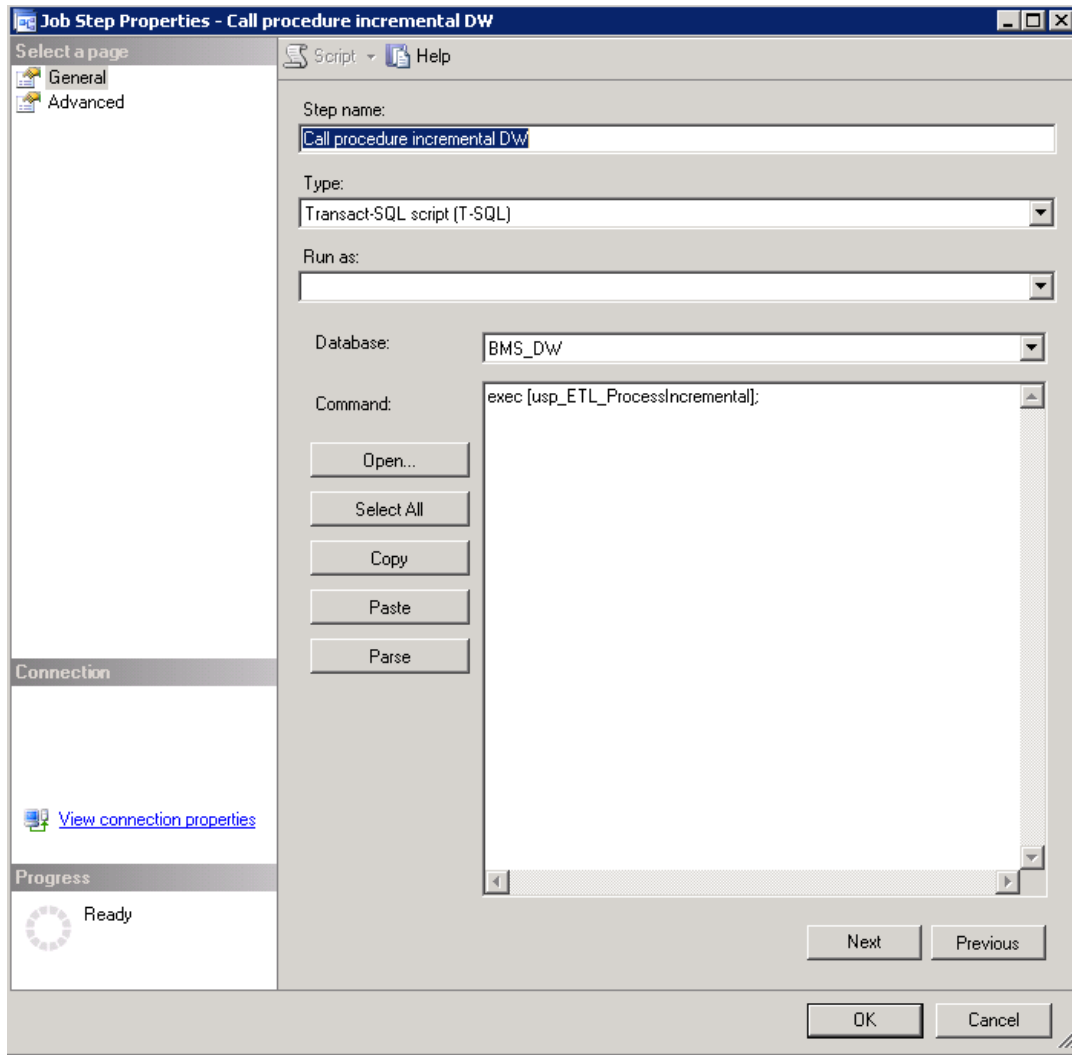

*Figure 15 - BMS - Call Procedure Incremental*

For each step a log file can be set, see screenshot below for step 4:

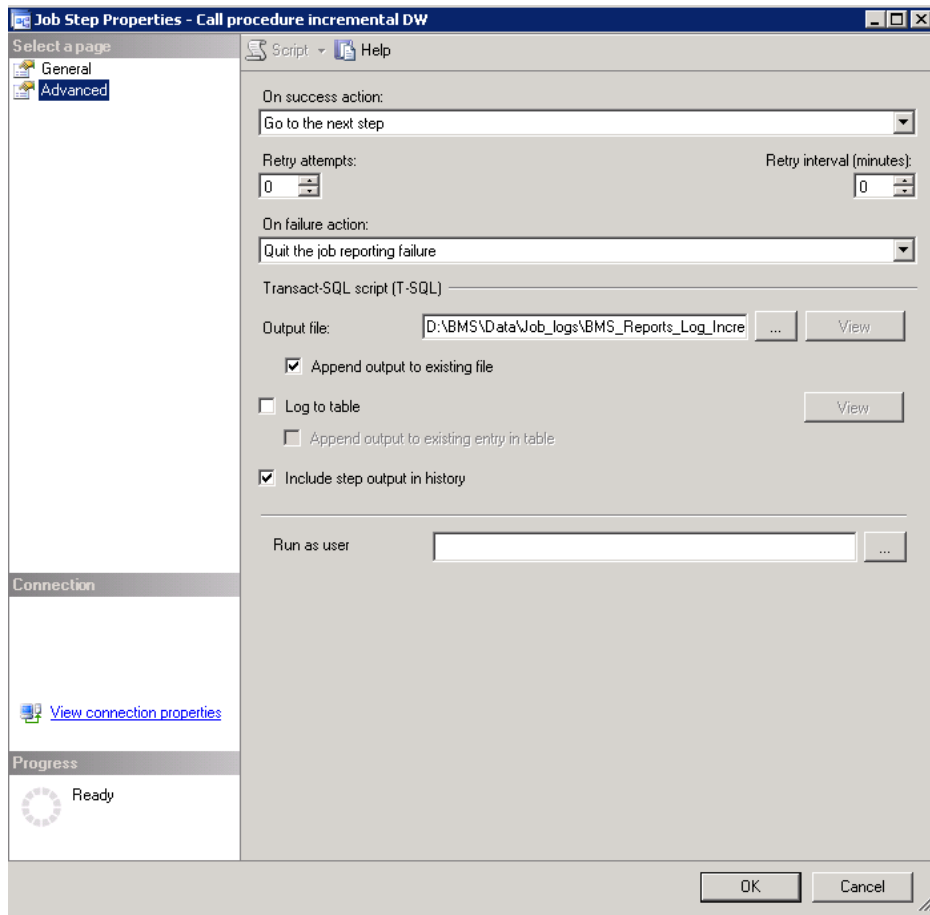

Figure 16 - BMS Incremental Path File Log

**Step 5.** If the duration of the last completed incremental job exceeded 3 minutes, then recalculate statistics to improve query plan execution for the next job run.

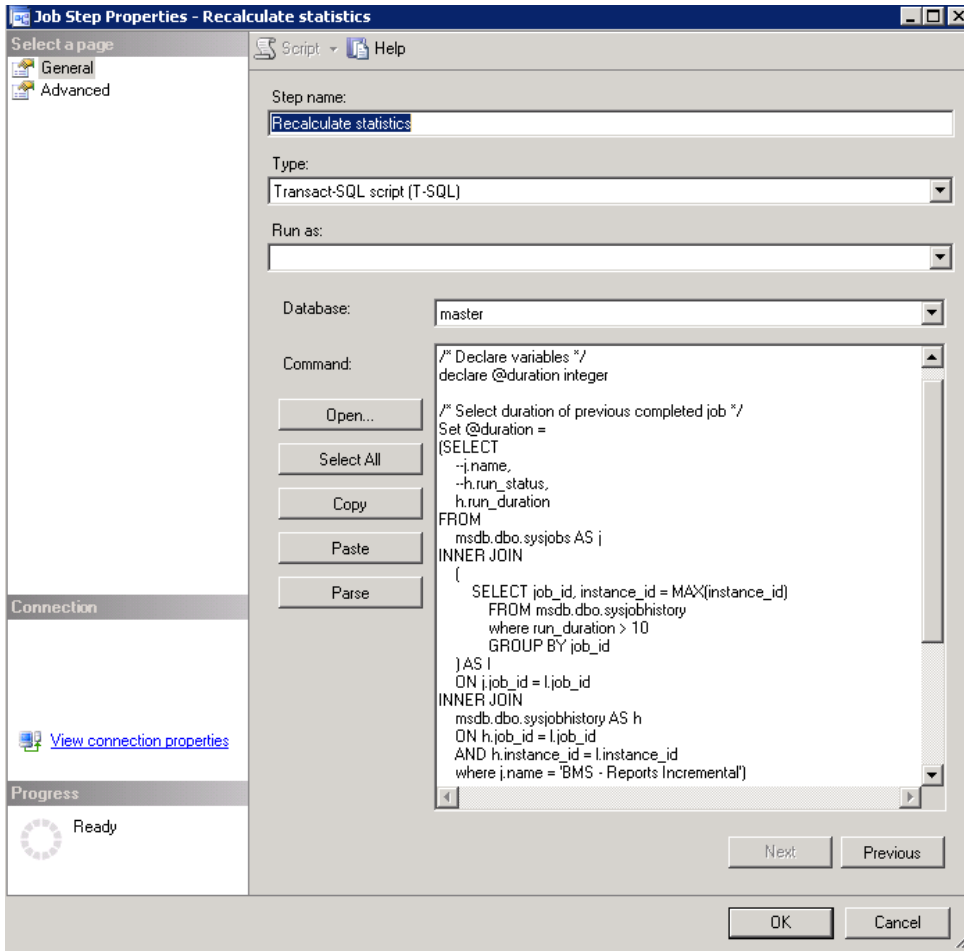

Figure 12 - BMS – Call procedure Recalculate Statistics

### 2.4.3 BMS Reports Windows Management Instrumentation (WMI)

This job runs a process through Windows Task Scheduler “BMS - Execute WMI\_UserGroup” that takes all the users and user groups from the Active Directory and inserts them in BMS\_DW database.

In order to run the process successfully, the user needs to configure WMI\_UserGroup.config file (Reference Table 12 - WMI User Group Configuration Parameters) and set the connection of the database in the Connections.xml file. These files are stored in the folder where WMI\_UserGroup application is installed.

The steps performed by this process include the following:

Below are the steps:

1. Deletes from the following tables from the BMS\_DW database:  
 dbo.DOMAIN\_USER\_GROUP  
 dbo.DIM\_DOMAIN\_USER  
 dbo.DIM\_DOMAIN\_GROUP
2. Inserts the domain groups (all) into dbo.DIM\_DOMAIN\_GROUP table
3. Inserts the users (all) into the dbo.DIM\_DOMAIN\_USER table
4. Inserts the users group information into the dbo.DOMAIN\_USER\_GROUP table.
  - a. Here it determines who belongs to what group and adds them, since a single user can belong to



- many groups
- 5. Writes the log messages
- 6. Closes the connections
- 7. Exits

Windows Task Scheduler calls a Batch script D:\BMS\Data\WMI\_UserGroup\WMI\_Wrapper.BAT. The script sets up some variables for Log Files. The 'Start' time is recorded in a variable then calls the WMI\_UserGroup binary file. After the execution of the binary file the 'End' time is recorded. Calculations for the duration are done between the 'Start' and 'End' times, the metrics is sent to Introscope via a batch script which calls a Powershell script to send the Data. If the 'Duration' was less than 8 minutes, the base wrapper script is called again with an additional parameter of "2" added ( Second run ).

Introscope records the 'Duration' and 'Exit' Results of the binary executable. If the second run also fails to complete with a duration longer than 8 minutes, email alerts are sent via the Introscope rules engine.

## 2.5 Ward Whiteboard Kiosk Mode Display Configuration (BMS Whiteboard Kiosk Setup)

An electronic kiosk (or computer kiosk) houses a computer terminal designed to function while preventing users from accessing system functions. BMS has adopted the use of electronic kiosks to provide sites with the capability to setup Large Screen Displays for the BMS Ward Whiteboard for greater visibility. The Whiteboard Kiosk is read only access page that presents an overview of the beds in the current facility (or in the selected ward) and allows the user to assess at a glance the bed availability in their facility (or ward). Kiosk mode locks down the user interface to protect applications from accidental or deliberate misuse. These displays should be placed carefully, considering that confidential patient data (Social Security Number) should not be in view of people who are not authorized to see it.

BED	PT	STAFF	ATTENDING	COMMENTS	DISCH STATUS	BED STATUS	WARD	HUPJ	LOS WARD
CR400-1T									
CR400-2T									
CR400-3T									
CR500-1T									
CR500-2T									
CR500-3T			SHALE, JOHN				T CR - GENERAL CWT/TR	🟡	17:04
CR700-1T									
CR700-2T			HINZE, KARLA				T CR - GENERAL CWT/TR	🟡	33:04
CR700-3T			SHALE, JOHN				T CR - GENERAL CWT/TR	🟡	21:04

Figure 2 - BMS Ward Whiteboard Screen

Setting up for the BMS Whiteboard Kiosk involves a series of steps that most often are performed by IT staff with access to Local Site network configuration and/or staff with authority to request the required Local Site and Active Directory (AD) network configuration changes.

Steps for configuring the BMS Whiteboard Kiosk can be divided into three major categories:

- The Ward Whiteboard Kiosk URL
- The Network User for BMS Kiosk Access
- The Kiosk Workstation for Local Site Use

Each category involves a series of required steps to ensure successful operation of the Kiosk. Following is an outline of the process to setup and configure the BMS Whiteboard Kiosk for a local site.

- 1) Create the Ward Whiteboard Kiosk URL. See details in [2.5.1 Create the Ward Whiteboard Kiosk URL](#)
  - a) Determine the BMS Whiteboard Parameters For Kiosk Operation and Setup
  - b) Test the URL in a browser
- 2) Set up a default user for the kiosk. See details in [2.5.2 Set up a default user for the BMS Kiosk](#)
  - a) Set up the Network User for BMS Access
  - b) Configure the Whiteboard Kiosk Default Login User in BMS
  - c) Assign a Role to the Whiteboard Kiosk Default User in BMS
- 3) Set up the Workstation / Kiosk Machine. See details in [2.5.3 Set up the Workstation / Kiosk Machine](#)
  - a) Disable the Screen Saver
  - b) Configure the Power Settings to Disable Sleep and Stand By Mode
  - c) Configure Auto Log in Option and stop MS Lync from opening upon start up
  - d) Set the URL as the Home Page in IE
  - e) Add <https://vawww.bms.va.gov> to “Trusted Sites” in IE
  - f) Add to the start-up commands (Windows) the launch of the browser
  - g) Close IE, and restart to test
  - h) Set Registry Keys to configure Kiosk for local Site use

## 2.5.1 Create the Ward Whiteboard Kiosk URL

The Ward Whiteboard display uses parameters to determine the behavior of the display. For example, the whiteboard can display a specific ward or ALL wards for a site by setting the parameter **wardName**. Below is a description for each whiteboard display parameter along with available options for each.

Parameter	Short Description	Options
facilityCode	Code of facility (e.g., BROCKTON = BRK).	Enter the 3 character facility ID.
wardName	Name of BMS Ward Name. To see all the wards the value that needs to be configured is ALL.	These are the BMS WARDS as defined in the Facility, Site Options, VistA Ward Add/Edit. The Ward name value should match the "BMS WARD GROUP TEXT". A single ward can be entered or the value "ALL" to display all the wards at the facility.
splitScreen	To split the page in two tables enters the value "Yes".	Yes No
displayPTCode	How the patient should be displayed under the column "Patient" (full name or 1st+Last 4) or LastName. <b>LastName is required for Kiosk mode due to Privacy regulations.</b>	FirstAndLast4 <b>LastName</b>
genderColorCode	To change the background color for the row according with patient's gender.	Blue/Pink None
displayFooterCensus	To view the footer census.	Yes No
displayStaffAttending	What column is displayed in the table? (Staff column, Attending column or both).	Staff and Attending Staff Attending
scrollRate	The timer interval will affect the scrolling speed. This parameter can be absent. (If specified then it represents seconds).	Null or an integer value.

Table 15 - Ward Whiteboard URL Configuration Parameters

### 2.5.1.1 Determine the parameters for the Kiosk, and create the URL

Sample URL to display All Wards for site BRK:

<https://vaww.bms.va.gov/WardWhiteboardUrl?facilityCode=BRK&wardName=ALL&splitScreen=No&displayPTCode=LastName&genderColorCode=Blue/Pink&displayFooterCensus=Yes&displayStaffAttending=Staff%20and%20Attending&scrollRate=20>

### 2.5.1.2 Test the URL

Once you have the URL, type it into a browser to test. The BMS Ward Whiteboard should come up. Note: a site can have a different URL for each kiosk.

## 2.5.2 Set up a default user for the BMS Kiosk

Create a network service account for accessing the BMS page. Make sure that it is in an Organizational Unit (OU) that will not get the Enterprise System Engineering (ESE) Federal Desktop Core Configuration (FDCC) / US Government Configuration Baseline (USGCB) User Settings. Set the “Log on to” so the account can only log onto the kiosk PC you are setting up.

### 2.5.2.1 Set up the Network User for BMS Access

- Create AD User with non-expiring password under Service Accounts for the local site. If you are not an AD administrator then provide the following instruction to the AD along with your request for a new service account.

In Active Directory Create a Generic User with a Non-Expiring password in Service Accounts for your location with Access to All Computers.

**NOTE: You will create a single ID, not one for every PC. Also, do not setup auto login with this generic account at this point as PCs will automatically lock at this level.**

- Right click the “Service Accounts” folder (VXX.med.va.gov/VISNxx/Facility(XXX)/Service Accounts) and select New...User.  
**NOTE: Do not use the “Service Accounts” folder directly under vXX.med.va.gov.** Under First Name, enter vhaXXX\_\_\_\_\_ (such as vhaSTLBMSUser)
- Enter the same under “User Login Name”
- Enter a password when prompted and select
- Uncheck “User must change password at next logon”
- Check “Password never expires”
- Click “OK” at the warning that the user will not be prompted to change the password.
- Click “Next”
- At the top of the screen the path should read, “vXX.med.va.gov/VISNxx/Facility(XXX)/Service Accounts”
- Uncheck “Create an Exchange Mailbox”
- Click “Next”
- Review confirmation screen for accuracy and click “Finish”.
- Your new account should be available in your “Service Accounts” list. You may have to refresh your list to see it.
- Double-click your new account, in the description field, add
- SERVICE ACCOUNT: VHAxxxxxxx(YourUserName): BMS DISPLAY
- In the Account tab, ensure “This user can log on to “All computers”. Do not identify any specific computers.
- When you are finished, your new account in the Service Accounts list should only show a Name, Type, and Description. All other fields should be blank.

### 2.5.2.2 Configure the Whiteboard Kiosk Default Login User in BMS

For the current facility that will display the associated Whiteboard page, a default user needs to be configured in BMS application for the Ward Whiteboard Kiosk.

To configure the Whiteboard Kiosk Default User:

- **Go to the BMS Site Home Page**

- **Click on the Site Options link**
- **Click on the Facility Setting link**
- **Fill the fields “Whiteboard Kiosk Default User Name:”, “Whiteboard Kiosk Password:” and “Whiteboard Kiosk Password Confirm:” with the BMS Service Account ID**

PARAMETER	OPTIONS
BMS Server Time Zone	CENTRAL STANDARD TIME
Facility Site Time Zone	CST
Auto-Removal Patients Pending Bed Placement List?	Yes
Integrated Facility?	No
Facility Name:	VA NORTH TEXAS HEALTH CARE SYSTEM: DALLAS VA
Facility Address 1:	4500 S. LANCASTER RD.
Facility Address 2:	DALLAS, TEXAS 75216
Facility Point-of-Contact:	JEFFREY D ALLEN
Facility POC Email:	JEFFREYD.ALLEN@VA.GOV
Facility POC Telephone:	214 857 4607
Local Time Adjust:	0
EMS Default User Name:	vhantbedmgmt
EMS Password:	
EMS Password Confirm:	
Whiteboard Kiosk Default User Name:	vhantbedmgmt
Whiteboard Kiosk Password:	
Whiteboard Kiosk Password Confirm:	

Figure 3 - Facility Settings

- **Click Submit**

### 2.5.2.3 Assign a Role to the Whiteboard Kiosk Default User in BMS

Each facility must assign the BMS “EMS USER” Role to the Service Account ID created to run the Whiteboard Kiosk URL. This assignment can be done from the **BMS Admin Section → Add/Edit BMS User** hyperlink or Facility **Site Options → BMS User Add/Edit** hyperlink.

- *Click the **Select Existing NT User Name** button*
- *Select the correct VISN Domain from the left Drop Down Box.*
- *In the User Name box Enter the BMS Service Account ID created for the BMS EMS/Whiteboard Kiosk. Then click the **Find** button*
- *Click the Selected Radio button for the user. Then click the **Select** button.*
- *In the EMS User box, select “Yes”. All other roles should be “No”.*
- *In the Default Region box, select the correct Region.*
- *In the Default VISN box, select the correct VISN.*
- *In the Default Site box, select your Site.*
- *In the READ Access box, select “Yes”.*
- *In the WRITE Access box, select “Yes”.*

Figure 4 - Whiteboard Kiosk User Role Assignment Fields Filled in on the BMS Admin Section Add/Edit BMS User Page

- *Click Submit*

## 2.5.3 Set up the Workstation / Kiosk Machine

After setting up the workstation / Kiosk machine, it will automatically log in to Windows, and automatically login to BMS.

### 2.5.3.1 Disable Screen Saver

In order to display the Whiteboard page continuously the screen saver needs to be disabled.

NOTE: The Windows menu that allows the disable of the screen saver might be different from one version of Windows to another. For example, for Windows 7 the needed operations are:

- *Right click on the desktop*
- *Click Personalize*

- *Click on the screensaver button on the lower-right part of the page*

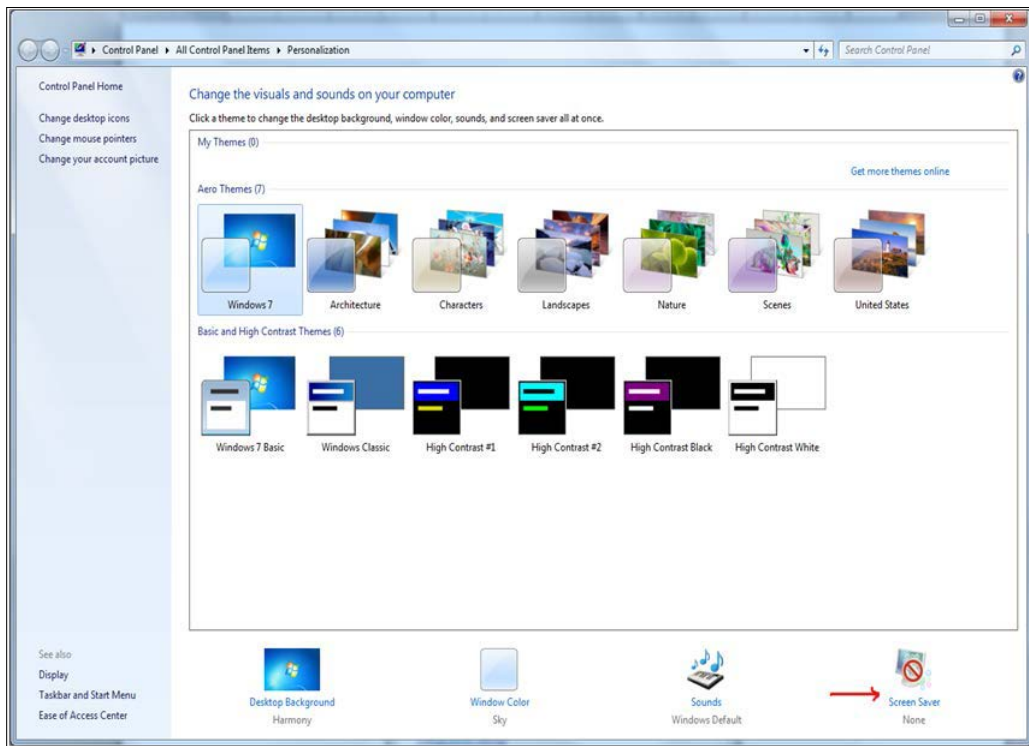

Figure 5 - Screen Saver Option

- *Select None from the screensaver drop down on the displayed form*

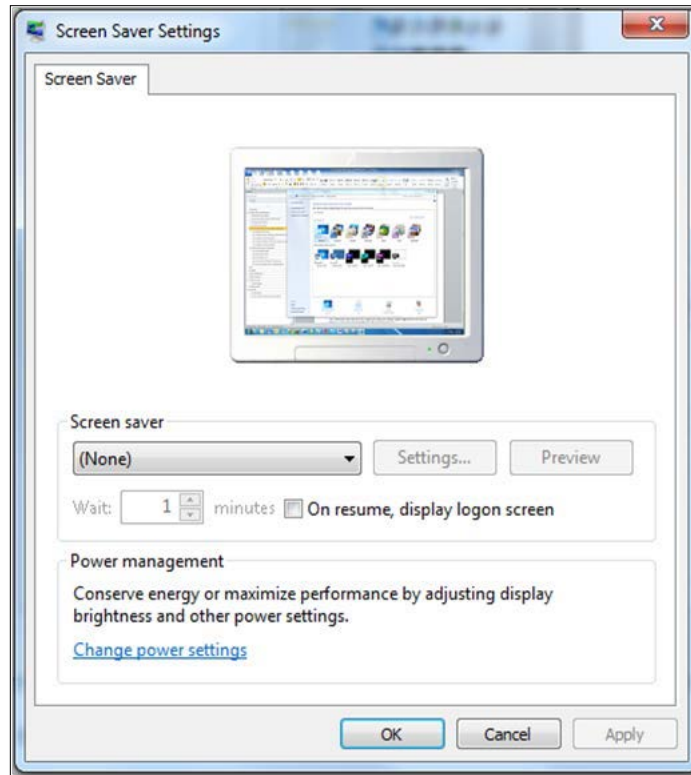

Figure 6 - Screen Saver Settings Window

- *Click OK.*

### **2.5.3.2 Configure Power Settings: Disable Sleep and Stand-by Mode**

In order to display the Whiteboard page continuously the power settings need to be adjusted so that the computer will never enter into hibernate or stand-by and also the screen will never turn off.

**NOTE:** The Windows menu that allows the configuration of the power settings might be different from one version of Windows to another. For example, for Windows 7 the needed operations are:

- *Go To Control Panel*
- *Select Power Options*



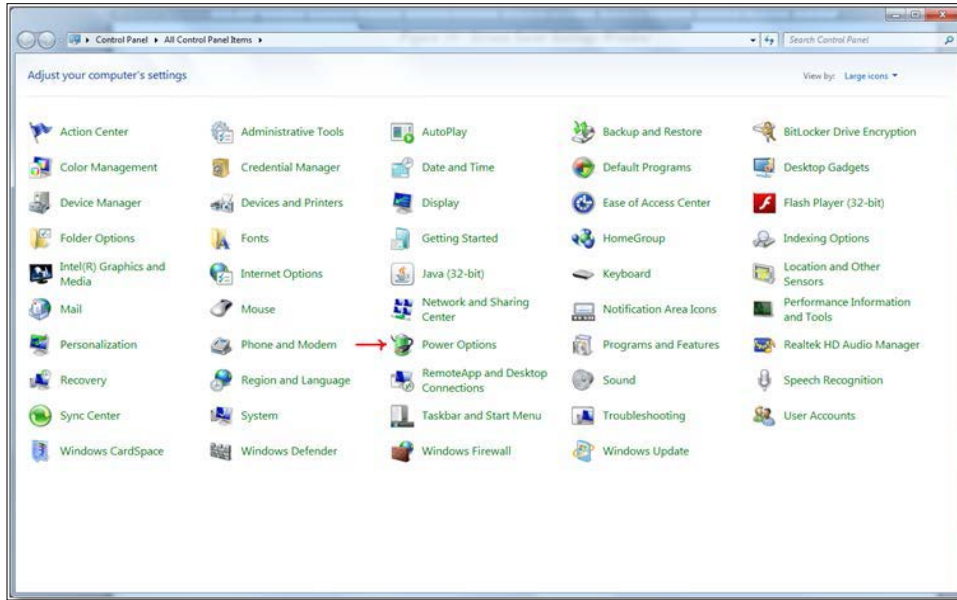

Figure 7 - Power Options

- *Click on “Change Plan settings” for the active plan*

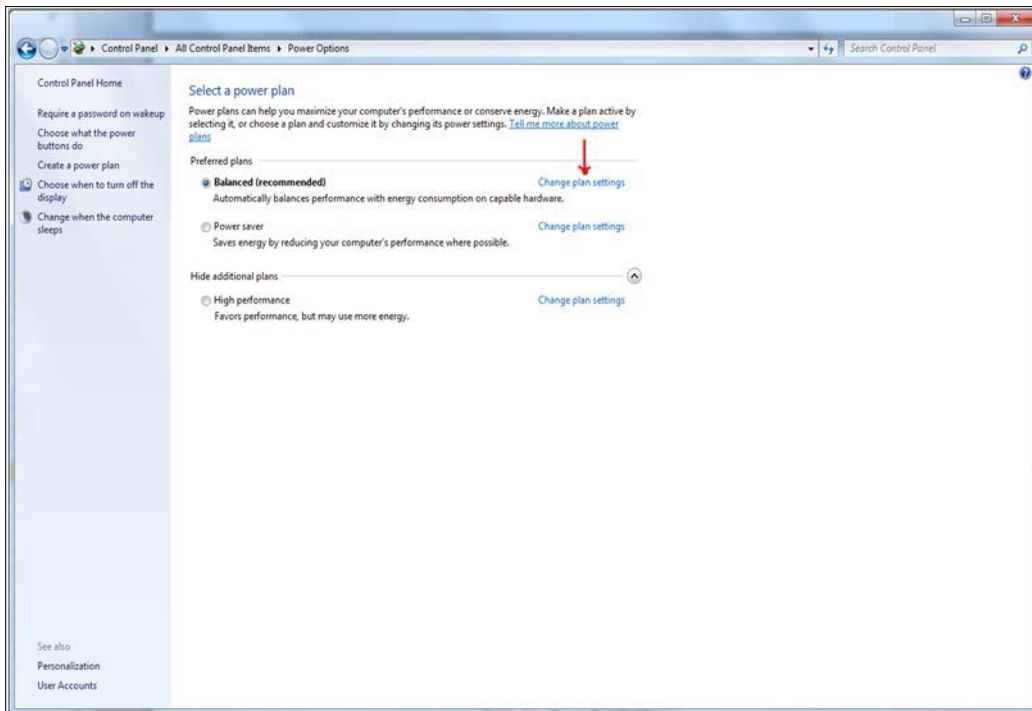

Figure 8 - Change Plan Settings Option

- *Select “Never” from the drop downs associated with “Turn off the display” and “Put the computer to sleep”*

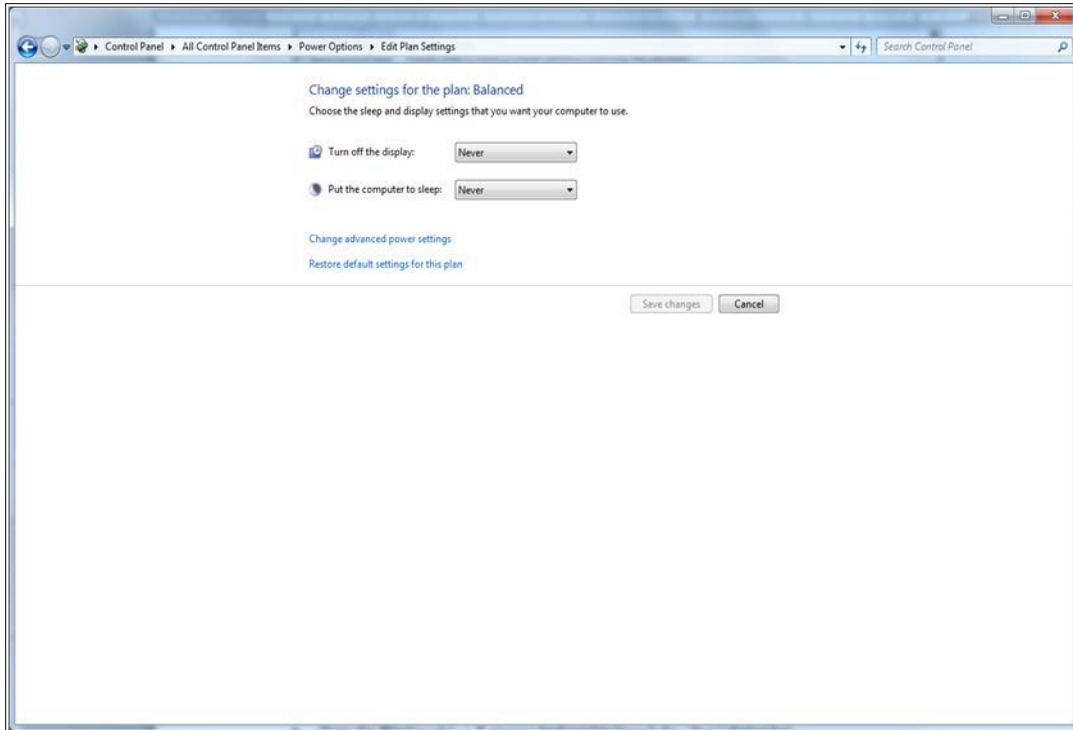

Figure 9 - Power Options Settings

- Click "Save changes"

### 2.5.3.3 Configure Auto-login Option and stop Microsoft Lync from opening upon start up

**Configure Auto-Login:** The computer that will display the Whiteboard page needs to have the auto-login configuration set to "true".

**NOTE:** The Windows menu that allows the configuration of the auto-login settings might be different from one version of Windows to another. For example, for Windows 7 the needed operations are:

- Press the Windows key + R on your keyboard to launch the "Run" dialog box.

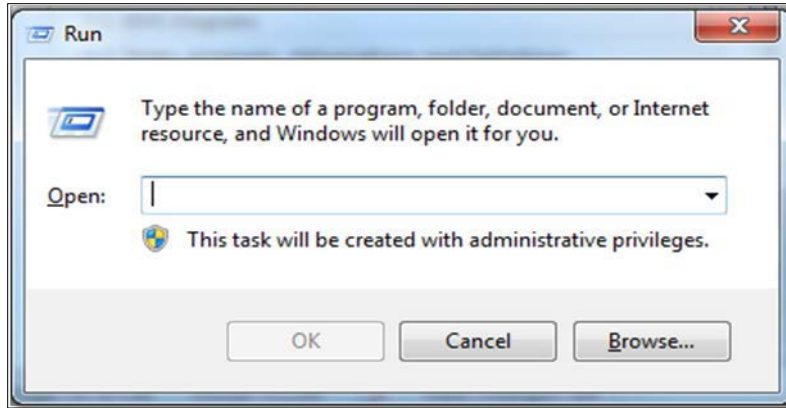

Figure 10 - Run Window

- *Type in “control userpasswords2”*

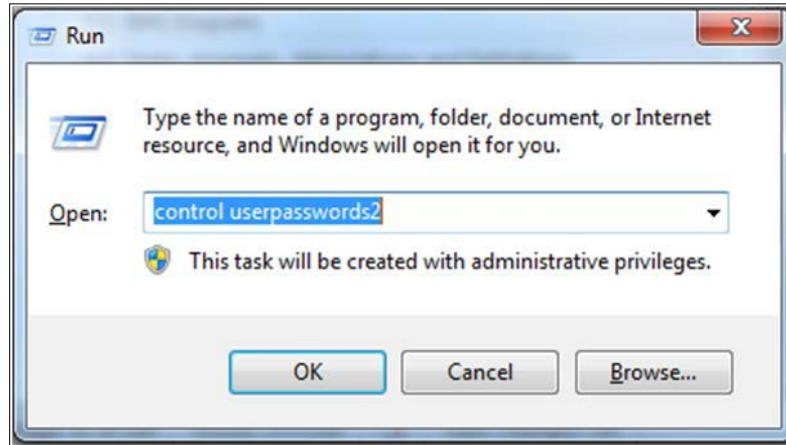

Figure 11 - Run Window with Command Entered

- *Press Enter. The User Accounts window will display.*

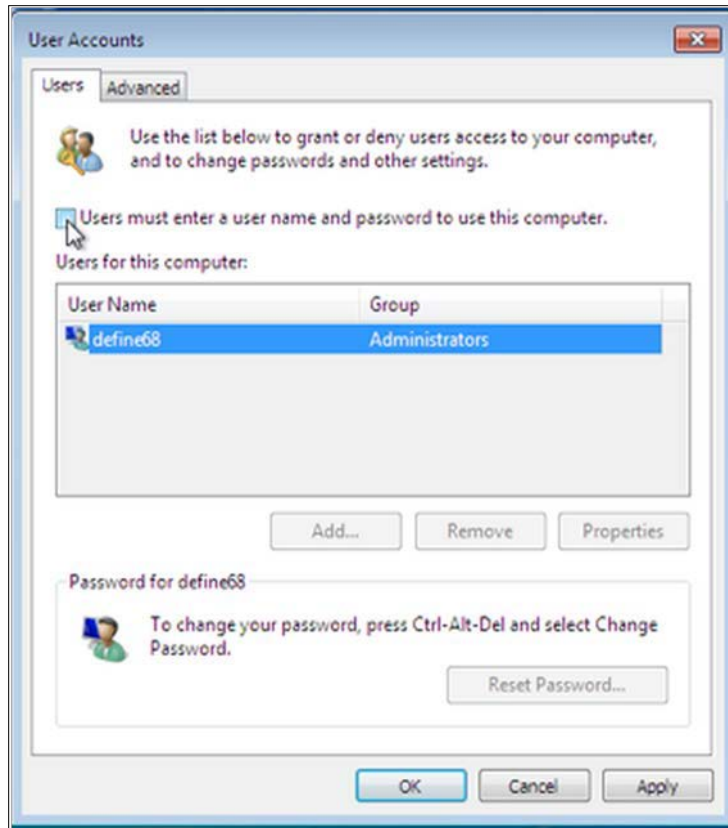

Figure 12 - User Accounts Window

- *Uncheck the option “Users must enter a user name and password to use this computer” for the BMS Default Kiosk User Account*



Figure 13 - User must enter a user name and password to use this computer option

- Click "OK"

Stop Microsoft Lync from opening at startup: **To stop Microsoft Lync from opening at startup follow the steps below**

- From the Start Menu,
- Go to All Programs > Microsoft Lync
- Open Microsoft Lync
- Go to Tools > Options > Personal
- Uncheck "automatically start Lync when I log on to Windows" & "Show Lync in foreground when it starts".

#### 2.5.3.4 Set the URL (from step 2.5.1) as the Home Page in Internet Explorer

The specific Ward Whiteboard Kiosk URL needs to be configured as the Home-Page for the intended browser. The menu to set the default home-page might differ from one browser to another.

For example, for Internet Explorer (IE) 9.0 the user needs to:

- Select Tools menu

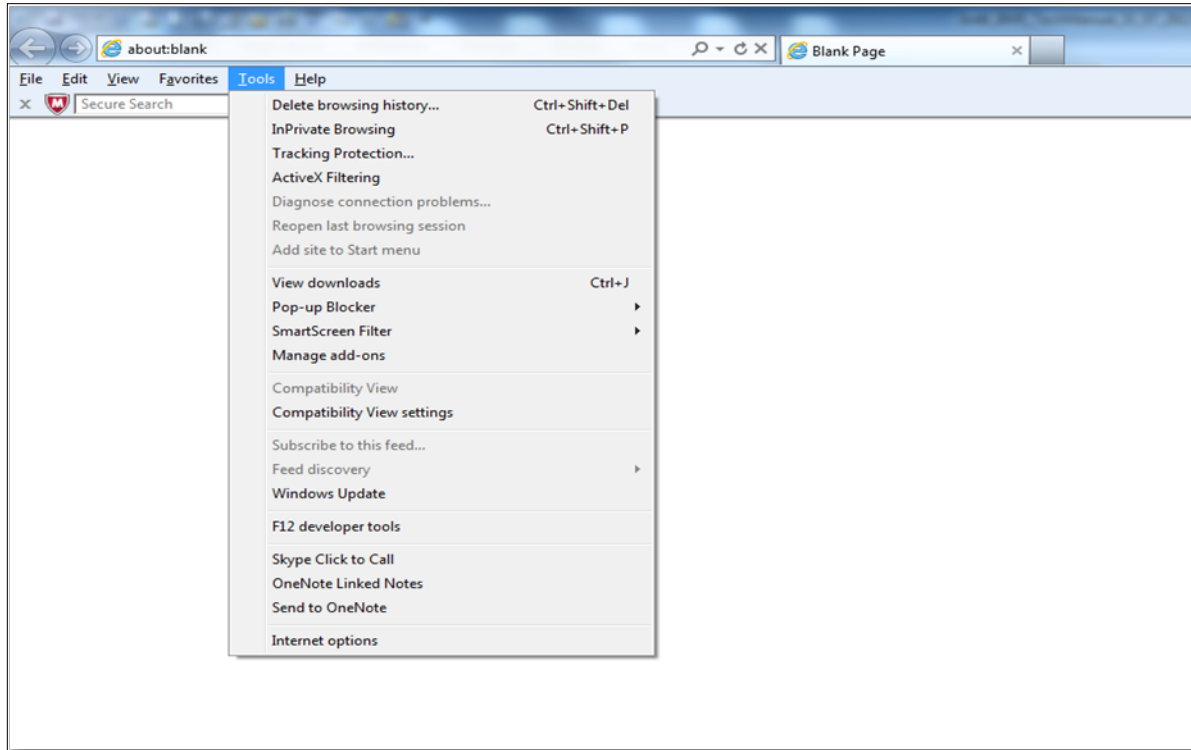

Figure 14 - Tools Menu of Internet Explorer

- *Select Internet Options*
- *On the General tab, under the homepage text field enter the URL*
- *Click OK*

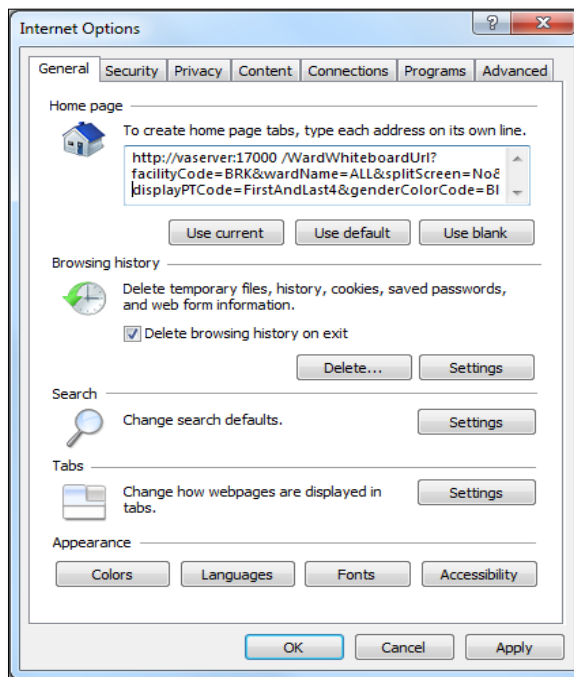

Figure 15 - General Tab of Internet Options

### 2.5.3.5 Add BMS to the “Trusted Sites”

To add BMS to “Trusted Sites” in Internet Explorer

- *Go to Tools>Internet Options>Security>Trusted sites>Sites*
- *In the “Add this website to the zone:” field, enter https://vawww.bms.va.gov*
- *Click Add, Click OK*

### 2.5.3.6 Add the launch of the browser to the Windows start up commands.

The next step is to add to the startup commands the launch of the chosen browser.

**NOTE:** This operation might differ from one version of Windows to another. For example for Windows 7 the steps needed are:

- *Click Start*
- *Select All Programs*
- *Right click on the Startup folder*
- *Select Open*

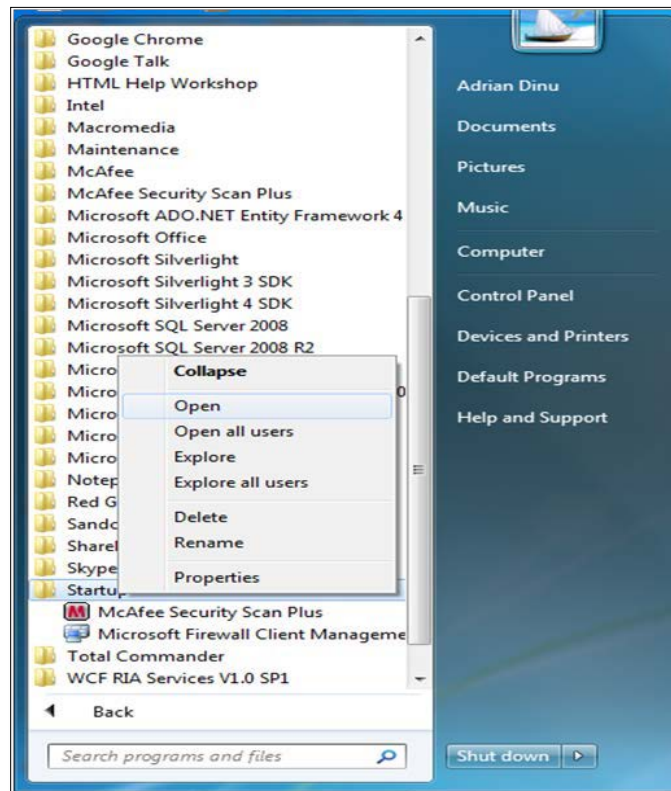

Figure 16 - Open Option

- Create a shortcut of the Internet Explorer and copy it to Startup folder

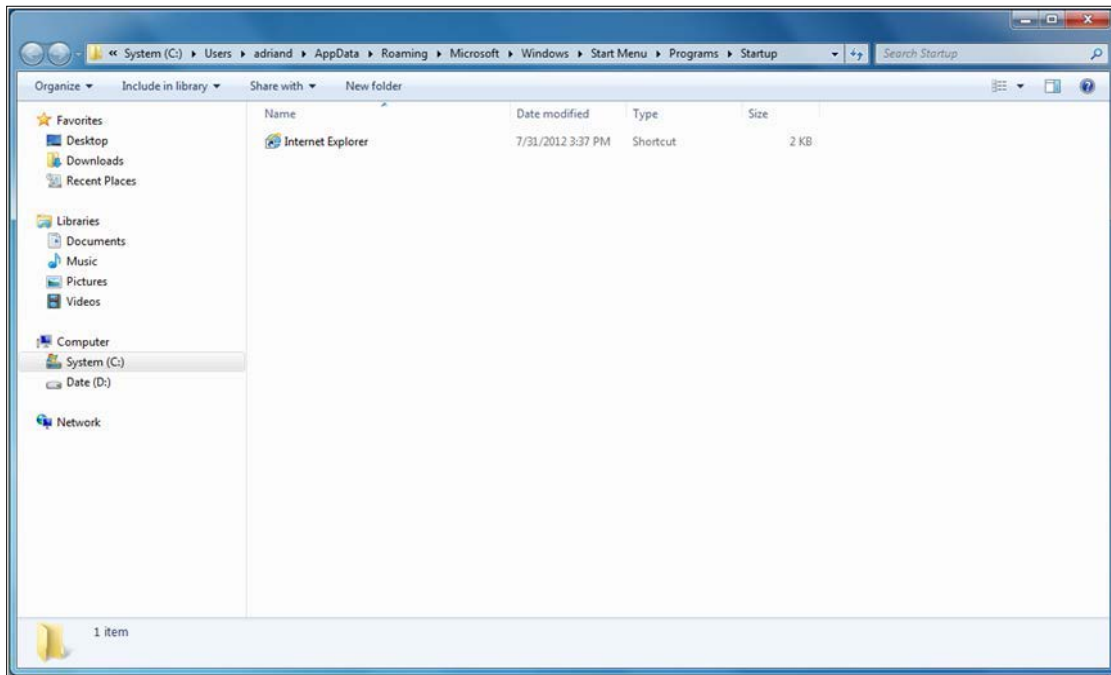

Figure 17 - Internet Explorer Shortcut

### 2.5.3.7 Test the Kiosk

Close Internet Explorer. Restart Internet Explorer. The BMS Ward Whiteboard for the Kiosk should come up.

### 2.5.3.8 Set the Registry Keys to configure the Kiosk for local site use.

The purpose of the following steps is to configure Kiosk workstation to serve one function only: BMS Ward Whiteboard display. The following instruction leads you through a series of steps that effectively lock down the workstation for this purpose. Access to workstation software and/or desktop will be prevented after the configuration setup is complete. The Whiteboard Kiosk is read only.

\*It is recommended that prior to performing the configuration steps outlined in this section a backup of the existing system be created for rollback / recovery purposes, and that a restoration point be created.

- 1) Modify Registry Settings

#### Restriction.reg

```
Windows Registry Editor Version 5.00

[HKEY_LOCAL_MACHINE\SOFTWARE\Policies\Microsoft\Internet Explorer\Restrictions]
"NoBrowserContextMenu"=dword:00000001
"NoFileOpen"=dword:00000001
"NoOpenInNewWnd"=dword:00000001
```



Figure 18 - Windows Registry Editor

Run Restrictions.reg by double-clicking filename from Windows Explorer.  
Verify settings have been applied.

2) Modify Local Group Policy Settings

For local group policy changes run gpedit.msc and make the following changes:

User Configuration\Administrative Templates\System\Ctr+Alt+Del Options  
Remove TaskManager..... Disable  
Remove Lock Computer..... Enable  
Remove Change Password..... Enable  
Remove Logoff..... Enable

User Configuration\Administrative Templates\Control Panel\Display  
o Password protect the screen saver..... Disabled

Verify all settings have been applied. The purpose of these settings is to lock down the workstation for one purpose only, BMS Whiteboard Kiosk.

3) Reboot Kiosk Machine to test set up.

\*Note; if Kiosk continually “freezes”, please contact the Service Desk to have an IE Refresher script installed.

## 2.6 Whiteboard Snapshot Configuration

In order to configure the Whiteboard snapshot certain steps need to be completed:

1. Create snapshot folder
2. Define network share
3. Assign rights to user
4. Assign snapshot folder path to ward group
5. Associate scheduler with the whiteboard report

Suppose the goal is to configure the settings for two BMS Ward Groups: WARD GROUP 1 and WARD GROUP 2.

Assuming that these two Ward groups are in different physical locations, a designated workstation will be assigned for each one of them.

For the purpose of example, these workstations are called: WARDGROUP1-PC and WARDGROUP2-PC.

### 2.6.1 Create Snapshot Folder

On WARDGROUP1-PC and WARDGROUP2-PC, a folder should be created for this purpose. For example, assume that this folder is on the “C:” drive, like this “C:\WhiteboardSnapshot”.

*On Windows 7 the needed operations are:*

- Click Start button
- Select All Programs

- Select Accessories folder
- Click Windows Explorer
- Go to C drive
- Right click on C drive
- Select New folder
- Enter the name of the folder, e.g. WhiteboardSnapshot

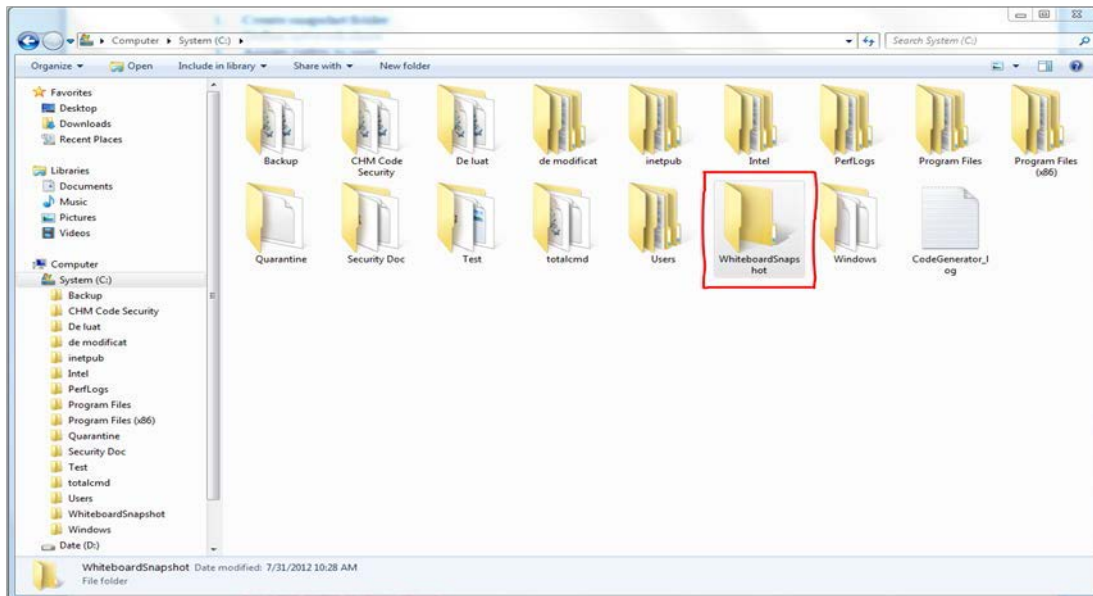

Figure 19: Whiteboard Snapshot Folder

## 2.6.2 Define Network Share

For these two folders (one on each computer) the Network Admin needs to define network shares. For example, assume that the network share name on each computer is “WhiteboardSnapshot”.

*Note: The Windows menu that allows the configuration of folder sharing might be different from one version of Windows to another. For example, for Windows 7 the needed operations are:*

- *Navigate to the “WhiteboardSnapshot” folder, right-click it and choose Properties*

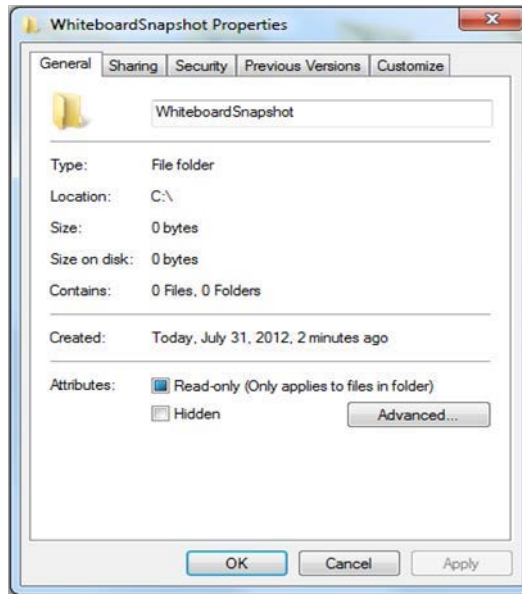

Figure 20: Whiteboard Snapshot Folder Properties

- *Go to Sharing tab and select Advance Sharing option.*

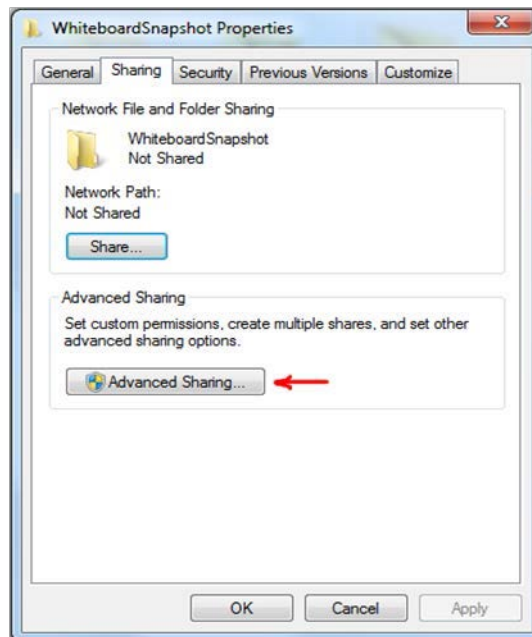

Figure 21: Advanced Sharing Option

- *In Advanced Sharing dialog, enable Share this folder option. It will automatically add folder's name as Share name.*

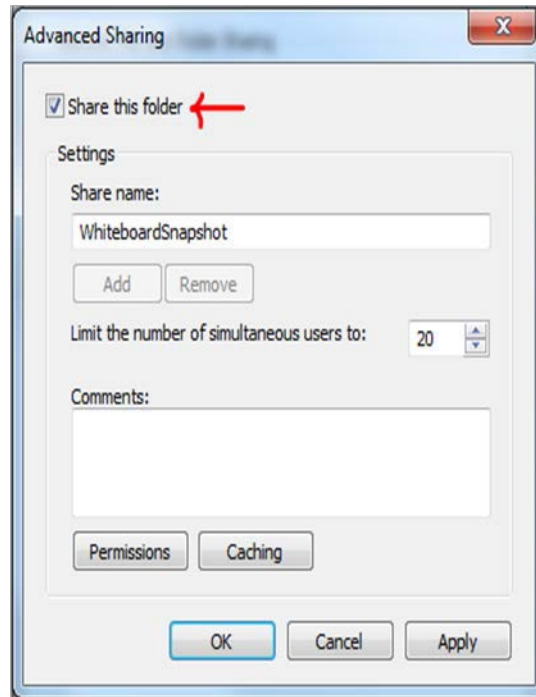

Figure 22: Share this folder Option

### 2.6.3 Assign Rights to Master BMS Service Account User

The BMS Application runs under a service account. AICT has created the Windows User (**acc\bms\_svc\_prod**) as the master service account that the BMS Services runs under. The Windows user (**aac\bms\_svc\_prod**) that is configured to be the Login that runs the four BMS Windows Services needs to have full rights to these shares.

This user must have full control on each facilities file folder that is used to store the Whiteboard Contingency Reports.

*On Windows 7 the needed operations are:*

- *Having Advanced Sharing window open click on Permissions button to set the folder's permissions.*

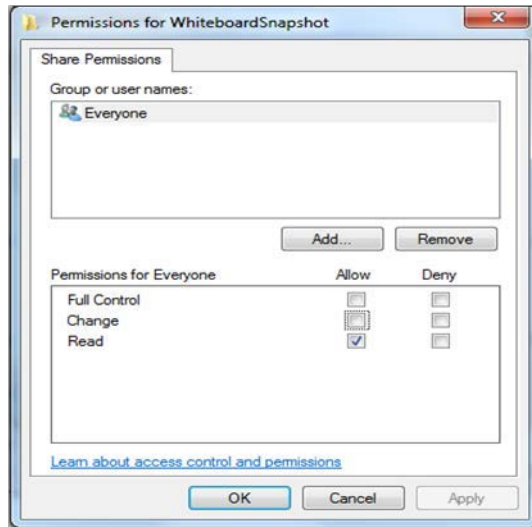

Figure 23: Permissions for Whiteboard Snapshot

- *In the Permissions window click Add button to set the network user rights on the shared folder.*

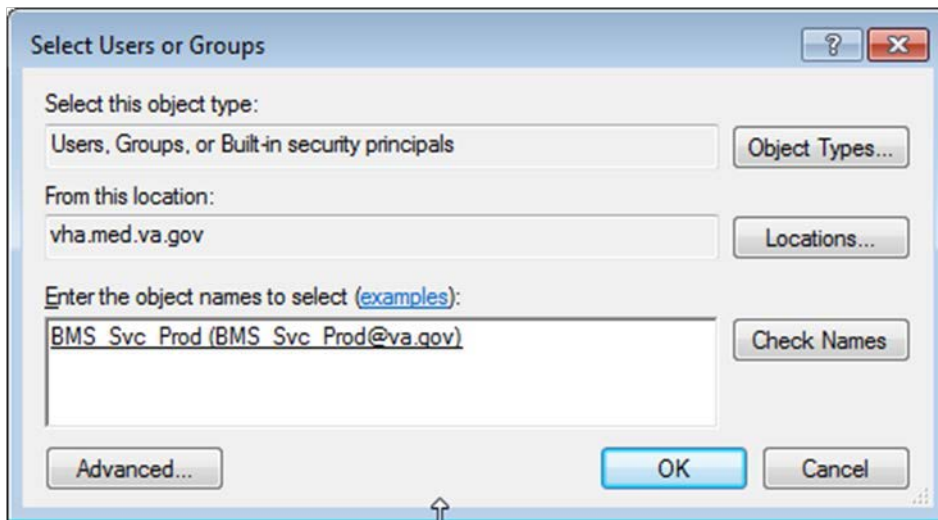

Figure 24: Select Users or Groups Window

- *Click “Advanced” button to select user.*

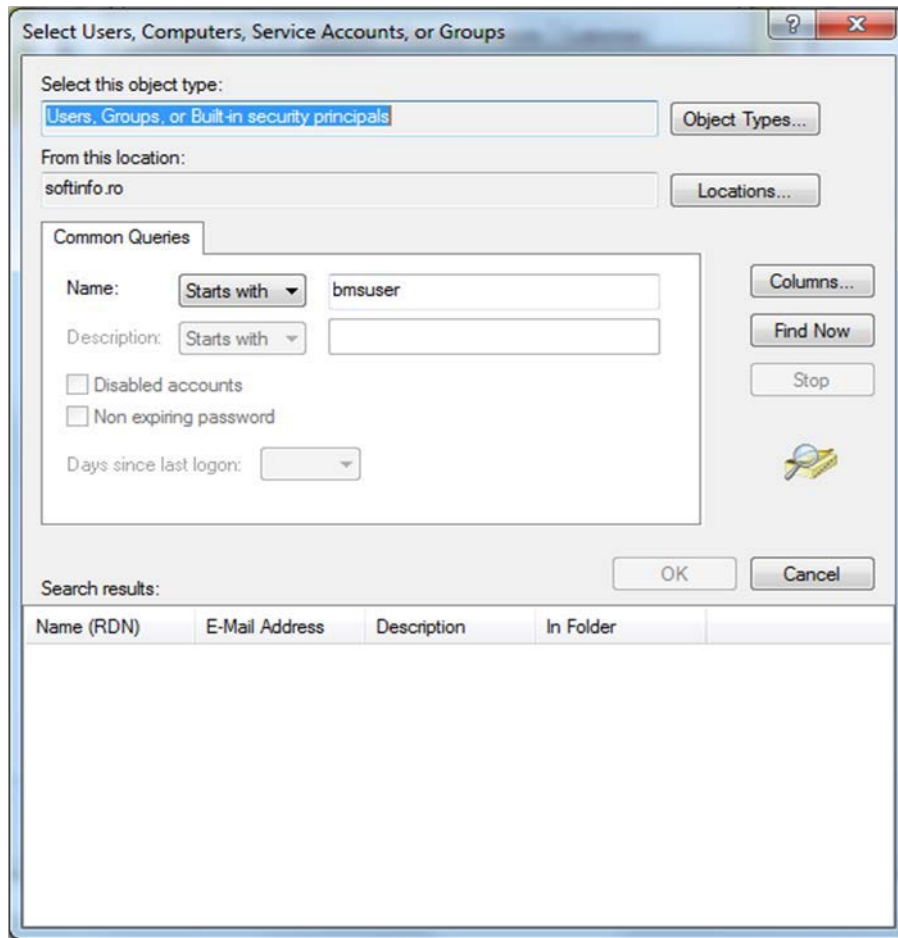

Figure 25: Advanced Section of Select Users or Groups Window

- Enter the name of the user (*aac\bms\_svc\_prod*) that runs the two BMS Windows Services. Click Find Now button.

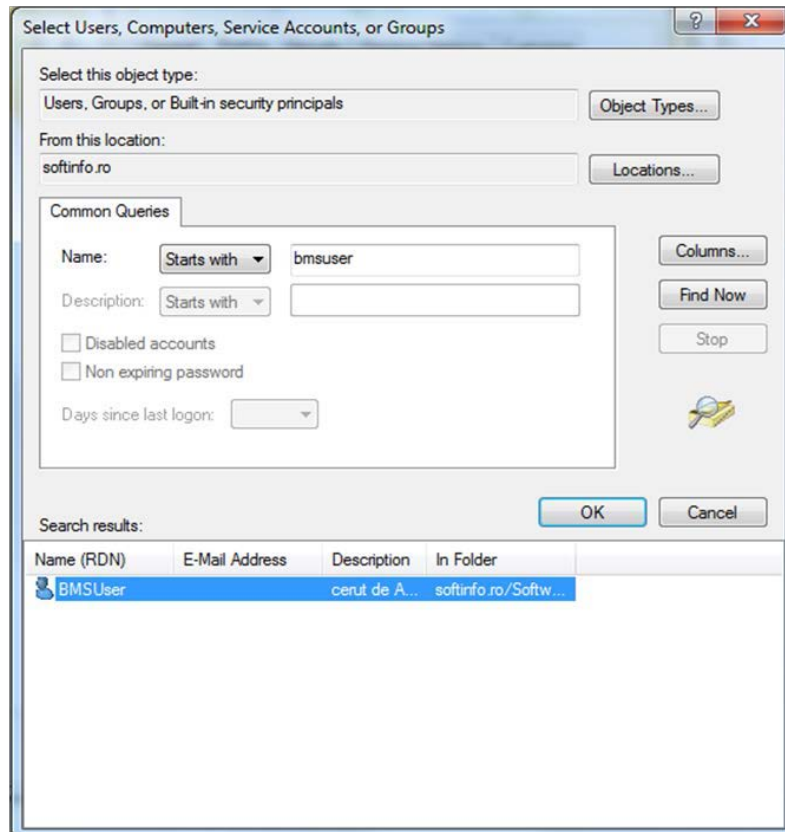

Figure 26: Search Result Section

- *Scroll down the Search results section to select the user. Once done, click OK. It will add the user within the object names section.*

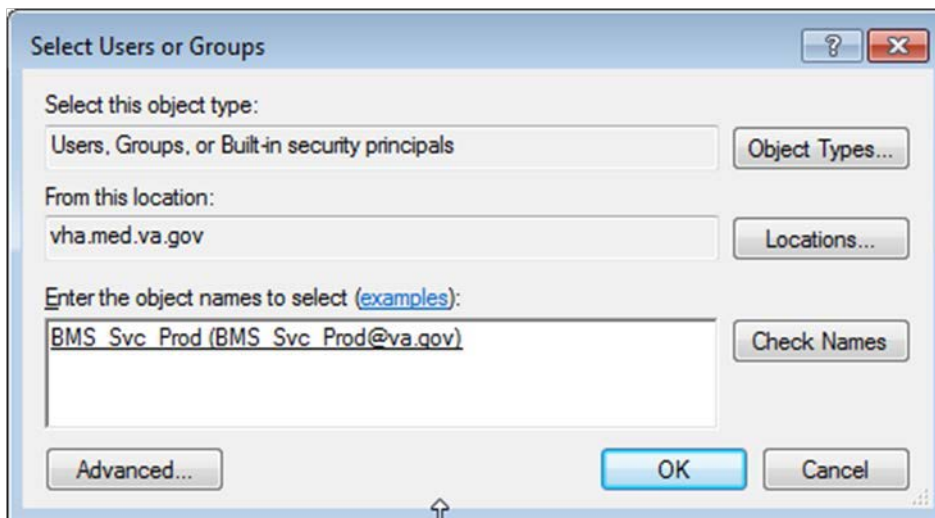

Figure 27: Object Names Section

Clicking OK will add folder access permission for user and takes you back to Permissions dialog, allowing you to configure the permissions for newly added users.

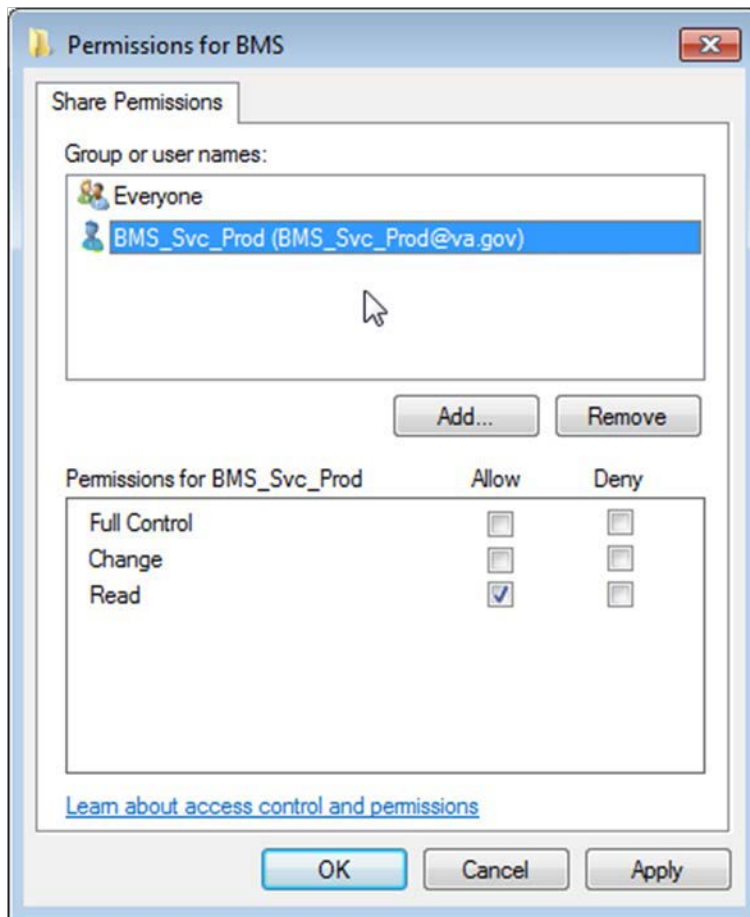

Figure 28: Permissions Window

- Select user, and from Permissions section check Full Control.



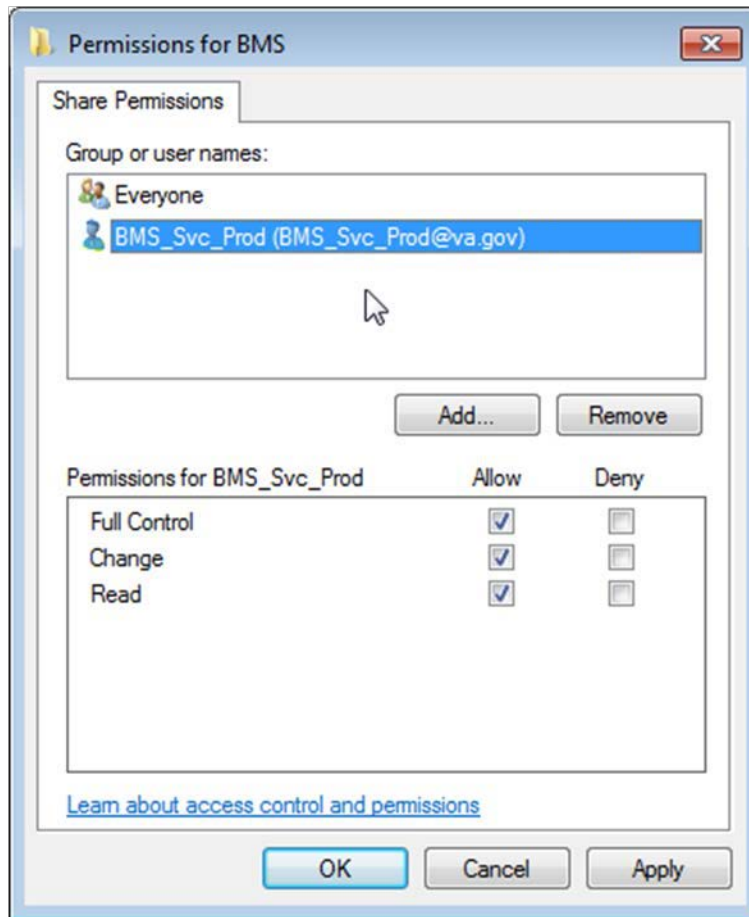

Figure 29: User Permissions

- *Click Ok to close Permissions window. It will take you back to Advanced Sharing window.*

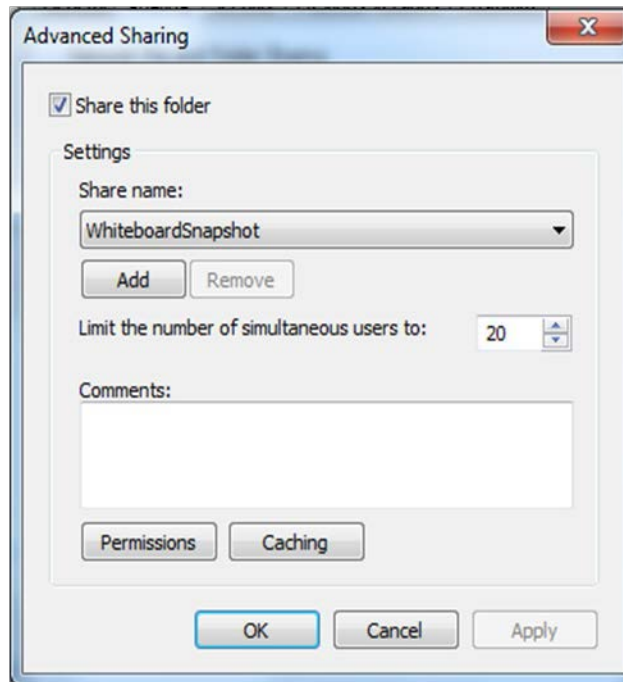

Figure 30: Advanced Sharing Window

- Now, click *OK* to share the folder.
- Close *Whiteboard Snapshot* properties window.

Having these two folders shared and having that user given the rights previously mentioned, if someone is logged in the network with that user, he/she could access those folders from Windows Explorer using an URI address. See screenshot below:

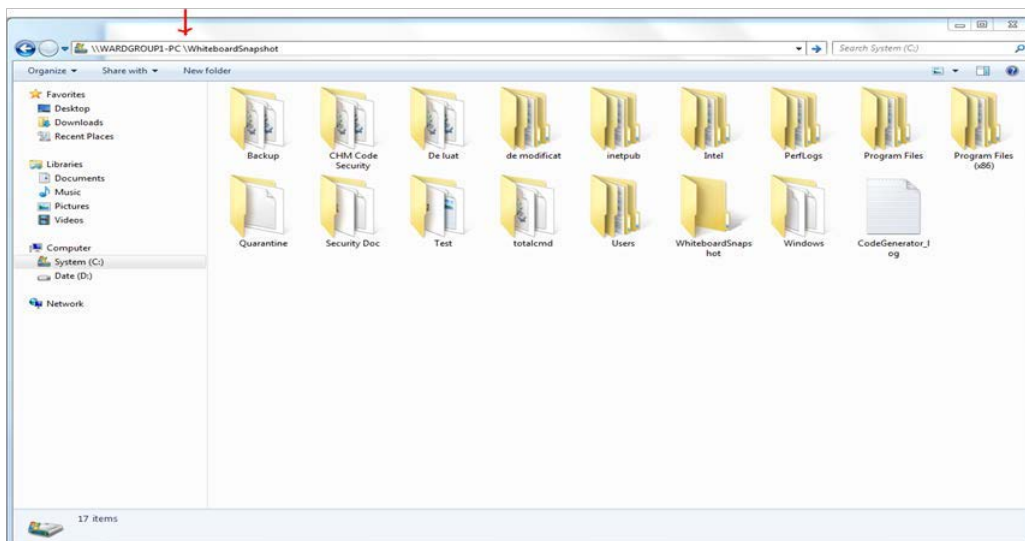

Figure 31: WardGroup1-PC Path

## 2.6.4 Assign Snapshot Folder Path to Ward Group

Within the BMS Application, under Site Settings and then Contingency Settings page, the Admin should enter the values as captured in the screenshot (\\WARDGROUP1-PC\WhiteboardSnapshot for WARD GROUP 1 and respectively \\WARDGROUP2-PC \WhiteboardSnapshot for WARD GROUP 2).

**NOTE:** The Windows User (**acc\bms\_svc\_prod**) must have full read/write access to this folder.

Ward Group	Whiteboard Report Path
WARD GROUP 1	\\WARDGROUP1-PC\WhiteboardSnapshot
WARD GROUP 2	\\WARDGROUP2-PC \WhiteboardSnapshot
WG LILI	

Figure 32: Contingency Settings Page

## 2.6.5 Associate Scheduler with Whiteboard Report

Within the BMS Application, Facility Home page, under Site Options and then Background Processors page, a Scheduler should be associated in the Whiteboard Report section.

Under the WhiteBoard Report section:

- In the “Add/Update Scheduler:” field, select the schedule frequency that Whiteboard should be backed up.
- Click Save Scheduler button.

[Return to Admin Page](#)

Figure 33: Whiteboard Report Scheduler Association

## 2.7 EMS Mobile Device Configuration

In order to configure the BMS EMS Mobile Devices, the following steps must be completed:

- The local IS must create a local Service Account with a password that never expires and does not change. This account must not have any kind of policy that restricts its use to specific computers. The EMS Mobile Device will use this account to access the EMS Mobile page. This local Service Account can be the same as the Whiteboard Kiosk Default User Account created in Section 2.5.2.
- Each facility must enter the local Service Account and Password in the EMS Default User and Password fields on the Facilities Settings page.
- Configure the Mobile Device so that when it boots up, it will automatically open IE and go to the specified URL.

### 2.7.1 Configure EMS Mobile Device Default Login User

For the current facility, a default user must be configured in the BMS application for the EMS Mobile Device.

To accomplish this, the Facility Admin User must do the following:

- Go to the Facility Home Page.
- Click on the Site Options link.
- Click on the Facility Setting link.
- Fill the fields “EMS Default User Name:”, “EMS Password:”, and “EMS Password Confirm:” with the BMS Local Service Account.

[Return to Admin Page](#)

Facility Configuration - VA NORTH TEXAS HEALTH CARE SYSTEM: DALLAS VA MEDICAL CENTER (NTX)	
PARAMETER	OPTIONS
BMS Server Time Zone	CENTRAL STANDARD TIME
Facility Site Time Zone	CST
Auto-Removal Patients Pending Bed Placement List?	Yes
Integrated Facility?	No
Facility Name:	VA NORTH TEXAS HEALTH CARE SYSTEM: DALLAS VA
Facility Address 1:	4500 S. LANCASTER RD.
Facility Address 2:	DALLAS, TEXAS 75216
Facility Point-of-Contact:	JEFFREY D ALLEN
Facility POC Email:	JEFFREYD.ALLEN@VA.GOV
Facility POC Telephone:	214 857 4607
Local Time Adjust:	0
EMS Default User Name:	vhantxbedgmt
EMS Password:	
EMS Password Confirm:	
Whiteboard Kiosk Default User Name:	vhantxbedgmt
Whiteboard Kiosk Password:	
Whiteboard Kiosk Password Confirm:	
<input type="button" value="Submit"/> <input type="button" value="Cancel"/>	

[BMS Home](#) | [Icon Legend](#) | [Information](#)

Figure 34: EMS Fields Filled on the Facility Settings Page

- Click the Submit button.

Table 16: Facility Settings Page Parameters

Column	Description
EMS Default User Name:	The BMS Service Account ID needed to load the EMS Mobile Page for Mobile Devices.
EMS Password:	The BMS Service Account ID password needed to load the EMS Mobile Page for Mobile Devices.
EMS Password confirm:	The confirmation of the password.

This setup can also be completed by the system Support User:

- Go to the BMS Admin Page
- Click on the Edit BMS Facility Settings link
- Click on the Facility Name Drop Down and select the name of the Facility to be configured
- Fill the fields “EMS Default User Name”, “EMS Password” and “EMS Password Confirm” with the BMS Local Service Account

The screenshot shows the 'ADMINISTRATION SECTION - FACILITY EDIT' page. The 'Select Facility Name' dropdown is set to 'NTX - DALLAS (949 - ACTIVE: YES)'. The facility details include: Facility Site ID: NTX, Full Facility Name: VA NORTH TEXAS HEALTH CARE SYSTEM: DALLAS VA, Facility POC Contact: JEFF ALLEN, Facility POC Email: JEFFREYD.ALLEN@VA.GOV, Facility POC Telephone: 214.857.4007, Facility Address 1: 4500 S LANCASTER RD, Facility Address 2: DALLAS, TEXAS 75216, Facility City/State/ZIP: DALLAS, TX 75216. The 'User operations' table lists two users: 'aac.dha.va.gov\1AAACSAFVJ' and 'aac.dha.va.gov\vaachemas'. The 'EMS Default User Name' is 'vhantxbsmgmt', 'EMS Password' is filled, and 'EMS Password Confirm' is filled. The 'Submit' button is at the bottom.

Figure 35: EMS Fields Filled on the BMS Admin Page

- Click the Submit button

Table 17: BMS Admin Page Parameters

Column	Description
--------	-------------

EMS Default User Name:	The BMS Service Account ID needed to load the EMS Mobile Page for Mobile Devices.
EMS Password:	The BMS Service Account ID password needed to load the EMS Mobile Page for Mobile Devices.
EMS Password confirm:	The confirmation of the password.

## 2.7.2 Configure EMS Mobile Device URL

For the current facility, the EMS Device URL must be configured in the EMS Mobile Device. The URL to be entered has a special format:  
<https://vaww.bms.va.gov/EMSMobileLogon?code=BRK>.

Table 18: Description and Configuration for EMS Mobile Device URL parameters

Parameter	Short Description	Options
Code	Code of facility (e.g. BROCKTON = BRK)	Enter the 3-character facility ID.

EMS staff can access the BMS Web page for mobile devices at the URL set up by their local IS staff. Be sure to use the code of the facility for which access is needed.

The following page is displayed:



Figure 36: EMS Staff Page for Mobile Devices

## 2.8 VistA Integration

This chapter describes the process of importing vocabularies, entities, patient admission, transfer,

discharge (ADT) and patient pending bed placement information from VistA.

In order to integrate with VistA certain steps should be completed:

1. Choose VistA site
2. Define Schedulers
3. Run Scheduler
4. View Audit Results

## 2.8.1 Choose VistA Site

VistA Sites tab from Background Processors page of Admin section allows the user to view the list of VA facility sites sharing the same VistA instance and to add a new VA facility to a VistA instance.

### 2.8.1.1 Adding a New VistA Site

To add a VA facility site to a VistA instance follow the steps presented below.

1. From the Background Processors page of Admin section select VistA Sites to display the page in the following image. A list of VA facility sites is displayed in the column to the left of the page.

The screenshot shows the 'Background Processors' page with the 'VistA Sites' tab selected. On the left, there is a list of 'Defined VistA Sites' with a scroll bar. The list includes sites like V03NYN - 630, V09LEX - 596, V11IND - 583, V17NTX - 549, V18ABQ - 501, V18AMA - 504, V18BIG - 519, V18BLP - 756, V18PHO - 644, V18PRE - 649, V18TUC - 678, V19CHY - 442, V19DEN - 554, V19FHM - 436, V19GRJ - 575, V19SHE - 666, V19SLC - 660, V20ANC - 463, V20BOI - 531, V20POR - 648, V20PUG - 663, V20ROS - 653, V20SPO - 668, and V20VCO - 692. The main form area is titled 'VistA Site' and contains the following fields and sections:

- VistA Site:**
  - Name: A dropdown menu.
  - Time Zone: A dropdown menu.
- Connections:**
  - ODBC:**
    - Connection string: A text input field with a value 'x' and a 'Test Connection' button.
    - User: A text input field with a value 'x'.
    - Password: A text input field.
  - MDWS:**
    - Mdws Endpoint: A dropdown menu with a value 'MdwsEndpointUrl\_1 - http://va' and a 'Test Connection' button.
- At the bottom right of the form are 'Save' and 'Cancel' buttons.

At the bottom of the page, there is a link: [Back to Regional Page](#) |

Figure 37: Adding a VistA Site

2. Click the Add new VistA site link then from the VistA Site area use the Name field to select the code of the site you want to add to the current VistA instance, and then select the Time Zone.

In the Connections area you can choose between two connection methods: ODBC and MDWS. Fill in the following data for the ODBC method:

Table 19: New VistA Site Parameters

Column	Description
Connection String	The connection string for the ODBC method.
User	The username for the connection.
Password	The password associated to the user account.
MDWS Endpoint	The specific instance of MDWS that the individual site will bind too.

You can use the Test Connection buttons to verify the connection and press the Save button to enter the data into the system.

The newly added site will be added in the sites list to the left of the screen.

## 2.8.2 Define Schedulers

The Schedulers tab from Background Processors page of Admin section displays a list of schedulers defined by user. It allows the user to add new schedulers, edit or remove old schedulers.

NOTE: To run the schedulers, the VistA Integration tab must be used (see next section VistA Integration for details).

The Schedulers tab is displayed as in the following image:

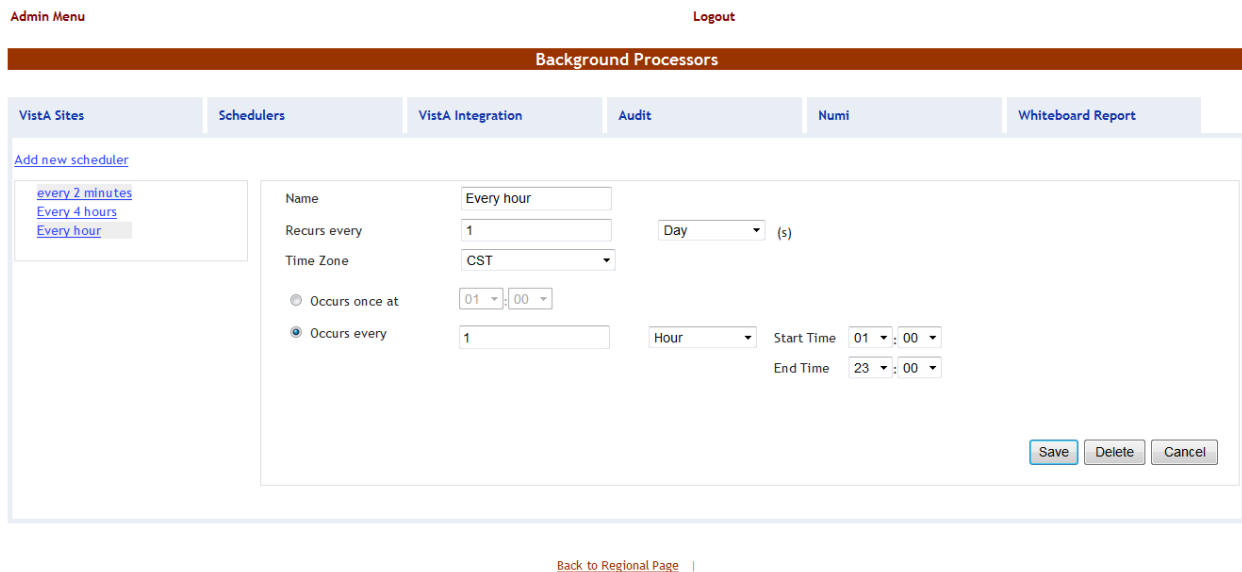

Figure 38: Schedulers Tab

### 2.8.2.1 Adding a New Scheduler

To add a new scheduler follow the steps presented below.

1. From the Background Processors page select the Schedulers tab.



2. In the Schedulers tab fill in the following data:

Table 20: New Scheduler Parameters

Column	Description
Name	The name of the scheduler.
Recurs every	The frequency.
Time Zone	Time zone associated with the scheduler.
Occurs once at/Occurs every	The frequency values.

After setting the desired frequency for the new scheduler, do not forget to press the Save button to enter the data into the system.

### 2.8.3 Run Scheduler

The VistA Integration tab is used to run (automatically or manually) the defined schedulers and to select which data categories will be affected by a scheduler’s action.

The VistA Integration tab is displayed as in the following image:

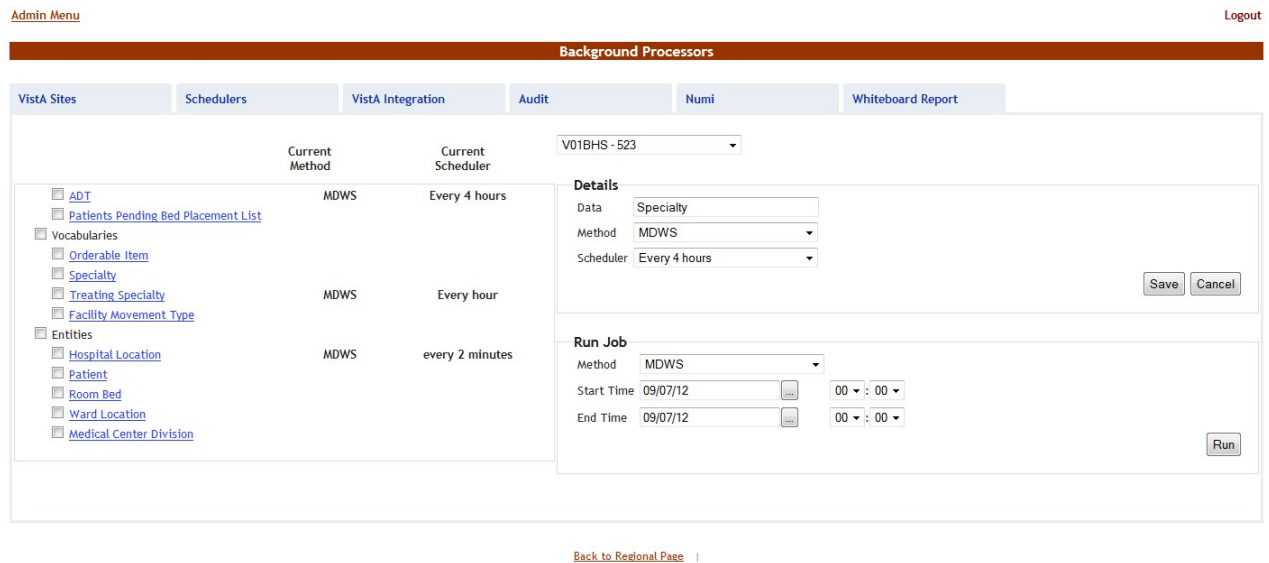

Figure 39: VistA Integration Tab

From the field in the upper part of the page select the VistA site where the scheduler(s) will run.

Next step:

- Either click one data category from the column to the left (its name will appear in the Data field) and then select a method and scheduler from the Method and Schedulers fields in the Details area: this will cause the selected scheduler to run at the time set for it in the Schedulers tab and to bring data from the selected category.

- Or select several data categories (using the check-boxes) then select a connection method from the Run Job area, set the Start time/End time and click the Run button: this will cause the scheduler set using the selected method to start running now and bring the data from the selected categories.

## 2.8.4 View Audit Results

The Audit tab displays the results of the operations performed in the VistA Integration tab.

The Audit tab is displayed as shown in the following image.

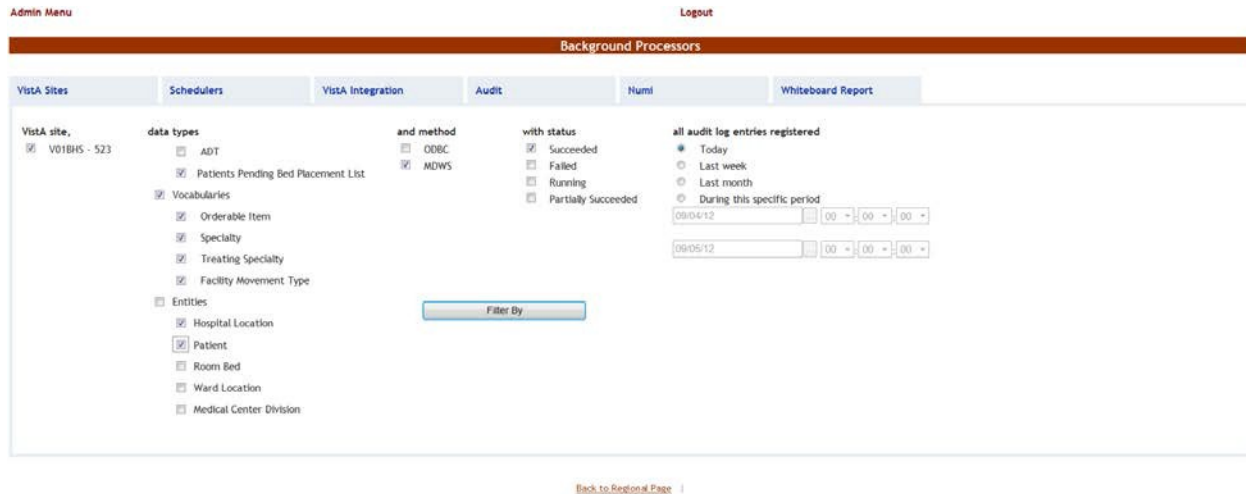

Figure 40: Audit Tab

The options to the left of the page allow the user to determine the filter criteria for the generated audit reports. The options to the right of the screen allow the user to select the type of operation to be captured by the audit report as well as the time interval for the audit.

After selecting the desired criteria, click the Filter by button to display the page as in the following image.

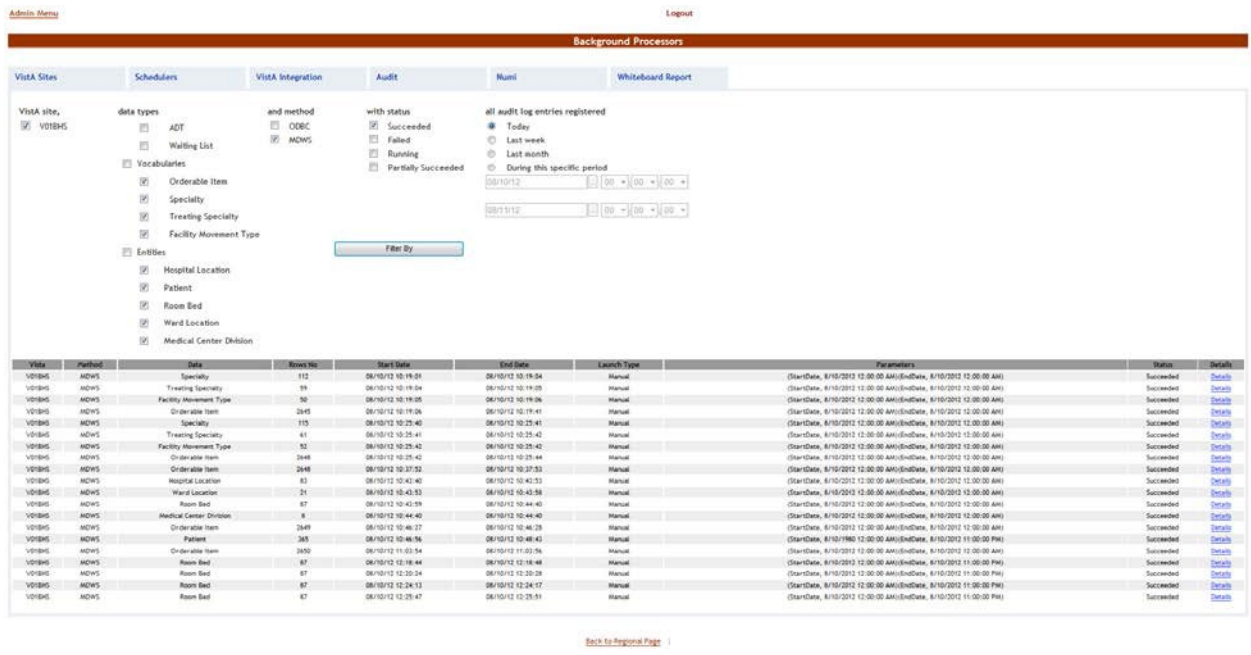

Figure 41: View Audit Results

A list of operations is displayed. For each entry the following data is available:

Table 21: View Audit Results Columns Report

Column	Description
VistA	The VistA site where the audit action has been performed.
Method	The method used for connecting to the VistA site.
Data	The type of data retrieved by the VistA integration operation.
Rows no	The number of operations of the selected type captured by the audit action.
Start Date	The start date of the retrieval operation.
End Date	The end date of the retrieval operation.
Launch Type	The way the audit action has been launched.
Parameters	Audit operation start date and time, and end date and time.
Status	The status of the VistA integration action.
Details	Clicking this link will display the number of entries in the report.

## 2.9 NUMI Integration

This chapter describes the process of importing patient level of care information from NUMI.

NUMI connects to VistA for synchronization of patient data using the NUMI Web Service that is part of the Commercial Off the Shelf McKesson product. Authentication to the NUMI Web Service is done by a NUMI supplied secret key.

NUMI Patient Level of Care transaction involves the following steps:

- Change patient level of care in NUMI.
- BMS Reader component will detect the patient level of care in NUMI.
- Patient level of care will be retrieved through a web service method call.
- BMS Writer component will update patient level of care in BMS database.

## Integration Settings

There are a limited number of configuration parameters for NUMI.

- Secret Key
- Number of sites per call
- Path to NUMI web service

These configurations are stored in BMS.Service.Host.exe.config

The current secret key is: <authorization key>

The number of site per call parameter how many sites will be bundled together in a transaction to NUMI. If this number is increased one should consider the frequency in which the calls are scheduled. Adding more sites will increase the transaction size and length.

Currently all NUMI servers operate on port 100 at the specified endpoint  
**<https://<servername>.aac.dva.va.gov/Inpatient.asmx>**.

In order to integrate with NUMI certain steps should be completed:

1. Choose VistA site
2. Define Schedulers
3. Select Scheduler

### 2.9.1 Choose VistA Site

This step is the same as the one performed on VistA Integration process and can be referenced from [Section 2.7.1](#).

### 2.9.2 Define Schedulers

The process of defining schedulers can be referenced from Vista Integration process, [Section 2.7.2](#).

### 2.9.3 Select Scheduler

The NUMI tab is used to select the scheduler that will connect to the NUMI server and will retrieve data for a certain VistA site.

The NUMI tab is displayed as in the following image.



Figure 42: NUMI Tab

From the Schedulers field select the scheduler created to retrieve the NUMI data then click the Add button: following page is displayed.

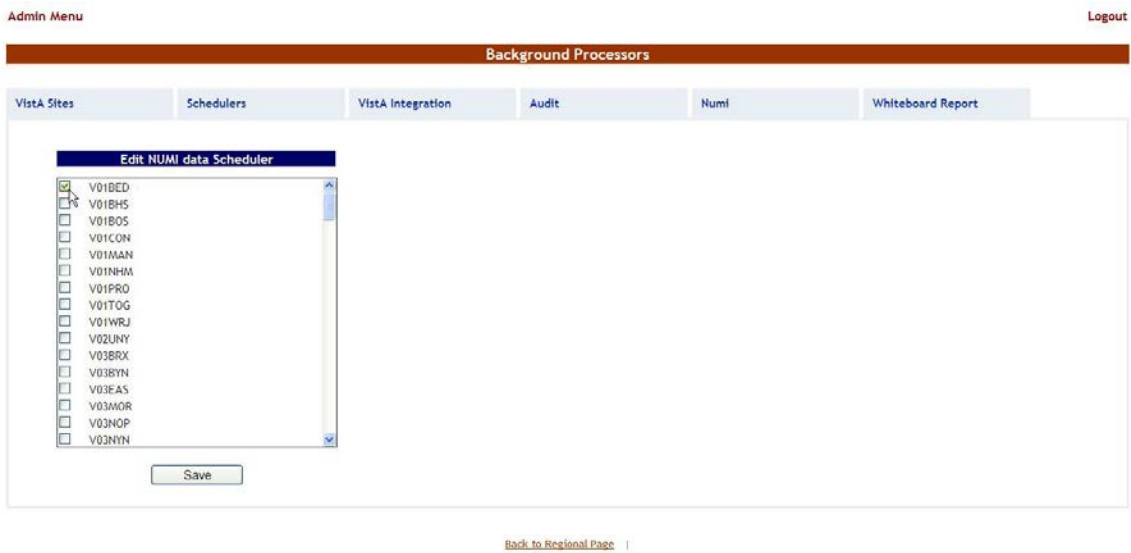

Figure 43: Selecting the Vista Site for Which to Gather NUMI Data

Select the Vista site for which the selected scheduler will retrieve NUMI data then press the Save button. Use the Edit link to select a different site for which the scheduler should retrieve NUMI data.

## 3 Application structure

### 3.1 Application Components

BMS application consists of the following components:

- BMS Databases (BMS Database, BMS Authz, BMS EIS, BMS EVS, BMS\_DS, BMS\_DW, BMS InstanceStore and BMS History)
- BMS Services (BMS Service and Win ServiceHost)
  - BMS Service

- Win Service Host (EIS Service, EVS Service, PAP service, PDP service, RS service and STS service)
- BMS Web Site
- WMI UserGroup

## 3.2 Application Directory Structure

BMS application directory is structured as is presented below:

```

+---Consoles
| +---PolicyManager
+---Databases
| \---SQLData
| | \---Job Logs
| | \---WMI_UserGroup
+---Services
| +---BMS
| | \---DBRepository
| | \---LinqToSql
| | \---LocalReportWhiteboard
| | \---Scripts
| +---EIS
| | \---DBRepository
| +---EVS
| | \---DBRepository
| +---PAP
| | \---DBRepository
| +---PDP
| +---RS
| +---Shared
| \---STS
+---WebSite
| +---bin
| | \--- LocalReportWhiteboard
| | \--- Scripts
| +---Content
| | \---images
| | +---themes
| | | +---base
| | | | \---images
| +---Reporting
| +---ReportsLocal
| +---Scripts
| \---Views

```

### 3.3 Database Architecture

The BMS Database implementation is comprised of three main parts:

- BMS Database
  - BMS\_EVS (Enterprise Vocabulary database)
  - BMS\_EIS (Entity Identification Services database)
  - BMS\_AUTHZ (Authorization database)
  - BMS (Bed Management database).
  - BMS\_History (BMS Transactional History)
  - BMS\_InstanceStore (BMS Instances)
- BMS\_DS – Data Loaded by an ETL job
- BMS\_DW - Data Loaded by an ETL job

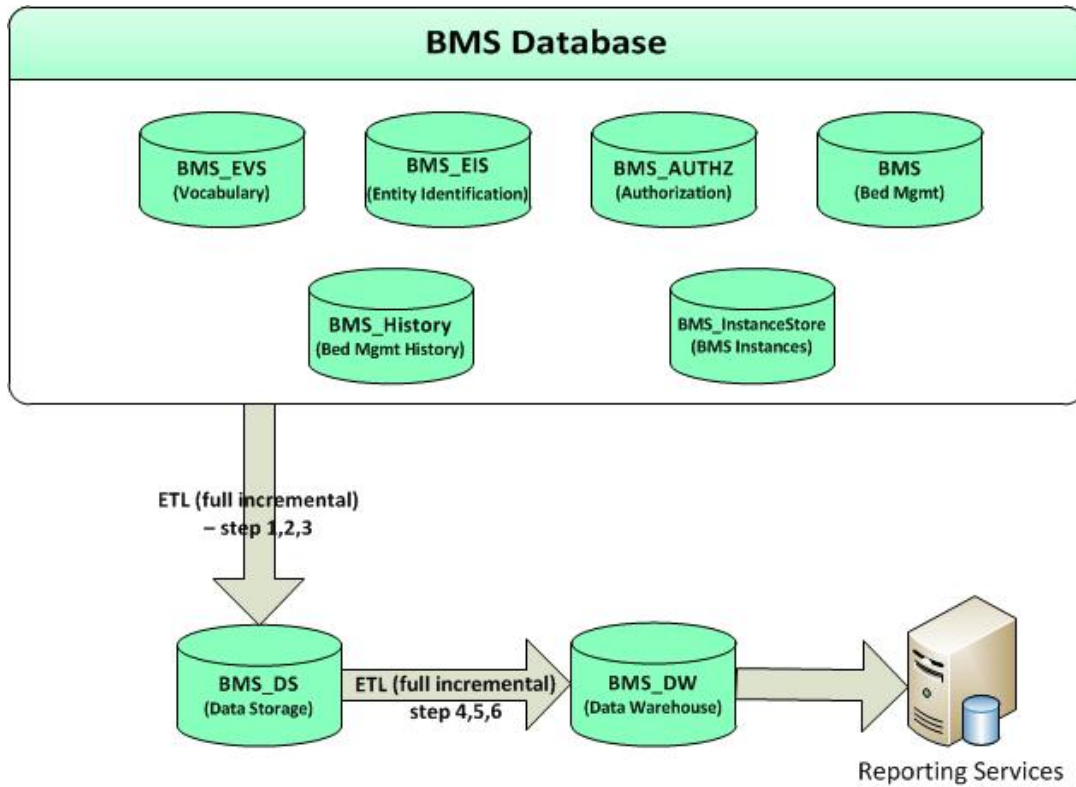

Figure 44: Database Architecture

### 3.4 Component Files

A list with files for each BMS component is presented below:

Table 22: BMS Database Files

Relative Path	File	Description
---------------	------	-------------

Relative Path	File	Description
Databases\SQLData Databases\SQLData2 Databases\SQLLogs	BMS_Data.mdf	Database files (BMS database, BMS Authz, BMS EIS, BMS EVS....)
	BMS_Data_F.ndf	
	BMS_Log.ldf	
	BMS_AUTHZ_Data.mdf	
	BMS_AUTHZ_Log.ldf	
	BMS_DS_Data.mdf	
	BMS_DS_Data_F.ndf	
	BMS_DS_Log.ldf	
	BMS_DW_Data.mdf	
	BMS_DW_Log.ldf	
	BMS_EIS_Data.mdf	
	BMS_EIS_Data_F.ndf	
	BMS_EIS_Log.ldf	
	BMS_EVS_Data.mdf	
	BMS_EVS_Data.ndf	
	BMS_EVS_Log.ldf	
	BMS_HISTORY_Data.mdf	
	BMS_HISTORY_Data_F.ndf	
	BMS_HISTORY_Log.ldf	
	BMS_InstanceStore_Data.mdf	
BMS_InstanceStore_Log.ldf		
Databases\SQLData\Job_Logs	BMS_Reports_Log.txt	BMS Report Full job file log and BMS Incremental job file log.
	BMS_Reports_Log_Incremental.txt	
Databases\SQLData\WMI_UserGroup	AdapterRepository.dll	Binaries of WMI UserGroup application.
	Common.dll	
	connectionConfiguration.config	
	Connections.SingleDatabase.dll	
	ContextWriter.dll	
	General.MT.dll	
	Infoworld.Configuration.dll	
	MiddleTier.dll	
	MS.Common.dll	



Relative Path	File	Description
	MS.Configuration.dll	
	MS.Connections.dll	
	WMI_UserGroup.exe	
	WMI_UserGroup.exe.config	
	WMI_UserGroup.vshost.exe	
	WMI_UserGroup.vshost.exe.config	
	WMI_UserGroup.vshost.exe.manifest	
Databases\SQLData\WMI_UserGroup\ DBRepository	Connections.xml	File used to set the connection to the database.
	InfoWorld.WMI_UserGroup.DTO.DTOUserGroupDomain.xml	XML mapping file which contain mapping definitions between ePractice datasets and SQL tables. The dataset is specified by setting the <MyDataSetInfo> tag. The table to interact with – specified through the <MyDataTable> tag – is defined by four commands – usually stored procedures – which represent the Create, Read, Update and Delete (CRUD) operations which can be performed on the table: select (Read), insert (Create), update (Update) and delete (Delete). Stored procedure parameters are passed from these datasets and mapped in the same XML file.

Table 23: BMS Service Files

Relative Path	File	Description
Services\BMS	AdapterRepository.dll	The binaries of the BMS Service.
	AuditTrailSender.dll	
	AuthenticationProxy.dll	
	AuthorizationSubscriber.dll	
	BMS.Contracts.dll	
	BMS.Facade.dll	
	BMS.Facade.Contracts.dll	
	BMS.Host.dll	
	BMS.MT.dll	
	BMS.MT.dll.config	
	BMS.Numi.dll	

Relative Path	File	Description
	BMS.Schedulers.dll	
	BMS.Security.dll	
	BMS.ServiceHost.exe	
	BMS.ServiceHost.exe.config	
	BMS.ServiceImplementation.dll	
	BMS.ServicesWrapper.dll	
	BMS.UnitTesting.dll	
	BMS.UnitTesting.dll.config	
	BMS.Utils.dll	
	BMS.VistaIntegration.dll	
	BMS.VistaIntegration.Cache.dll	
	BMS.VistaIntegration.Data.dll	
	BMS.VistaIntegration.HL7.dll	
	BMS.VistaIntegration.Mdws.dll	
	BMS.VistaIntegration.UnitTesting.dll	
	BMS.VistaIntegration_Accessor.dll	
	BMS.VistaWorker.dll	
	BMS.VistaWorker.Reader.dll	
	BMS.VistaWorker2.Writer.dll	
	BMS.Web.dll	
	BMS.WhiteboardReport.dll	
	BMS.Workflows.CustomActivities.dll	
	BMS.Workflows.PropertyPromotionActivity.dll	
	BMS.Workflows.WF.dll	
	Castle.Core.dll	
	Common.dll	
	connectionConfiguration.config	
	Connections.SingleDatabase.dll	
	ContextWriter.dll	
	DataUtil.dll	
	FakeltEasy.dll	
	General.MT.dll	

Relative Path	File	Description
	HL7DataTypes.dll	
	IContracts.dll	
	ICTSEdit.dll	
	Infoworld.Configuration.dll	
	InterSystems.Data.CacheClient.dll	
	log4net.dll	
	Mdws2ORM.dll	
	Microsoft.Web.Mvc.dll	
	MiddleTier.dll	
	MS.Common.dll	
	MS.Configuration.dll	
	MS.Connections.dll	
	PAPProxy.dll	
	RS.Contracts.dll	
	Saml20.dll	
	SecurityTokenCache.dll	
	trace.log	
	Tracing.dll	
	VistASites.xml	
	Xacml2.dll	
	XacmlCore.dll	
Services\BMS\DBRepository	BMS.MT.Admission.xml	XML mapping files which contains mapping definitions between ePractice datasets and SQL tables. The dataset is specified by setting the <MyDataSetInfo> tag. The table to interact with – specified through the <MyDataTable> tag – is defined by four commands – usually stored procedures – which represent the CRUD operations which can be performed on the table: select (Read), insert (Create), update (Update) and delete (Delete). Stored procedure parameters are passed from these datasets and mapped in the same XML file. Connections.xml file is used to set the connection string to BMS database.
	BMS.MT.AdmissionInfo.xml	
	BMS.MT.AdmissionLevelOfCare.xml	
	BMS.MT.BedCleanInfo.xml	
	BMS.MT.BedCleaning.xml	
	BMS.MT.BedCleanMobileInfo.xml	
	BMS.MT.BedDNDAndOOSFromVista.xml	
	BMS.MT.BedOccupancyCount.xml	
	BMS.MT.BedOccupancyInfo.xml	
	BMS.MT.BedStaff.xml	
BMS.MT.BedStaffHistory.xml		

Relative Path	File	Description
	BMS.MT.BedSwitch.xml	
	BMS.MT.BedUnavailable.xml	
	BMS.MT.BedUnavailableHistory.xml	
	BMS.MT.BedUnavailableInfo.xml	
	BMS.MT.CancelableOrderInfo.xml	
	BMS.MT.Configuration.xml	
	BMS.MT.Discharge.xml	
	BMS.MT.Diversion.xml	
	BMS.MT.EISOrganization.xml	
	BMS.MT.EmsStaff.xml	
	BMS.MT.EvacuationPatients.xml	
	BMS.MT.IconAssociation.xml	
	BMS.MT.IconAssociationInfo.xml	
	BMS.MT.IconDetail.xml	
	BMS.MT.IconInfo.xml	
	BMS.MT.IconOrder.xml	
	BMS.MT.JobAudit.xml	
	BMS.MT.JobAuditInfo.xml	
	BMS.MT.LastActInfo.xml	
	BMS.MT.LevelOfCare.xml	
	BMS.MT.LoggedUser.xml	
	BMS.MT.Movement.xml	
	BMS.MT.NewEvent.xml	
	BMS.MT.OccupiedBedInfo.xml	
	BMS.MT.PatientIconAssociation.xml	
	BMS.MT.PatientLocation.xml	
	BMS.MT.PatientsWaitingCount.xml	
	BMS.MT.PatientWaitingDateView.xml	
	BMS.MT.PatientWaitingStandardView.xml	
	BMS.MT.Transfer.xml	
	BMS.MT.TransferInfo.xml	
	BMS.MT.VistaIntegrationLog.xml	

Relative Path	File	Description
	BMS.MT.VistaOperation.xml	
	BMS.MT.WaitingListItem.xml	
	BMS.MT.WaitingListReport.xml	
	ConfigurationService.DataAccess.ConfigurationsBE.xml	
	Connections.xml	
Services\BMS\LocalReportWhiteboard	WardWhiteboard.rdlc	Ward whiteboard report file.
Services\BMS\Scripts	conditional-validation.js	JavaScript conditional validation file.

Table 24: Win Service Host Files

Relative Path	File	Description
Services\EIS	BindingExtensions.dll	Binaries of the EIS Service.
	DTOGenericService.dll	
	DTOHL7Service.dll	
	EISAuditUtil.dll	
	EISAutomaticLink.dll	
	EISCache.dll	
	EISContracts.dll	
	EISDataAccess.dll	
	EISNotifications.dll	
	EISServiceGenericImplementation.dll	
	EISServiceHL7Implementation.dll	
	EISServiceImplementation.dll	
	EISServiceImplementation.dll.config	
ICSharpCode.SharpZipLib.dll		
Services\EIS\DBRepository	Connections.xml	XML mapping files which contains mapping definitions between ePractice datasets and SQL tables. The dataset is specified by setting the <MyDataSetInfo> tag. The table to interact with – specified through the <MyDataTable> tag – is defined by four commands – usually stored procedures – which represent the CRUD operations which can be performed on the table: select
	InfoWorld.EIS.DTOGenericService.DTOAutomaticLink.xml	
	InfoWorld.EIS.DTOGenericService.DTODomain.xml	
	InfoWorld.EIS.DTOGenericService.DTOEntity.xml	
	InfoWorld.EIS.DTOGenericService.DTOEntityType.xml	(Read), insert (Create), update (Update) and delete (Delete). Stored procedure

Relative Path	File	Description
	InfoWorld.EIS.DTOGenericService.DTOEntityTypeClassifier.xml	parameters are passed from these datasets and mapped in the same XML file. Connections.xml file is used to set the connection string to BMS_EIS database.
	InfoWorld.EIS.DTOGenericService.DTOEntityTypeTraitCoresp.xml	
	InfoWorld.EIS.DTOGenericService.DTOTrait.xml	
	InfoWorld.EIS.DTOGenericService.DTOTraitAssignment.xml	
	InfoWorld.EIS.DTOGenericService.EntityManagement.DTOEntityManageLink.xml	
	InfoWorld.EIS.DTOGenericService.EntityManagement.DTOEntityMerge.xml	
	InfoWorld.EIS.DTOGenericService.EntityManagement.DTOEntitySetStatus.xml	
	InfoWorld.EIS.DTOGenericService.LinkAlgorithmManagement.LinkAlgorithmTrait.xml	
	InfoWorld.EIS.DTOGenericService.LinkAlgorithmManagement.LinkAlgorithmTraits.xml	
	InfoWorld.EIS.DTOGenericService.LinkAlgorithmManagement.Match.xml	
	InfoWorld.EIS.DTOGenericService.QueryFunctions.DTOConflictingEntities.xml	
	InfoWorld.EIS.DTOGenericService.QueryFunctions.DTOFindEntity.xml	
	InfoWorld.EIS.DTOGenericService.QueryFunctions.DTOGetAllInfoPar.xml	
	InfoWorld.EIS.DTOGenericService.QueryFunctions.DTOGetAllInformationForAnEntity.xml	
	InfoWorld.EIS.DTOGenericService.QueryFunctions.DTOGetSupportedDomains.xml	
	InfoWorld.EIS.DTOGenericService.QueryFunctions.DTOLinkedEntities.xml	
	InfoWorld.EIS.DTOHL7Service.Address.xml	
	InfoWorld.EIS.DTOHL7Service.Container.xml	
	InfoWorld.EIS.DTOHL7Service.ContainerFiltr.xml	
	InfoWorld.EIS.DTOHL7Service.ContainerInfo.xml	
	InfoWorld.EIS.DTOHL7Service.Device.xml	
	InfoWorld.EIS.DTOHL7Service.DeviceFiltr.xml	
	InfoWorld.EIS.DTOHL7Service.DeviceInfo.xml	

Relative Path	File	Description
	InfoWorld.EIS.DTOHL7Service.ManufacturedMaterial.xml	
	InfoWorld.EIS.DTOHL7Service.ManufacturedMaterialFiltr.xml	
	InfoWorld.EIS.DTOHL7Service.ManufacturedMaterialInfo.xml	
	InfoWorld.EIS.DTOHL7Service.Material.xml	
	InfoWorld.EIS.DTOHL7Service.MaterialFiltr.xml	
	InfoWorld.EIS.DTOHL7Service.MaterialInfo.xml	
	InfoWorld.EIS.DTOHL7Service.NonPersonLivingSubject.xml	
	InfoWorld.EIS.DTOHL7Service.NonPersonLivingSubjectFiltr.xml	
	InfoWorld.EIS.DTOHL7Service.NonPersonLivingSubjectInfo.xml	
	InfoWorld.EIS.DTOHL7Service.Organization.xml	
	InfoWorld.EIS.DTOHL7Service.OrganizationFiltr.xml	
	InfoWorld.EIS.DTOHL7Service.OrganizationInfo.xml	
	InfoWorld.EIS.DTOHL7Service.Person.xml	
	InfoWorld.EIS.DTOHL7Service.PersonFiltr.xml	
	InfoWorld.EIS.DTOHL7Service.PersonInfo.xml	
	InfoWorld.EIS.DTOHL7Service.Place.xml	
	InfoWorld.EIS.DTOHL7Service.PlaceFiltr.xml	
	InfoWorld.EIS.DTOHL7Service.PlaceInfo.xml	
	InfoWorld.EIS.DTOHL7Service.Telecom.xml	
	InfoWorld.WSEventing.DTO.CustomSubscriptions.xml	
	InfoWorld.WSEventing.DTO.Endpoints.xml	
	InfoWorld.WSEventing.DTO.FilterDialects.xml	
	InfoWorld.WSEventing.DTO.Message.xml	
	InfoWorld.WSEventing.DTO.MessageGet.xml	
	InfoWorld.WSEventing.DTO.MessageGetDeliveryTo.xml	

Relative Path	File	Description
	InfoWorld.WSEventing.DTO.Subscriptions.xml	
Services\EVS	ActionManager.dll	Binaries of EVS service.
	BindingExtensions.dll	
	CodingSystems.DAL.dll	
	Configuration.dll	
	connectionConfiguration.config	
	Connections.Common.dll	
	CTSEdit.dll	
	CTSEdit.Utils.dll	
	CTSEditBulk.dll	
	CTSExport.dll	
	CTSImport.dll	
	CTSImportProxy.dll	
	CTSService.Utils.dll	
	DTOCodeMappingEdit.dll	
	DTOMapping.dll	
	DTOMessageBrowser.dll	
	DTOMessageEdit.dll	
	DTOMessageRuntime.dll	
	DTOVocabularyEdit.dll	
	DTOVocabularyEdit.dll.config	
	EVSWrapper.dll	
	EVSWrapper.dll.config	
	Factory.dll	
	HL7DataTypes.XmlSerializers.dll	
	IContracts.dll	
	ICSharpCode.SharpZipLib.dll	
ICTSEdit.dll		
ICTSEditBulk.dll		
ICTSExport.dll		
	ICTSImport.dll	



Relative Path	File	Description
	IEventing.dll	
	MappingImpl.dll	
	Message.dll	
	MessageImpl.dll	
	MessageImpl.dll.config	
	MS.Caching.dll	
	Notify.dll	
	SecureChannel.dll	
	Security.Null.dll	
	securityConfiguration.config	
	VocabularyBrowser.DTO.dll	
	VocabularyImpl.dll	
	VocabularyRuntime.DTO.dll	
	XamlContracts.dll	
	XamlDataContracts.dll	
	XamlImpl.dll	
Services\EVS\DBRepository	Connections.xml	
	InfoWorld.EVS.CTSEdit.DTO.Association.xml	
	InfoWorld.EVS.CTSEdit.DTO.CodingSystem.xml	
	InfoWorld.EVS.CTSEdit.DTO.Concept.xml	
	InfoWorld.EVS.CTSEdit.DTO.ConceptAssociationsToCMultiAttrib.xml	
	InfoWorld.EVS.CTSEdit.DTO.ConceptProperty.xml	
	InfoWorld.EVS.CTSEdit.DTO.DSMap.xml	
	InfoWorld.EVS.CTSEdit.DTO.DSMapEntry.xml	
	InfoWorld.EVS.CTSEdit.DTO.DTOReExpandValueSet.xml	
	InfoWorld.EVS.CTSEdit.DTO.DTOValueSet.xml	
	InfoWorld.EVS.CTSEdit.DTO.DTOVocabularyDomain.xml	
	InfoWorld.EVS.CTSEdit.DTO.Relation.xml	
	InfoWorld.EVS.CTSEdit.DTO.ValueSets.xml	
	InfoWorld.EVS.CTSEdit.DTO.ValueSets.xml	XML mapping files which contains mapping definitions between ePractice datasets and SQL tables. The dataset is specified by setting the <MyDataSetInfo> tag. The table to interact with – specified through the <MyDataTable> tag – is defined by four commands – usually stored procedures – which represent the CRUD operations which can be performed on the table: select (Read), insert (Create), update (Update) and delete (Delete). Stored procedure parameters are passed from these datasets and mapped in the same XML file. Connections.xml file is used to set the connection string to BMS_EVS database.

Relative Path	File	Description
	InfoWorld.EVS.CTSMAPI.DTO.CodeSystemInfo.xml	
	InfoWorld.EVS.CTSMAPI.DTO.DomainValueSetFiltr.xml	
	InfoWorld.EVS.CTSMAPI.DTO.DSConceptsByCode.xml	
	InfoWorld.EVS.CTSMAPI.DTO.DSConceptsByCodeProperties.xml	
	InfoWorld.EVS.CTSMAPI.DTO.DSConceptsByDesignation.xml	
	InfoWorld.EVS.CTSMAPI.DTO.DSConceptsByDesignationProperties.xml	
	InfoWorld.EVS.CTSMAPI.DTO.DSFullValueSetDescription.xml	
	InfoWorld.EVS.CTSMAPI.DTO.DSValueSetContextExpansion.xml	
	InfoWorld.EVS.CTSMAPI.DTO.DSValueSetExpansion.xml	
	InfoWorld.EVS.CTSMAPI.DTO.DSValueSetExpansionProperties.xml	
	InfoWorld.EVS.CTSMAPI.DTO.DSValueSetExpansionReverse.xml	
	InfoWorld.EVS.CTSMAPI.DTO.DSVocabularyDomainDescription.xml	
	InfoWorld.EVS.CTSMAPI.DTO.GetFillInDetailsCD.xml	
	InfoWorld.EVS.CTSMAPI.DTO.IsCodeInValueSet.xml	
	InfoWorld.EVS.CTSMAPI.DTO.ValidateCode.xml	
	InfoWorld.EVS.CTSMAPI.DTO.ValueSetCodeReference.xml	
	InfoWorld.EVS.CTSMAPI.DTO.ValueSetFiltr.xml	
	InfoWorld.EVS.CTSMAPI.DTO.VocabularyDomainFiltr.xml	
	InfoWorld.EVS.CTSMMapping.DTO.DSMapConceptCode.xml	
	InfoWorld.EVS.CTSMMapping.DTO.DSMapEntry.xml	
	InfoWorld.EVS.CTSMMapping.DTO.DSSupportedMapsFiltr.xml	
	InfoWorld.EVS.CTSVAPI.DTO.CodeSystem.xml	
	InfoWorld.EVS.CTSVAPI.DTO.CodeSystemFiltr.xml	
	InfoWorld.EVS.CTSVAPI.DTO.CodingSchemeFiltr.xml	
	InfoWorld.EVS.CTSVAPI.DTO.ConceptCodeValid.xml	

Relative Path	File	Description
	InfoWorld.EVS.CTSVAPI.DTO.ConceptDescription.xml	
	InfoWorld.EVS.CTSVAPI.DTO.ConceptExpansion.xml	
	InfoWorld.EVS.CTSVAPI.DTO.ConceptProperties.xml	
	InfoWorld.EVS.CTSVAPI.DTO.ConceptsByDesignation.xml	
	InfoWorld.EVS.CTSVAPI.DTO.ConceptsByProperty.xml	
	InfoWorld.EVS.CTSVAPI.DTO.Designation.xml	
	InfoWorld.EVS.CTSVAPI.DTO.RelatedConcepts.xml	
	InfoWorld.EVS.DTOEditBulk.ConceptBulk.xml	
	InfoWorld.EVS.DTOEditBulk.ConceptPropertyBulk.xml	
	InfoWorld.EVS.DTOEditBulk.RelationBulk.xml	
	InfoWorld.WSEventing.DTO.CustomSubscriptions.xml	
	InfoWorld.WSEventing.DTO.Endpoints.xml	
	InfoWorld.WSEventing.DTO.FilterDialects.xml	
	InfoWorld.WSEventing.DTO.Message.xml	
	InfoWorld.WSEventing.DTO.MessageGet.xml	
	InfoWorld.WSEventing.DTO.MessageGetDeliveryTo.xml	
	InfoWorld.WSEventing.DTO.Subscriptions.xml	
	XamlDataContracts.DSXamlReverse.xml	
	XamlDataContracts.RootXaml.xml	
	XamlDataContracts.XAMLFiltr.xml	
Services\PAP	ActionManager.dll	Binaries of PAP service.
	AuthorizationProxy.dll	
	Configuration.dll	
	connectionConfiguration.config	

Relative Path	File	Description
	Connections.Common.dll	

Relative Path	File	Description
	Microsoft.ApplicationBlocks.Data.dll	
	Microsoft.ApplicationBlocks.ExceptionManagement.dll	
	Microsoft.ApplicationBlocks.ExceptionManagement.Interfaces.dll	
	Microsoft.Practices.EnterpriseLibrary.Common.dll	
	Microsoft.Practices.EnterpriseLibrary.ExceptionHandling.dll	
	Microsoft.Practices.EnterpriseLibrary.ExceptionHandling.Logging.dll	
	Microsoft.Practices.EnterpriseLibrary.Logging.dll	
	Microsoft.Practices.ObjectBuilder.dll	
	MS.Caching.dll	
	ObjectPickerHelper2.dll	
	PAPProxy.dll	
	PDPServiceAuthorizationManager.dll	
	PolicyAdministrationPoint.dll	
	PolicyAdministrationPoint.dll.config	
	SecureChannel.dll	
	Security.Null.dll	
Services\PAP\DBRepository	Connections.xml	XML mapping files which contains mapping definitions between ePractice datasets and SQL tables. The dataset is specified by setting the <MyDataSetInfo> tag. The table to interact with – specified through the <MyDataTable> tag – is defined by four commands – usually stored procedures – which represent the CRUD operations which can be performed on the table: select (Read), insert (Create), update (Update) and delete (Delete). Stored procedure parameters are passed from these datasets and mapped in the same XML file. Connections.xml file is used to set the connection string to BMS_AURHZ database.
	InfoWorld.DE.DataAccess.LabSet.xml	
	InfoWorld.DE.DataAccess.LabSetId.xml	
	InfoWorld.DE.DataAccess.SentStatus.xml	
	InfoWorld.WSEventing.DTO.CustomSubscriptions.xml	
	InfoWorld.WSEventing.DTO.Endpoints.xml	
	InfoWorld.WSEventing.DTO.FilterDialects.xml	
	InfoWorld.WSEventing.DTO.Message.xml	
	InfoWorld.WSEventing.DTO.MessageGet.xml	
	InfoWorld.WSEventing.DTO.MessageGetDeliveryTo.xml	
	InfoWorld.WSEventing.DTO.Subscriptions.xml	

Relative Path	File	Description
Services\PDP	PolicyDecisionPoint.dll.config	Binaries of PDP service.
Services\RS	AuthorizationProxy.dll	Binaries of RS service.
	RS.Contracts.dll	
	RS.Proxy.dll	
	RS.ServiceImplementation.dll	
	RS.ServiceImplementation.dll.config	
Services\Shared	7zip.dll	Shared binaries by BMS Service and Win Service.
	AdapterRepository.dll	
	AuditTrailSender.dll	
	AuthorizationSubscriber.dll	
	BindingExtensions.dll	
	Common.dll	
	CommonResources.dll	
	Connections.SingleDatabase.dll	
	ContextWriter.dll	
	DataUtil.dll	
	General.MT.dll	
	HL7CDA.dll	
	HL7CMET.dll	
	HL7DataTypes.dll	
	ICSharpCode.SharpZipLib.dll	
	Infoworld.Configuration.dll	
	log4net.dll	
	MiddleTier.dll	
	MS.Common.dll	
	MS.Configuration.dll	
	MS.Connections.dll	
MS.Security.dll		
Saml20.dll		
SecurityTokenCache.dll		
<b>Relative Path</b>	<b>File</b>	<b>Description</b>
	Tracing.dll	

	WSEventing.dll	
	WSEventing.DataAccess.dll	
	WSEventing.DTO.dll	
	Xacml2.dll	
	XacmlCore.dll	
Services\STS	SecureTokenService.dll	Binaries of STS service.
	SecureTokenService.dll.config	
Services	WinServiceHost.exe	WinServiceHost files.
	WinServiceHost.exe.config	
	BMS-Services.log	

Table 25: BMS Web Site Files

Relative Path	File	Description
WebSite	CacheService.svc	The binaries of the BMS Web Site, web site configuration file.
	Global.asax	
	packages.config	
	Web.config	
	WebTrace.log	
	additional_login_msg.txt	Dynamic text for main login page
WebSite\bin	AntiXSSLibrary.dll	Web site's binaries.
	AuditTrailSender.dll	
	AuthenticationProxy.dll	
	BMS.Contracts.dll	
	BMS.Facade.Contracts.dll	
	BMS.Facade.dll	
	BMS.PAPContracts.dll	
	BMS.Security.dll	
	BMS.ServicesWrapper.dll	
	BMS.Utils.dll	
	BMS.Web.dll	
	EISContracts.dll	
	HL7DataTypes.dll	
	HtmlAgilityPack.dll	

Relative Path	File	Description
	HtmlSanitizationLibrary.dll	
	IContracts.dll	
	ICTSEdit.dll	
	Infoworld.Configuration.dll	
	log4net.dll	
	log4netAsync.dll	
	Microsoft.ReportViewer.Common.dll	
	Microsoft.ReportViewer.DataVisualization.dll	
	Microsoft.ReportViewer.ProcessingObjectModel.dll	
	Microsoft.ReportViewer.WebForms.dll	
	Microsoft.Web.Infrastructure.dll	
	Microsoft.Web.Mvc.dll	
	RS.Contracts.dll	
	Saml20.dll	
	SecurityTokenCache.dll	
	System.Web.Helpers.dll	
	System.Web.Mvc.dll	
	System.Web.Razor.dll	
	System.Web.WebPages.Deployment.dll	
	System.Web.WebPages.dll	
	System.Web.WebPages.Razor.dll	
	Tracing.dll	
	Xacml2.dll	
	XacmlCore.dll	
WebSite\bin\LocalReportWhiteboard	WardWhitebord.rdlc	Ward Whiteboard report file.
WebSite\bin\Scripts	Conditional-validation.js	File used by the site for conditional validation.
WebSite\Content	bundleCss.chirp.config	Images, themes and styles.
	Controls.css	
	LayoutCss.min.css	
	LayoutVistaIntegrationCss.min.css	
	Reports.min.css	
	Site.css	
WebSite\Content\images	add_tab_24.png	Images used by site.
	arrow_down.png	
	arrow_up.png	

Relative Path	File	Description
	BMSLogoV6.jpg	
	check_inv.png	
	edit_staff_cancel.png	
	edit_staff_save.png	
	FavIcon.ico	
	Info.png	
	Ladybug.png	
	login_logo.png	
	logo.png	
	order_down.png	
	order_up.png	
	sort_down.png	
	sort_up.png	
WebSite\Content\themes\base	jquery.ui.accordion.css	jQuery controls style-sheets files.
	jquery.ui.all.css	
	jquery.ui.autocomplete.css	
	jquery.ui.base.css	
	jquery.ui.button.css	
	jquery.ui.core.css	
	jquery.ui.datepicker.css	
	jquery.ui.dialog.css	
	jquery.ui.progressbar.css	
	jquery.ui.resizable.css	
	jquery.ui.selectable.css	
	jquery.ui.slider.css	
	jquery.ui.tabs.css	
	jquery.ui.theme.css	
WebSite\Content\themes\base\images	ui-bg_flat_0_aaaaaa_40x100.png	Images
	ui-bg_flat_75_ffffff_40x100.png	
	ui-bg_glass_55_fbf9ee_1x400.png	
	ui-bg_glass_65_ffffff_1x400.png	
	ui-bg_glass_75_dadada_1x400.png	
	ui-bg_glass_75_e6e6e6_1x400.png	
	ui-bg_glass_95_fef1ec_1x400.png	
	ui-bg_highlight-soft_75_ccccc_1x100.png	
	ui-icons_222222_256x240.png	
	ui-icons_2e83ff_256x240.png	
	ui-icons_454545_256x240.png	
	ui-icons_888888_256x240.png	
	ui-icons_cd0a0a_256x240.png	
WebSite\Reporting	EvacuationPatientReportViewer.aspx	
	LocalReportViewer.aspx	
	ReportError.aspx	



Relative Path	File	Description
	ReportViewer.aspx	
WebSite\ ReportsLocal	BedStatusReport.rdlc	Bed Status Report file.
WebSite\Scripts	antiForgeryToken.js	JavaScript files.
	bundleScripts.chirp.config	
	conditional-validation.js	
	element-change.js	
	hoverIntent.js	
	jquery.autosize.js	
	jquery.base64.js	
	jquery.base64.min.js	
	jquery.jscrollpane.min.js	
	jquery.maskedinput-1.3.min.js	
	jquery.mousewheel.js	
	jquery.tablescroll.js	
	jquery.tablescroll.min.js	
	jquery.tablesorter.js	
	jquery.tablesorter.min.js	
	jquery.ui.autocomplete.js	
	jquery.ui.core.js	
	jquery.ui.position.js	
	jquery.ui.progressbar.js	
	jquery.ui.widget.js	
	jquery.unobtrusive-ajax.js	
	jquery.unobtrusive-ajax.min.js	
	jquery.validate.js	
	jquery.validate.min.js	
	jquery.validate.unobtrusive.js	
	jquery.validate.unobtrusive.min.js	
	jquery.validate-vsdoc.js	
	jquery-1.5.1.js	
	jquery-1.5.1.min.js	
	jquery-1.5.1-vsdoc.js	
	jquery-1.7.1.js	
	jquery-1.7.1.min.js	
	jquery-ui-1.8.11.js	
	jquery-ui-1.8.11.min.js	
	jquery-ui-1.8.18.custom.js	
	json2.js	
	LayoutAdminAutoCompleteAndDatePicker.js	
	LayoutAdminScripts.min.js	
	LayoutAutoCompleteAndDatePicker.js	
	LayoutScripts.min.js	
	LayoutVistaIntegrationDatePicker.js	
	LayoutVistaIntegrationScripts.min.js	
	MicrosoftAjax.debug.js	
	MicrosoftAjax.js	

Relative Path	File	Description
	MicrosoftMvcAjax.debug.js	
	MicrosoftMvcAjax.js	
	MicrosoftMvcValidation.debug.js	
	MicrosoftMvcValidation.js	
	modernizr-1.7.js	
	modernizr-1.7.min.js	
	Reports.min.js	
	superfish.js	
	supersubs.js	
	whiteboard-script.js	
	whiteboard-script.min.js	
WebSite\Views	_ViewStart.cshtml	User Interface views.
	Web.config	
WebSite\Views\Account	LogOff.cshtml	Login/Logout user interface views.
	LogOn.cshtml	
WebSite\Views\Admin	AddEditUser.cshtml	Admin section user interface views.
	AddUserOperations.cshtml	
	CacheConfirmation.cshtml	
	FacilityEdit.cshtml	
	FacilityEditSaved.cshtml	
	Index.cshtml	
	RefreshUsersConfirmation.cshtml	
	RemoveUserOperations.cshtml	
	SelectUser.cshtml	
	SisterSiteAddEdit.cshtml	
	SisterSiteEditSaved.cshtml	
	UserEditHasSaved.cshtml	
	UserOperationsView.cshtml	
WebSite\Views\AdminSpecialtyAssociation	Delete.cshtml	Admin specialty association user interface views.
	Index.cshtml	
WebSite\Views\AdminUnavailableReason	AddConfirmation.cshtml	Admin unavailable reason user interface
	Delete.cshtml	
	DeleteConfirmation.cshtml	
	Edit.cshtml	
	EditConfirmation.cshtml	
	Index.cshtml	
	MissingUnavailableReasonText.cshtml	
	UnavailableReasonAlreadyExists.cshtml	
	UnavailableReasonList.cshtml	
WebSite\Views\AdminComments	Index.cshtml	
	NotifyChange.cshtml	
WebSite\Views\AdminWaitingArea	AddAction.cshtml	Admin waiting area user interface views.
	Delete.cshtml	

Relative Path	File	Description
	DeleteAction.cshtml	
	Edit.cshtml	
	EditAction.cshtml	
	Index.cshtml	
WebSite\Views\AdminWhiteboardReport	Delete.cshtml	Admin whiteboard report user interface
	Edit.cshtml	
	Index.cshtml	
WebSite\Views\AdtOrderableItems	Confirmation.cshtml	ADT Orderable Items user interface views.
	Index.cshtml	
	OrderableItemsList.cshtml	
WebSite\Views\BackgroundProcessors	AddEditConfirmation.cshtml	Background Processors user interface views.
	DeleteConfirmation.cshtml	
	Index.cshtml	
WebSite\Views\BedBoard	Index.cshtml	VISN user interface views.
WebSite\Views\BedBoardModule	Index.cshtml	Bed Board Module user interface view.
WebSite\Views\BedInformation	ClearAll.cshtml	Bed Information user interface views.
	Index.cshtml	
	NotifyChange.cshtml	
WebSite\Views\BedStatusReport	Index.cshtml	Patients Pending Placement Status report user interface view.
WebSite\Views\ContingencySettings	Confirmation.cshtml	Contingency settings user interface views.
	Index.cshtml	
WebSite\Views\DischargeClinic	Index.cshtml	Discharge clinic user interface views.
	MessageConfirmation.cshtml	
WebSite\Views\EmsBedStatusAdmin	Edit.cshtml	EMS bed status user interface views
	EMSBatchAssign.cshtml	
	Index.cshtml	
	SaveConfirmation.cshtml	
WebSite\Views\EMSMobile	EMSList.cshtml	EMS Mobile user interface views.
	Users.cshtml	
WebSite\Views\EMSMobileLogon	Index.cshtml	EMS Mobile Logon user interface view.
WebSite\Views\EmsNotification	AddEdit.cshtml	EMS Notification user interface views.
	AddEditAction.cshtml	
	Delete.cshtml	
	DeleteAction.cshtml	
	Index.cshtml	
WebSite\Views\EmsStaff	Delete.cshtml	EMS Staff user interface views.
	Edit.cshtml	

Relative Path	File	Description
	Index.cshtml	
WebSite\Views\EventNotification	AddConfirmation.cshtml	Event Notification user interface views
	AddEdit.cshtml	
	Delete.cshtml	
	DeleteConfirmation.cshtml	
	EditConfirmation.cshtml	
	Index.cshtml	
WebSite\Views\Exception	Index.cshtml	Exception user interface views.
	WFException.cshtml	
WebSite\Views\FacilityDiversion	Add.cshtml	Facility Diversion user interface views.
	Confirmation.cshtml	
	Edit.cshtml	
	Index.cshtml	
WebSite\Views\FacilitySettings	Index.cshtml	Facility Settings user interface views.
	SaveConfirmation.cshtml	
WebSite\Views\Home	AdmissionList.cshtml	Home user interface views.
	AdmissionSuccessRemove.cshtml	
	AdmissionSuccessUndoRemove.cshtml	
	ChangeIntegratedSiteError.cshtml	
	Edit.cshtml	
	FeeUtilizationAdmissionList.cshtml	
	Index.cshtml	
	PatientFlowAdmissionList.cshtml	
	PatientInHouseAdmissionList.cshtml	
	PatientInquiry.cshtml	
	RemoveAdmission.cshtml	
	StandardAdmissionList.cshtml	
	UndoRemoveAdmission.cshtml	
WebSite\Views\IconLegend	Index.cshtml	Icon Legend user interface view.
WebSite\Views\IconLibrary	Edit.cshtml	Icon Library user interface views.
	Index.cshtml	
	ResetConfirmation.cshtml	
	SaveConfirmation.cshtml	
WebSite\Views\Information	Index.cshtml	Information user interface view.
WebSite\Views\LogOff	Index.cshtml	LogOff user interface view.
WebSite\Views\MaintainMarquee	Index.cshtml	Maintain Marquee user interface view.
	Saved.cshtml	
WebSite\Views\NationalAndRegional	Index.cshtml	National user interface views.
	PatientListView.cshtml	

Relative Path	File	Description
WebSite\Views\NewEvents	Index.cshtml	New events user interface view.
WebSite\Views\Numi	Delete.cshtml	NUMI user interface views.
	Edit.cshtml	
	Index.cshtml	
WebSite\Views\Patient	Admission.cshtml	Patient user interface views.
	Confirmation.cshtml	
	EvacuationData.cshtml	
	GenericWfFault.cshtml	
	PatientWaitingAdd.cshtml	
	Select.cshtml	
WebSite\Views\Reports	Index.cshtml	Patient user interface views.
WebSite\Views\Shared	_Layout.cshtml	Shared user interface views.
	_LayoutAdminPages.cshtml	
	_VistaIntegrationLayout.cshtml	
	CustomWebViewPage.cs	
	Error.cshtml	
	Header.cshtml	
	HtmlHelpers.cs	
	RequiredIfHelpers.cs	
WebSite\Views\SiteList	Index.cshtml	Site list user interface view.
WebSite\Views\SiteOptions	EvacuationConfirmation.cshtml	Site options user interface views.
	Index.cshtml	
WebSite\Views\Transfer	AddEditResult.cshtml	
	AddTransfer.cshtml	
	EditTransfer.cshtml	
	FinalizeResult.cshtml	
	Index.cshtml	
WebSite\Views\Unauthorized	PermissionAuth.cshtml	Unauthorized user interface view.
WebSite\Views\UserConfiguration	Index.cshtml	User configuration views.
	SelectUser.cshtml	
	UserEditHasSaved.cshtml	
WebSite\Views\UnavailableReason	AddConfirmation.cshtml	Unavailable reason user interface views.
	Delete.cshtml	
	DeleteConfirmation.cshtml	
	Edit.cshtml	
	EditConfirmation.cshtml	

Relative Path	File	Description
	Index.cshtml	
	MissingUnavailableReasonText.cshtml	
	UnavailableReasonAlreadyExists.cshtml	
	UnavailableReasonList.cshtml	
WebSite\Views\VistaIntegration	Audit.cshtml	VistA integration user interface views.
	AuditLogEntries.cshtml	
	Categories.cshtml	
	DeleteScheduler.cshtml	
	EditScheduler.cshtml	
	EditVistASite.cshtml	
	ErrorDetail.cshtml	
	Index.cshtml	
	Schedulers.cshtml	
	VistASites.cshtml	
WebSite\Views\WaitingArea	AddAction.cshtml	
	Delete.cshtml	
	DeleteAction.cshtml	
	Edit.cshtml	
	EditAction.cshtml	
	Index.cshtml	
WebSite\Views\WardConfiguration	AddEditWardConfirmation.cshtml	Ward configuration user interface views.
	Delete.cshtml	
	DeleteConfirmation.cshtml	
	Index.cshtml	
	Wards.cshtml	
WebSite\Views\WardOccupancy	Index.cshtml	Ward occupancy user interface view.
WebSite\Views\WardWhiteboard	ClearAll.cshtml	Ward whiteboard user interface views.
	Edit.cshtml	
	Index.cshtml	
	NotifyChange.cshtml	
	WardWhiteBoard.cshtml	
	WhiteboardDataOne.cshtml	
	WhiteboardDataTwo.cshtml	
WebSite\Views\WardWhiteboardUrl	Index.cshtml	Ward whiteboard url user interface view.
WebSite\Views\WhiteboardStaff	Index.cshtml	Whiteboard staff user interface view.
WebSite\Views\_ViewStart.cshtml	_ViewStart.cshtml	

Table 26: PolicyManager Files

Relative Path	File	Description
Consoles\PolicyManager	7zip.dll	Binaries of PolicyManager application
	AdapterRepository.dll	
	AuditTrailSender.dll	
	Infoworld.Configuration.dll	
	MS.Common.dll	
	MS.Configuration.dll	
	MS.Connections.dll	
	PAPProxy.dll	
	PolicyEditor.dll	
	PolicyEditor.dll.config	
	PolicyManager.exe	
	PolicyManager.exe.config	
	ResourceSecurityProperties.dll	
	SecurityTokenCache.dll	
	WSEventing.dll	
WSEventing.DataAccess.dll		
WSEventing.DTO.dll		
Consoles\PolicyManager\ ro	PolicyEditor.resources.dll	Binaries used by Policy Manager.
	ResourceSecurityProperties.resources.dll	
Consoles\PolicyManager\ ro-RO	PolicyEditor.resources.dll	Binaries used by Policy Manager.
	ResourceSecurityProperties.resources.dll	

## 4 Archiving

All the sensitive data in the BMS solution is persisted in a collection of SQL Server Databases. Therefore the archiving process is implying the definition of maintenance plans that will regularly make backups of these databases, backups that can be restored if needed.

The maintenance plan can be defined as detailed in the following pictures:



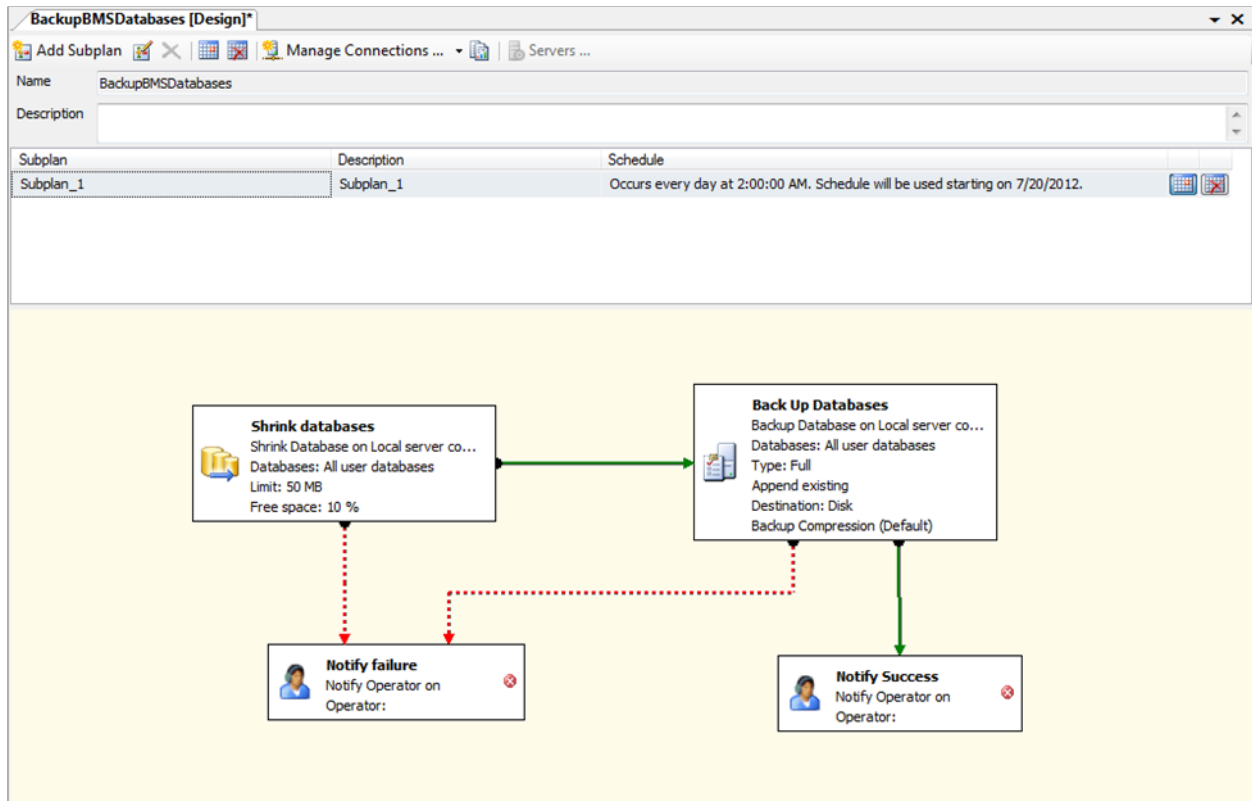

Figure 45: Backup Maintenance Plan

## 5 External Relationships

External relationships can be referenced from [External Interfaces](#) in the next section.

## 6 External Interfaces

VistA and NUMI are the external interfaces that are connected with the BMS system (see screenshot below):

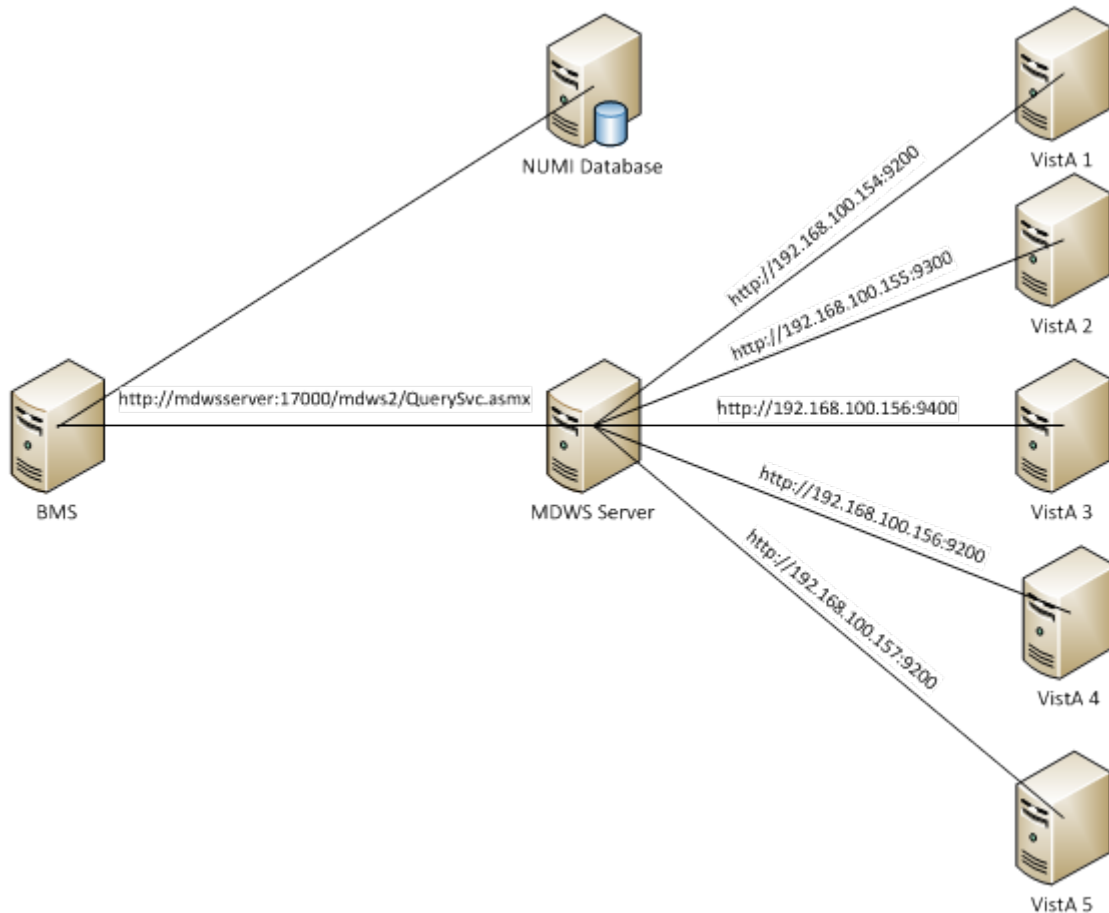

Figure 46: BMS External Interfaces

All the VISTA deployments will be connected through a Healthcare Integration Engine (MDWS version 2) to the BMS. MDWS v.2 is a suite of Service Oriented Architecture (SOA) middle-tier web services that exposes medical domain functionality, Medical Domain Objects (MDO).

In order to connect to MDWS v.2, BMS service configuration file (BMS.ServiceHost.exe.config) should be changed as follows, see *Table 4 - BMS ServiceHost Configuration Parameters* section:

- A MDWS client service endpoint should be set: `http://mdwsserver:17000/mdws2/QuerySvc.asmx`
- VistaIntegration.Enabled should be set to true: `VistaIntegration.Enabled=true`

The following configurations should be set in MDWS to be able to connect to VistA deployments:

- Application protocol: `http://192.168.100.156:9200`
- VistA DataSource connection string: `<DataSource modality="HIS" protocol="VISTA"`

```
source="192.168.100.156" status="active" port="9200"/>
```

These configurations should be done for each VistA deployment.

A connection string to NUMI database needs to be set in service configuration file (BMS.ServiceHost.exe.config), see **Table 4 - BMS ServiceHost Configuration Parameters** section:

```
<ConnectionString>Data Source=numiserver;Initial Catalog=NUMI;Integrated Security=True;</ConnectionString>
```

**NOTE:** All the configurations described above are using dummy servers and ports. Real deployment should use appropriate server, port and database connection strings.

## 7 Software Security

BMS Security is implemented at two levels:

- The first level of security consists in deciding which users have access to what pages (National/Regional, VISN, facility, EMS page).
- The second level of security refers to the read/write permissions (which are the pages a user can edit/update).

Both levels of security are implemented by means of the Policy Manager application described in the next section.

An additional level of security is provided by the domain restrictions: users can access only the BMS pages within the domain where they have been granted access rights.

The security services are based on well-established standards and practices such as:

- LDAP protocol;
- WS-Security specification;
- X509 certificates.

These services are in charge of providing for the following 'functionalities':

- CIA:
  - Confidentiality – encrypted message.
  - Integrity – message hasn't been tampered.
  - Authentication – prove identity.
- Authorization – role based access.
- Accountability – audit trail.
- Policies – mutually agreed by involved parties.

From the client application perspective, the security services are in charge of:

- Authentication:

- SAML assertions verified by the called service.
- Role based authorization:
  - Roles stored in LDAP.
  - Policies defined using XACML language.
- Record level authorization.
- Audit trail.

The audit services provide the means to address the issues of liability management, asset protection and quality of service. To facilitate a timely response to policy violations, security incidents or infrastructure and application failures, InFlow will support monitoring, logging, analysing, and reporting on every level of its architecture.

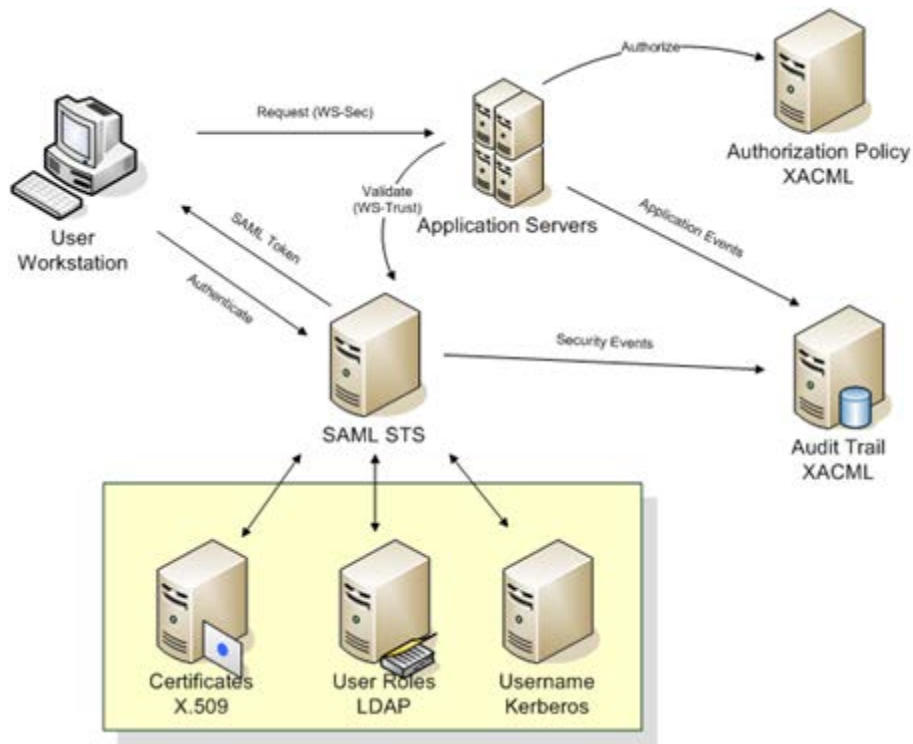
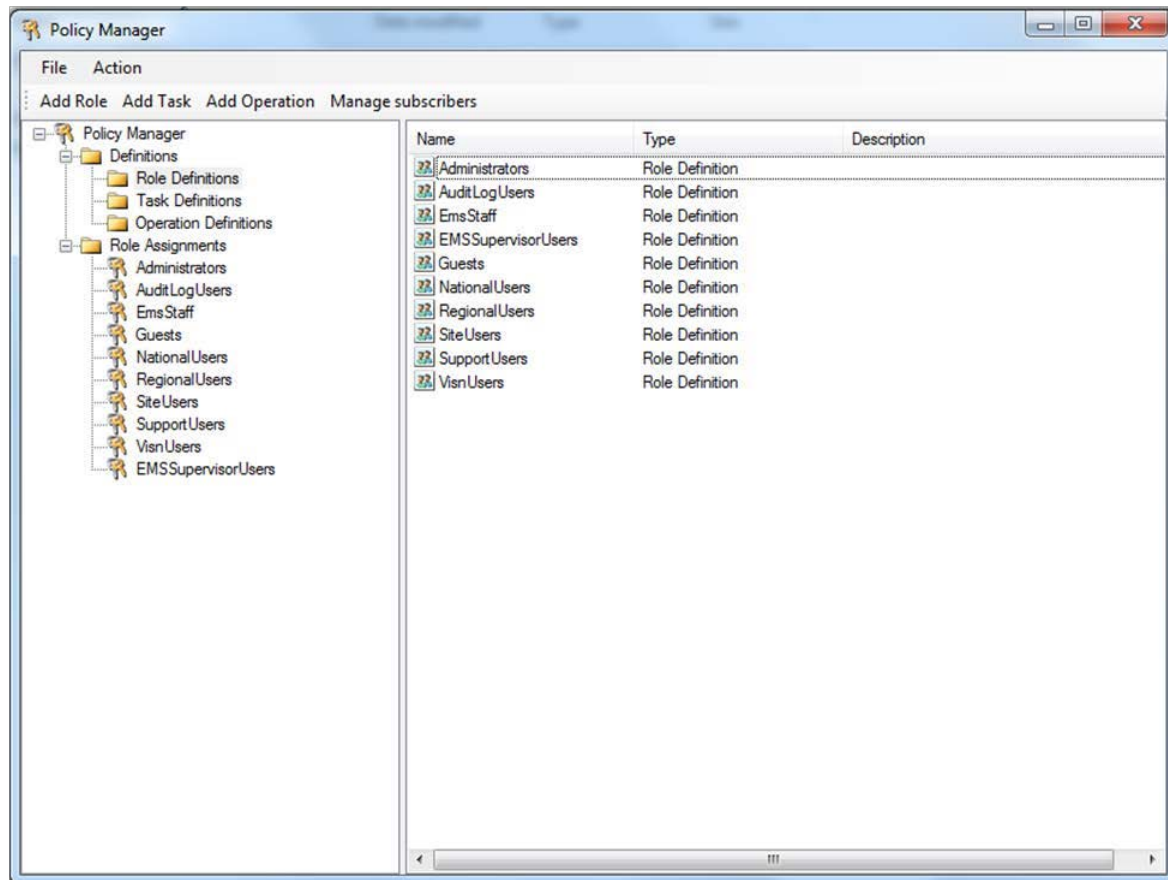

Figure 47 – Security services architecture

The security services consists of the authentication part: STS – security token service and authorization part: PAP – policy administration point and PDP – policy decision point.

## 7.1 Policy Manager

From the Console folder of your BMS solution, select Policy Manager and then double-click the PolicyManager.exe file to display the following dialog window:



*Figure 62 - Policy Manager Main Window*

The Definitions folder in the left hand panel contains the definitions of the roles, tasks and operations valid within the BMS application.

The Role Definitions folder contains the list of user roles defined within BMS.

The Task Definitions folder contains the list of tasks that can be performed within BMS and their corresponding definitions. A task usually requires the completion of several operations.

The Operation Definitions folder contains the list of operations that can be performed within BMS and their corresponding definitions.

## 7.2 Operation Definitions

To view the definition of an operation select Operation definitions from the left-hand panel of the main Policy Manager window and double-click the operation to display the following dialog window:

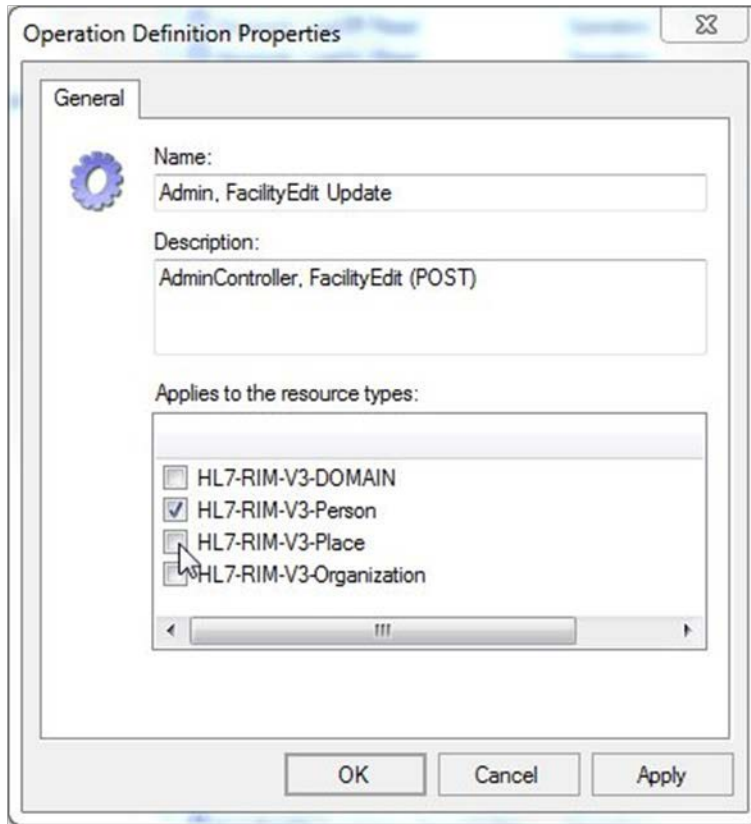

Figure 63 - Operation Definition

A list with all the operations of BMS application is presented below:

Table 27 - BMS Operations

Operation Name	Operation Description
Admin, AddEditUser Read	'Add/Edit BMS User' hyperlink from the Administration section's menu.
Admin, FacilityEdit Read	'Edit BMS Site' hyperlink from the Administration section's menu.
Admin, Index Read	'BMS Admin' hyperlink from the National And Regional Page.
Operation Name	Operation Description
Admin, SelectUser Read	'Select Existing NT User Name' button from the ADMINISTRATION SECTION - USERADD/EDIT page.
Admin, SisterSiteAddEdit Read	'Edit Sister Sites' hyperlink from the Administration section's menu.
Admin, AddUserOperations Read	'Add User' button from the ADMINISTRATION SECTION - FACILITY EDIT page (Edit BMS Site submenu).
Admin, RemoveUsers Read	'Remove Selected' button from the ADMINISTRATION SECTION - FACILITY EDIT page (Edit BMS Site submenu).
Admin, SearchUser Read	'Find' button from the 'Select user' page ('Select Existing NT User Name' button from the Administration Section menu, 'Add/Edit BMS User' submenu).
Admin, SearchUsers Read	'Find' button from the ADMINISTRATION SECTION - FACILITY EDIT page (Edit BMS Site submenu).
Admin, ClearCache Read	'Clear Cache' link from the Administration section's menu.

Admin, AddEditUser Update	'Submit' button from the ADMINISTRATION SECTION - USERADD/EDIT page.
Admin, FacilityEdit Update	'Submit' button from Administration section's menu 'Edit BMS Site' hyperlink (page ADMINISTRATION SECTION - FACILITY EDIT).
Admin, SisterSiteAddEdit Update	'Edit Sister Sites' hyperlink from the Administration section's menu, 'Submit' button.
Admin, AddUserOperations Update	'Add' button from Add users page (Add User button from the Facility page).
Admin, RemoveUserOperations Update	'Remove Selected' button from the ADMINISTRATION SECTION - FACILITY EDIT page (Edit BMS Site submenu).
AdminComments, Delete Read	'Delete' hyperlink from the Common Medical Terms page.
AdminComments, Edit Read	'Edit' hyperlink from the Common Medical Terms page.
AdminComments, Index Read	'Common Medical Terms' hyperlink from the Administration section's menu.
AdminComments, Index Update	'Save' button from the Common Medical Terms page.
AdminIcon, Delete Read	'Delete Icon' button on ADMINISTRATION SECTION - EDIT ICON page (Add/Edit Icon Submenu)
AdminIcon, Edit Read	'Edit' Link on ADMINISTRATION SECTION - ICON ADD/EDIT page (Add/Edit Icon Submenu)
AdminIcon, Index Read	'Add/Edit Icon' link on ADMINISTRATION SECTION
AdminIcon, Search Read	'Search' Link on ADMINISTRATION SECTION - ICON ADD/EDIT page (Add/Edit Icon Submenu)
AdminIcon, ViewIconReport Read	'Report' Link on ADMINISTRATION SECTION - ICON ADD/EDIT page (Add/Edit Icon Submenu)
AdminIcon, Delete Update	'Remove' button on ADMINISTRATION SECTION - DELETE ICON page (Add/Edit Icon Submenu)
AdminIcon, Edit Update	'Save' button on ADMINISTRATION SECTION - EDIT ICON page (Add/Edit Icon Submenu)
AdminIcon, Index Update	'Up/Down arrow' buttons on ADMINISTRATION SECTION - ICON ADD/EDIT page (Add/Edit Icon Submenu)
AdminSpecialtyAssociation, Delete Read	'Delete' Link on ADMINISTRATION SECTION - Treating Specialty/NUMA/HAvBED Edit page (Treating Specialty/NUMA/HAvBED Submenu)
AdminSpecialtyAssociation, Index Read	'Treating Specialty/NUMA/HAvBED' Link on ADMINISTRATION SECTION

Operation Name	Operation Description
AdminSpecialtyAssociation, Delete Update	'Delete' Button on ADMINISTRATION SECTION - Treating Specialty/NUMA/HAvBED Delete page (Treating Specialty/NUMA/HAvBED Submenu)
AdminSpecialtyAssociation, Index Update	'Save' Button on ADMINISTRATION SECTION - Treating Specialty/NUMA/HAvBED Edit page (Treating Specialty/NUMA/HAvBED Submenu)
AdminUnavailableReason, Delete Read	'Delete' link on ADMINISTRATION SECTION - National Unavailable Reason page (National Unavailable Reason Submenu)
AdminUnavailableReason, Edit Read	'Edit' link on ADMINISTRATION SECTION - National Unavailable Reason page (National Unavailable Reason Submenu)
AdminUnavailableReason, Index Read	'National Unavailable Reason' Link on ADMINISTRATION SECTION
AdminUnavailableReason, Delete Update	'Delete Record' button on ADMINISTRATION SECTION - National Unavailable Reason Delete page (National Unavailable Reason Submenu)

AdminUnavailableReason, Edit Update	'Submit' button on ADMINISTRATION SECTION - National Unavailable Reason Edit page (National Unavailable Reason Submenu)
AdminUnavailableReason, Index Update	'Add' button on ADMINISTRATION SECTION - National Unavailable Reason page (National Unavailable Reason Submenu)
AdminWaitingArea, Delete Read	'Delete' link on ADMINISTRATION SECTION - National Waiting Areas Parameter page (National Waiting Area Submenu)
AdminWaitingArea, Edit Read	'Edit' link on ADMINISTRATION SECTION - National Waiting Areas Parameter page (National Waiting Area Submenu)
AdminWaitingArea, Index Read	'National Waiting Area' Link on ADMINISTRATION SECTION
AdminWaitingArea, DeleteAction Update	'Delete Record' button on ADMINISTRATION SECTION - National Waiting Area Parameter Delete page (National Waiting Area Submenu)
AdminWaitingArea, Edit Update	'Submit' button on ADMINISTRATION SECTION - National Waiting Area Parameter Edit page (National Waiting Area Submenu)
AdminWaitingArea, Index Update	'Add' button on ADMINISTRATION SECTION - National Waiting Area Parameter page (National Waiting Area Submenu)
AdminWhiteboardReport, Delete Read	'Delete' link on ADMINISTRATION SECTION - Whiteboard Report page (Background Processor Submenu)
AdminWhiteboardReport, Edit Read	'Edit' link on ADMINISTRATION SECTION - Whiteboard Report page (Background Processor Submenu)
AdminWhiteboardReport, Index Read	'Whiteboard Report' tab on ADMINISTRATION SECTION - Background Processor page
AdminWhiteboardReport, Delete Update	'Delete Record' button on ADMINISTRATION SECTION - Whiteboard Report Delete page (Background Processor Submenu)
AdminWhiteboardReport, Edit Update	'Save' button on ADMINISTRATION SECTION - Whiteboard Report Edit page (Background Processor Submenu)
AdtOrderableItems, Index Read	Site Options, ADT Orderable Items Add/Delete hyperlink
AdtOrderableItems, Delete Update	'Delete' hyperlink from the list of orderable items.
AdtOrderableItems, Index Update	'Add' button from the Bed Board ADT Orderable Items Configuration.

Operation Name	Operation Description
BackgroundProcessors, Index Read	'Background Processors' hyperlink from Site Options page.
BackgroundProcessors, Index Update	'Save Scheduler' button from Background Processors page within Site Options.
AuditLogReport, Index Read	'View audit log' link on ADMINISTRATION SECTION
rep, Audit Log Report	Access the Audit Log Report.
BedBoard, ChangeFacility Read	Click on a facility link from the VISN Network Bed Boards list.
BedBoard, Index Read	'Return to VISN Network' hyperlink from the home page.
BedBoard, ShowFacilityBedSummaryReport Read	Click on a Facility Summary Report on VISN Network Bed Boards list
BedBoard, ShowVISNBedSummaryReport Read	Click on a VISN Summary Report on VISN Network Bed Boards list
BedBoardModule, Index Read	Site Options, Bed Board Module Enable/Disable link.



BedBoardModule, Index Update	'Submit' button from the Bed Board Module Activation and Configuration page.
BedInformation, Index Read	Ward Occupancy, click on a hyperlink from the BED column.
BedInformation, ClearAll Read	Click on button 'Clear ALL Comments For ALL Wards Associate To This Bed...'
BedInformation, NotifyChange Read	'Submit' button from the Add/Edit Bed Unavailable Reason page.
BedInformation, Index Update	Click on buttons 'Submit' and/or 'Update Reason and Comments'.
ContingencySettings, Index Read	'Contingency Settings" link on Site Settings pages.
ContingencySettings, Index Update	'Save' button on Contingency Settings page on Site Settings pages.
DischargeClinic, Index Read	Site Options, 'Discharge Appt Clinics Add/Delete' hyperlink.
DischargeClinic, Delete Update	Site Options, 'Discharge Appt Clinics Add/Delete' hyperlink, 'Delete' button.
DischargeClinic, Index Update	Site Options, 'Discharge Appt Clinics Add/Delete' hyperlink, 'Add' button.
EmsBedStatusAdmin, EMS Supervisor Read/Update	'Assigned To' drop down on EMS Bed Edit page
EmsBedStatusAdmin, EMSBatchAssign Read	'Batch Assign' button on Ems Bed Status Admin page
EmsBedStatusAdmin, EMSBatchAssign Update	'Submit' button on EMS Bed Edit page on EMS Bed Status Admin page
EmsBedStatusAdmin, Edit Read	RoomBed column link click.
EmsBedStatusAdmin, Index Read	'Return to VISN Network' link from the home page, 'Return to Regional Page' link, 'Go To Facility Bed Cleaning Page (EMS Staff Only) button.
EmsBedStatusAdmin, SaveConfirmation Read	'Submit' button click in the Environmental Management Service Bed Status page.
EmsBedStatusAdmin, Edit Update	'Submit' button click in the Environmental Management Service Bed Status page.
EMSMobile, EMSList Read	Load Bed Clean Requests on EMS Mobile Pages
EMSMobile, Users Read	Click on a User button on EMS Mobile Pages
EMSMobile, EMSList Update	Click on a Bed Clean Request button on EMS Mobile Pages
EMSMobile, Users Update	Click on Submit button after entering a PIN on EMS Mobile Pages

Operation Name	Operation Description
EmsNotification, AddEdit Read	'Edit' link from the Current Locations table (EMS Bed Notification).
EmsNotification, AddEditAction Read	'Submit' button from the EMS Bed Notification Edit page.
EmsNotification, Delete Read	'Delete' link from the Current Locations table (EMS Bed Notification).
EmsNotification, Index Read	Site Options, 'EMS Notification Add/Edit' link
EmsNotification, DeleteAction Update	'Delete Record' button from the EMS Bed Status Notification Delete page.
EmsNotification, Index Update	'Submit' button from the EMS Bed Notification Edit page or Notifications Add page.
EmsStaff, Delete Read	'Delete' link on EMS Staff page on Site Options pages
EmsStaff, Edit Read	'Edit' link on EMS Staff page on Site Options pages
EmsStaff, Index Read	EMS Staff link on Site Options page

EmsStaff, Delete Update	'Delete Record' button on Ems Staff Delete page on Site Options pages
EmsStaff, Edit Update	'Submit' button on Ems Staff Edit page on Site Options pages
EventNotification, AddConfirmation Read	'Submit' button from the Event Notification Add page.
EventNotification, AddEdit Read	'Add' button or 'Edit' link from the Event Notifications page.
EventNotification, EditConfirmation Read	'Submit' button from the Event Notifications Edit page.
EventNotification, Index Read	Site Options, 'Event Notification Add/Edit' hyperlink.
EventNotification, Index Update	'Submit' button from the Event Notification Add page.
Exception, Index Read	Appears when an exception occurs.
FacilityDiversion, Add Read	'Add' button from the Facility Diversion page.
FacilityDiversion, AddConfirmation Read	'Add' button from the Add New Diversion Status page.
FacilityDiversion, Edit Read	'Edit' link from the Facility Diversion page.
FacilityDiversion, EditConfirmation Read	'Save' button from the Diversion Status edit page.
FacilityDiversion, FilterDiversions Read	'Current Diversions' or 'All Diversions' button from the main Facility Diversions page.
FacilityDiversion, Index Read	'Facility Diversion' hyperlink from the home page.
FacilityDiversion, Index Update	'Add' button or 'Edit' link from the Facility Diversion page.
FacilitySettings, Index Read	Site Options, Facility Settings link
FacilitySettings, Index Update	Site Options, Facility Settings link, Submit button
Home, Index Read	Home page.
Home, Index2 Read	Current, Past 30-Days, Past 60-Days, Past 90-Days home page's buttons.
Home, PatientInquiry Read	Click on the patient link from the Patients Pending Placement list (Home page).
Home, RemoveAdmission Read	Remove link from the Patients Pending Placement list (Home page).
Home, UndoRemoveAdmission Read	Undo link from the Patients Pending Placement list (Home page).

Operation Name	Operation Description
Home, RemoveAdmissionPost Update	Remove link from the Patients Pending Placement list (Home page), Remove button from the confirmation page.
Home, UndoRemoveAdmissionPost Update	'Undo' button on Undo Remove Admission Page on Facility HomePage
IconLegend, Index Read	'Icon Legend' link from the bottom of the Home page or Site Options, BMS Icon Legend link.
IconLibrary, Edit Read	'Edit' Link on Site Options - Site Configurable Icons page.
IconLibrary, Index Read	Site Options, Site Configurable Icons link.
IconLibrary, ResetConfirmation Read	'Reset' button on Edit Site Configurable Icon page.
IconLibrary, Edit Update	'Save' button on Site Options - Site Configurable Icons page.
IconLibrary, Index Update	'Up/Down arrow' buttons on Site Options - Site Configurable Icons page.
IconLibrary, ResetConfirmation Update	'Reset' button on Reset Site Configurable Icon page.

Information, Index Read	'Information' link from the bottom of the Home page.
MaintainMarquee, Index Read	'Maintain Marquee Text' link from the Administration Section's menu.
MaintainMarquee, ChangeMarquee Update	'Submit' button from the ADMINISTRATION SECTION - MAINTAIN MARQUEE TEXT page.
NationalAndRegional, Index Read	Home page, Return to VISN Network link, Return to Regional Page link.
NewEvents, Index Read	Home page, New Events link.
Numi, Add Read	'Add' button on ADMINISTRATION SECTION - Background Processors page (Background Processors Submenu).
Numi, Delete Read	'Delete' Link on ADMINISTRATION SECTION - Background Processors page (Background Processors Submenu).
Numi, Edit Read	'Edit' Link on ADMINISTRATION SECTION - Background Processors page (Background Processors Submenu).
Numi, Index Read	'Numi' tab on ADMINISTRATION SECTION - Background Processors page (Background Processors Submenu).
Numi, Delete Update	'Delete Record' button on ADMINISTRATION SECTION - Background Processors Delete page (Background Processors Submenu).
Numi, Edit Update	'Save' button on ADMINISTRATION SECTION - Background Processors Add/Edit page (Background Processors Submenu).
<a href="http://tempuri.org/IAdministrativeFunctions/GetDomains">http://tempuri.org/IAdministrativeFunctions/GetDomains</a>	Functions used in the Administration Section, Add/Edit BMS User and Edit BMS Site submenus.
<a href="http://tempuri.org/IAdministrativeFunctions/GetCurrentDomain">http://tempuri.org/IAdministrativeFunctions/GetCurrentDomain</a>	
<a href="http://tempuri.org/IAdministrativeFunctions/GetRoles">http://tempuri.org/IAdministrativeFunctions/GetRoles</a>	
<a href="http://tempuri.org/IAdministrativeFunctions/GetBulkPolicies">http://tempuri.org/IAdministrativeFunctions/GetBulkPolicies</a>	
<a href="http://tempuri.org/IAdministrativeFunctions/GrantPermission">http://tempuri.org/IAdministrativeFunctions/GrantPermission</a>	
<a href="http://tempuri.org/IAdministrativeFunctions/RevokePermission">http://tempuri.org/IAdministrativeFunctions/RevokePermission</a>	

Operation Name	Operation Description
<a href="http://tempuri.org/IAdministrativeFunctions/GetRoleByName">http://tempuri.org/IAdministrativeFunctions/GetRoleByName</a>	
<a href="http://tempuri.org/IAdministrativeFunctions/GetPermissionsByResourceType">http://tempuri.org/IAdministrativeFunctions/GetPermissionsByResourceType</a>	
<a href="http://tempuri.org/IAdministrativeFunctions/GetAllUsersAndDomain">http://tempuri.org/IAdministrativeFunctions/GetAllUsersAndDomain</a>	
<a href="http://tempuri.org/IAdministrativeFunctions/GetAllUserRoles">http://tempuri.org/IAdministrativeFunctions/GetAllUserRoles</a>	
<a href="http://tempuri.org/IAdministrativeFunctions/AssignUser">http://tempuri.org/IAdministrativeFunctions/AssignUser</a>	
<a href="http://tempuri.org/IAdministrativeFunctions/DeassignUser">http://tempuri.org/IAdministrativeFunctions/DeassignUser</a>	
<a href="http://tempuri.org/IAdministrativeFunctions/GetPolicy">http://tempuri.org/IAdministrativeFunctions/GetPolicy</a>	
<a href="http://tempuri.org/IAdministrativeFunctions/ClearPermissionsForResource">http://tempuri.org/IAdministrativeFunctions/ClearPermissionsForResource</a>	
<a href="http://tempuri.org/IAdministrativeFunctions/AddActionEntityType">http://tempuri.org/IAdministrativeFunctions/AddActionEntityType</a>	
<a href="http://tempuri.org/IAdministrativeFunctions/AddOperation">http://tempuri.org/IAdministrativeFunctions/AddOperation</a>	

<a href="http://tempuri.org/IAdministrativeFunctions/AddRole">http://tempuri.org/IAdministrativeFunctions/AddRole</a>
<a href="http://tempuri.org/IAdministrativeFunctions/AddTask">http://tempuri.org/IAdministrativeFunctions/AddTask</a>
<a href="http://tempuri.org/IAdministrativeFunctions/AssignOperations">http://tempuri.org/IAdministrativeFunctions/AssignOperations</a>
<a href="http://tempuri.org/IAdministrativeFunctions/AssignRole">http://tempuri.org/IAdministrativeFunctions/AssignRole</a>
<a href="http://tempuri.org/IAdministrativeFunctions/ChangeUserPassword">http://tempuri.org/IAdministrativeFunctions/ChangeUserPassword</a>
<a href="http://tempuri.org/IAdministrativeFunctions/DeassignOperations">http://tempuri.org/IAdministrativeFunctions/DeassignOperations</a>
<a href="http://tempuri.org/IAdministrativeFunctions/DeassignRole">http://tempuri.org/IAdministrativeFunctions/DeassignRole</a>
<a href="http://tempuri.org/IAdministrativeFunctions/DeleteActionEntityType">http://tempuri.org/IAdministrativeFunctions/DeleteActionEntityType</a>
<a href="http://tempuri.org/IAdministrativeFunctions/DeleteOperation">http://tempuri.org/IAdministrativeFunctions/DeleteOperation</a>
<a href="http://tempuri.org/IAdministrativeFunctions/DeletePermissionForResourceAndOperation">http://tempuri.org/IAdministrativeFunctions/DeletePermissionForResourceAndOperation</a>
<a href="http://tempuri.org/IAdministrativeFunctions/DeletePermissionsForResourcesAndOperations">http://tempuri.org/IAdministrativeFunctions/DeletePermissionsForResourcesAndOperations</a>
<a href="http://tempuri.org/IAdministrativeFunctions/DeleteRole">http://tempuri.org/IAdministrativeFunctions/DeleteRole</a>
<a href="http://tempuri.org/IAdministrativeFunctions/DeleteTask">http://tempuri.org/IAdministrativeFunctions/DeleteTask</a>
<a href="http://tempuri.org/IAdministrativeFunctions/GetActionEntityType">http://tempuri.org/IAdministrativeFunctions/GetActionEntityType</a>
<a href="http://tempuri.org/IAdministrativeFunctions/GetAvailableDomains">http://tempuri.org/IAdministrativeFunctions/GetAvailableDomains</a>
<a href="http://tempuri.org/IAdministrativeFunctions/GetCallerIsSuperUser">http://tempuri.org/IAdministrativeFunctions/GetCallerIsSuperUser</a>
<a href="http://tempuri.org/IAdministrativeFunctions/GetConnectedRolesAndOperations">http://tempuri.org/IAdministrativeFunctions/GetConnectedRolesAndOperations</a>
<a href="http://tempuri.org/IAdministrativeFunctions/GetEntityTypes">http://tempuri.org/IAdministrativeFunctions/GetEntityTypes</a>
<a href="http://tempuri.org/IAdministrativeFunctions/GetOperationByName">http://tempuri.org/IAdministrativeFunctions/GetOperationByName</a>
<a href="http://tempuri.org/IAdministrativeFunctions/GetOperationByNameExcludingId">http://tempuri.org/IAdministrativeFunctions/GetOperationByNameExcludingId</a>

Operation Name	Operation Description
<a href="http://tempuri.org/IAdministrativeFunctions/GetOperations">http://tempuri.org/IAdministrativeFunctions/GetOperations</a>	
<a href="http://tempuri.org/IAdministrativeFunctions/GetRoleByNameExcludingId">http://tempuri.org/IAdministrativeFunctions/GetRoleByNameExcludingId</a>	
<a href="http://tempuri.org/IAdministrativeFunctions/GetRoleDefinition">http://tempuri.org/IAdministrativeFunctions/GetRoleDefinition</a>	
<a href="http://tempuri.org/IAdministrativeFunctions/GetRolesDefinitionIntersect">http://tempuri.org/IAdministrativeFunctions/GetRolesDefinitionIntersect</a>	
<a href="http://tempuri.org/IAdministrativeFunctions/GetRoleUsers">http://tempuri.org/IAdministrativeFunctions/GetRoleUsers</a>	
<a href="http://tempuri.org/IAdministrativeFunctions/GetSubscriptions">http://tempuri.org/IAdministrativeFunctions/GetSubscriptions</a>	
<a href="http://tempuri.org/IAdministrativeFunctions/GetTaskByName">http://tempuri.org/IAdministrativeFunctions/GetTaskByName</a>	
<a href="http://tempuri.org/IAdministrativeFunctions/GetTaskByNameExcludingId">http://tempuri.org/IAdministrativeFunctions/GetTaskByNameExcludingId</a>	
<a href="http://tempuri.org/IAdministrativeFunctions/GetTaskDefinition">http://tempuri.org/IAdministrativeFunctions/GetTaskDefinition</a>	
<a href="http://tempuri.org/IAdministrativeFunctions/GetTasks">http://tempuri.org/IAdministrativeFunctions/GetTasks</a>	

http://tempuri.org/IAdministrativeFunctions/GetUserBySid	
http://tempuri.org/IAdministrativeFunctions/GetUserByUsername	
http://tempuri.org/IAdministrativeFunctions/GetUserDefinedRoles	
http://tempuri.org/IAdministrativeFunctions/GetUserGroupId	
http://tempuri.org/IAdministrativeFunctions/GetUserRoles	
http://tempuri.org/IAdministrativeFunctions/InsertPermissionForResourceAndOperation	
http://tempuri.org/IAdministrativeFunctions/InsertPermissionsForResourcesAndOperations	
http://tempuri.org/IAdministrativeFunctions/InsertResource	
http://tempuri.org/IAdministrativeFunctions/IsChild	
http://tempuri.org/IAdministrativeFunctions/RefreshCache	
http://tempuri.org/IAdministrativeFunctions/SearchUsers	
http://tempuri.org/IAdministrativeFunctions/SetCurrentDomain	
http://tempuri.org/IAdministrativeFunctions/SynchronizeAllSubscribers	
http://tempuri.org/IAdministrativeFunctions/UpdateOperation	
http://tempuri.org/IAdministrativeFunctions/UpdateRole	
http://tempuri.org/IAdministrativeFunctions/UpdateTask	
Patient, Admission Read	'Edit' link from the Home page, Patients Pending Placement list.
Patient, Select Read	'Add New Patient' link from the Home page, Patients Pending Placement section.
Patient, Admission Update	'Submit' button from ADD/EDIT Patients Pending Placement page.

Operation Name	Operation Description
rep, Active Admission Orders Report	Access the Active Admission Orders Report.
rep, Active Discharge Orders Report	Access the Active Discharge Orders Report.
rep, Active Transfer Orders Report	Access the Active Transfer Orders Report.
rep, Antic Discharge Orders Report	Access the Antic Discharge Orders Report.
rep, BED AVAILABILITY STATUS REPORT	Access the BED AVAILABILITY STATUS REPORT.
rep, Bed Specialty Report	Access the Bed Specialty Report.
rep, Bed Specialty Roster	Access the Bed Specialty Roster.
rep, Bed Summary Report	Access the Bed Summary Report.
rep, Bed Turnaround Time Report	Access the Bed Turnaround Time Report.
rep, Beds Out of Service Report (All)	Access the Beds Out of Service Report (All).
rep, Beds Out of Service Report (By Date)	Access the Beds Out of Service Report (By Date).
rep, Discharges In Progress	Access the Discharges In Progress.

rep, Emergency Management Evacuation Report	Access Emergency Management Evacuation Report
rep, Icon Usage Report	Access the Icon Usage Report
rep, Patient Inquiry	Access the Patient Inquiry report.
rep, Patient Movement Report	Access the Patient Movement Report.
rep, Patient Movements by Date	Access the Patient Movements by Date.
rep, Patients w Discharge Appointments	Access the Patients w Discharge Appointments.
rep, Scheduled Admissions by Date	Access the Scheduled Admissions by Date.
rep, Scheduled Admissions Report	Access the Scheduled Admissions Report.
rep, VISN Bed Summary Report	Access VISN Bed Summary Report
rep, VISN Network Active Report	Access the VISN Network Active Report.
rep, VISN Network Audit Report	Access the VISN Network Audit Report.
rep, VISN Network Contract Report	Access the VISN Network Contract Report.
rep, VISN Network Disposition Report	Access the VISN Network Disposition Report.
rep, Wait List Status Report	Access the Patients Pending Placement Status Report.
Reports, Index Read	'Submit' buttons from the Home page corresponding to the reports.
SiteOptions, Index Read	Home page, Site Options link.
SiteOptions, EvacuationConfirmation Read	Access to Evacuation Confirmation page.
SiteOptions, Index Update	'Submit' button from Site Options page.
SiteOptions, EvacuationConfirmation Update	'Save' button from Evacuation Confirmation page.
Transfer, AddTransfer Read	VISN page, Add New Patient button, Submit button from the Select Patient page.
Transfer, EditTransfer Read	'Edit' link from the VISN page, Patients in Community

Operation Name	Operation Description
	Hospitals list.
Transfer, FinalizeTransfer Read	'Finalize' link from the VISN page, Patients in Community Hospitals list.
Transfer, Index Read	VISN page, Add New Patient button.
Transfer, AddTransfer Update	VISN page, Add New Patient button, Submit button from the Select Patient page, and Submit button from the Enter Patient Data page.
Transfer, EditTransfer Update	'Edit' link from the VISN page's Patients in Community Hospitals list and then Submit button.
Transfer, FinalizeTransfer Update	'Finalize' link from the VISN page's Patients in Community Hospitals list and then Submit button from the Finalize Patient Data page.
UnavailableReason, Delete Read	'Delete' link from the Bed Board Site Unavailable Reason page's list.
UnavailableReason, Edit Read	'Edit' link from the Bed Board Site Unavailable Reason page's list.
UnavailableReason, Index Read	Site Options, Unavailable Reason Add/Edit link.
UnavailableReason, Delete Update	'Delete' link from the Bed Board Site Unavailable Reason page's list and then 'Delete Record' button.

UnavailableReason, Edit Update	'Edit' link from the Bed Board Site Unavailable Reason page's list and then Submit button.
UnavailableReason, Index Update	'Add' button from the Bed Board Site Unavailable Reason page.
UserConfiguration, Index Read	Site Options, Add/Edit BMS User link.
UserConfiguration, SearchUser Read	'Find and Save' buttons from the 'Select user' page ('Select Existing NT User Name' button from the Site Options, 'Add/Edit BMS User' link ).
UserConfiguration, SelectUser Read	'Select Existing NT User Name' button from the Site Options - Add/Edit BMS User page.
UserConfiguration, Index Update	'Submit' button from the Site Options - Add/Edit BMS User page.
VistaIntegration, Audit Read	'Audit' tab on ADMINISTRATION SECTION - Background Processors page (Background Processors Submenu) and 'Filter By' button from the 'Audit' tab.
VistaIntegration, Categories Read	'VistA Integration' tab on ADMINISTRATION SECTION - Background Processors page (Background Processors Submenu).
VistaIntegration, DeleteScheduler Read	'Add new scheduler' link and select a scheduled name from the 'Scheduled' tab.
VistaIntegration, Index Read	'Background Processors' link on ADMINISTRATION SECTION.
VistaIntegration, Schedulers Read	'Schedulers' tab on ADMINISTRATION SECTION - Background Processors page (Background Processors Submenu).
VistaIntegration, TestMDWConnection Read	'TestMDWConnection' button from the 'VistA Sites' tab.
VistaIntegration, TestODBCConnection Read	'TestODBCConnection' button from the 'VistA Sites' tab.
VistaIntegration, VistASites Read	'VistA Sites' tab on ADMINISTRATION SECTION - Background Processors page (Background Processors Submenu).
VistaIntegration, Categories Update	'Save and Run' buttons from the 'VistA Integration' tab.
VistaIntegration, DeleteScheduler Update	'Delete' link from the 'Scheduled' tab and then 'Delete Record' button.

Operation Name	Operation Description
VistaIntegration, Schedulers Update	'Save' button from the 'Scheduled' tab.
VistaIntegration, VistASites Update	'Save' button from the 'VistA Sites' tab.
WaitingArea, Delete Read	'Delete' link from the Patient Waiting Areas page's list of Current Waiting Areas.
WaitingArea, Edit Read	'Edit' link from the Patient Waiting Areas page's list of Current Waiting Areas.
WaitingArea, Index Read	Site Options, Waiting Area Add/Delete link.
WaitingArea, DeleteAction Update	'Delete' link from the Patient Waiting Areas page's list of Current Waiting Areas and then 'Delete Record' button.
WaitingArea, Edit Update	'Edit' link from the Patient Waiting Areas page's list of Current Waiting Areas and then Submit button.
WaitingArea, Index Update	'Add' button from the Patient Waiting Areas page.
WardConfiguration, Delete Read	'Delete' link from the Bed Board Ward Configuration, Current Vista Wards list.
WardConfiguration, Index Read	Site Options, Vista Ward Add/Edit link.
WardConfiguration, Index Update	Site Options, Vista Ward Add/Edit link, Save button.
WardConfiguration, DeleteWard Update	Site Options, Vista Ward Add/Edit link, Delete operation.





Figure 64 - Task Definition

To determine what resource type the task refers to, select one or more of the elements in the “Applies to resource types” area.

To view the operations that need to be performed in order to complete the task, select the Definition tab to display it as in the following image:

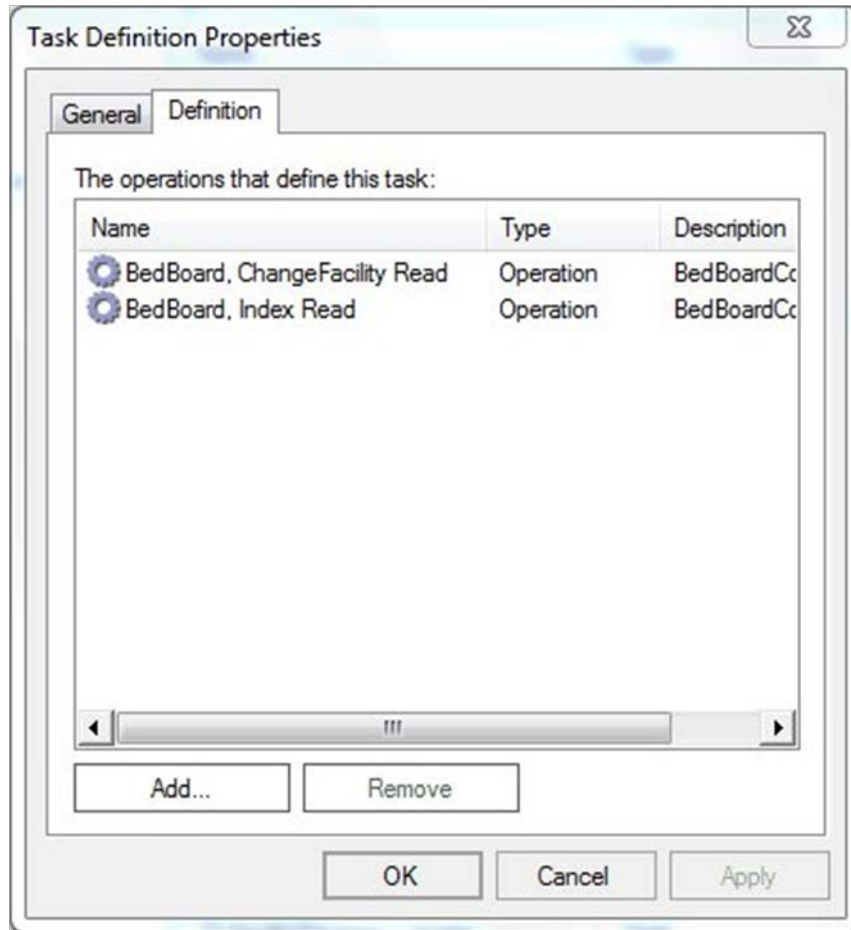

Figure 65 - Operations Defining a Task

Use the Add and Remove buttons to add or remove operations from the list.

A list with all the tasks, along with corresponding operations of the BMS application, is presented below:

T  
a  
b  
l  
e  
  
2  
8  
  
-

B  
M  
S  
  
T  
a  
s  
k  
s

Task Name	Task Description	Operation Name
Admin, Read	Admin Read permission, user has the right only to view data.	Admin, AddEditUser
		Admin, FacilityEdit R
		Admin, Index Read
		Admin, SelectUser R
		Admin, SisterSiteAdo
		Admin, AddUserOpe
		Admin, RemoveUser
		Admin, SearchUser F
		Admin, SearchUsers
Admin, ClearCache f		
Admin, Update	Admin Update permission, user has the right to modify data.	Admin, AddEditUser
		Admin, FacilityEdit U
		Admin, SisterSiteAdo
		Admin, AddUserOpe
AdminComments, Read	AdminComments Read Read permission, user has the right only to view data.	AdminComments, De
		AdminComments, Ec
AdminComments, Update	AdminComments Update permission, user has the right to modify data.	AdminComments, Ine
		AdminComments, Ine
AdminIcon, Read	AdminIcon Read permission, user has the right only to view data.	AdminIcon, Delete R
		AdminIcon, Edit Rea
		AdminIcon, Index Re
		AdminIcon, Search F
AdminIcon, Update	AdminIcon Update permission, user has the right to modify data.	AdminIcon, ViewIcon
		AdminIcon, Delete U
		AdminIcon, Edit Upd

Task Name	Task Description	Operation Name
		AdminIcon, Index Up
AdminSpecialtyAssociation, Read	AdminSpecialtyAssociation Read permission, user has the right only to view data.	AdminSpecialtyAssoc
		AdminSpecialtyAssoc
AdminSpecialtyAssociation, Update	AdminSpecialtyAssociation Update permission, user has the right to modify data.	AdminSpecialtyAssoc
		AdminSpecialtyAssoc

AdminUnavailableReason, Read	AdminUnavailableReason Read permission, user has the right only to view data.	AdminUnavailableReason, Read
AdminUnavailableReason, Update	AdminUnavailableReason Update permission, user has the right to modify data.	AdminUnavailableReason, Update
AdminWaitingArea, Read	AdminWaitingArea Read permission, user has the right only to view data.	AdminWaitingArea, Read
AdminWaitingArea, Update	AdminWaitingArea Update permission, user has the right to modify data.	AdminWaitingArea, Update
AdminWhiteboardReport, Read	AdminWhiteboardReport Read permission, user has the right only to view data.	AdminWhiteboardReport, Read
AdminWhiteboardReport, Update	AdminWhiteboardReport Update permission, user has the right to modify data.	AdminWhiteboardReport, Update
AdtOrderableItems, Read	AdtOrderableItems Read permission, user has the right only to view data.	AdtOrderableItems, Read
AdtOrderableItems, Update	AdtOrderableItems Update permission, user has the right to modify data.	AdtOrderableItems, Update
BackgroundProcessors, Read	BackgroundProcessors Read permission, user has the right only to view data.	BackgroundProcessors, Read
BackgroundProcessors, Update	BackgroundProcessors Update permission, user has the right to modify data.	BackgroundProcessors, Update
AuditLogReport, Read	AuditLogReport Read permission, user has the right	AuditLogReport, Read

Task Name	Task Description	Operation Name
	only to view data.	rep, Audit Log Report
BedBoard, Read	BedBoard Read permission, user has the right only to view data.	BedBoard, ChangeF BedBoard, Index Rea BedBoard, ShowFac BedBoard, ShowVIS
BedBoardModule, Read	BedBoardModule Read permission, user has the right only to view data.	BedBoardModule, In
BedBoardModule, Update	BedBoardModule Update permission, user has the right to modify data.	BedBoardModule, In
BedInformation, Read	BedInformation Read permission, user has the right only to view data.	BedInformation, Inde BedInformation, Clea BedInformation, Noti
BedInformation, Update	BedInformation Update permission, user has the right to modify data.	BedInformation, Inde
ContingencySettings, Read	ContingencySettings Read permission, user has the right only to view data.	ContingencySettings
ContingencySettings, Update	ContingencySettings Update permission, user has the right to modify data.	ContingencySettings

DischargeClinic, Read	DischargeClinic Read permission, user has the right only to view data.	DischargeClinic, Inde
DischargeClinic, Update	DischargeClinic Update permission, user has the right to modify data.	DischargeClinic, Dele DischargeClinic, Inde
EmsBedStatusAdmin, EMS Supervisor	EmsBedStatusAdmin EMS Supervisor permission, user has the right to re-assign the bed cleaning to another person and to batch assign the cleaning to a person.	EmsBedStatusAdmin EmsBedStatusAdmin EmsBedStatusAdmin
EmsBedStatusAdmin, Read	EmsBedStatusAdmin Read permission, user has the right only to view data.	EmsBedStatusAdmin EmsBedStatusAdmin EmsBedStatusAdmin
EmsBedStatusAdmin, Update	EmsBedStatusAdmin Update permission, user has the right to modify data.	EmsBedStatusAdmin
EMSMobile, Read	EMSMobile Read permission, user has the right only to	EMSMobile, EMSList

Task Name	Task Description	Operation Name
	view data.	EMSMobile, Users R
EMSMobile, Update	EMSMobile Update permission, user has the right to modify data.	EMSMobile, EMSList EMSMobile, Users U
EmsNotification, Read	EmsNotification Read permission, user has the right only to view data.	EmsNotification, Add EmsNotification, Add EmsNotification, Dele EmsNotification, Inde
EmsNotification, Update	EmsNotification Update permission, user has the right to modify data.	EmsNotification, Dele EmsNotification, Inde
EmsStaff, Read	EmsStaff Read permission, user has the right only to view data.	EmsStaff, Delete Rea EmsStaff, Edit Read EmsStaff, Index Rea
EmsStaff, Update	EmsStaff Update permission, user has the right to modify data.	EmsStaff, Delete Upd EmsStaff, Edit Updat
EventNotification, Read	EventNotification Read permission, user has the right only to view data.	EventNotification, Ad EventNotification, Ad EventNotification, Ed EventNotification, Inc
EventNotification, Update	EventNotification Update permission, user has the right to modify data.	EventNotification, Inc
Exception, Read	Exception Read permission, user has the right only to view data.	Exception, Index Rea
FacilityDiversion, Read	FacilityDiversion Read permission, user has the right only to view data.	FacilityDiversion, Ad FacilityDiversion, Ad FacilityDiversion, Edi FacilityDiversion, Edi FacilityDiversion, Filtr FacilityDiversion, Ind

FacilityDiversion, Update	FacilityDiversion Update permission, user has the right to modify data.	FacilityDiversion, Ind
---------------------------	---	------------------------

Task Name	Task Description	Operation Name
FacilitySettings, Read	FacilitySettings Read permission, user has the right only to view data.	FacilitySettings, Inde
FacilitySettings, Update	FacilitySettings Update permission, user has the right to modify data.	FacilitySettings, Inde
Home, Read	Home Read permission, user has the right only to view data.	Home, Index Read
		Home, Index2 Read
		Home, PatientInquiry
		Home, RemoveAdmi
		Home, UndoRemove
Home, Update	Home Update permission, user has the right to modify data.	Home, RemoveAdmi
		Home, UndoRemove
IconLegend, Read	IconLegend Read permission, user has the right only to view data.	IconLegend, Index R
IconLibrary, Read	IconLibrary Read permission, user has the right only to view data.	IconLibrary, Edit Rea
		IconLibrary, Index Re
		IconLibrary, ResetCo
IconLibrary, Update	IconLibrary Update permission, user has the right to modify data.	IconLibrary, Edit Upd
		IconLibrary, Index Up
		IconLibrary, ResetCo
Information, Read	Information Read permission, user has the right only to view data.	Information, Index Re
MaintainMarquee, Read	MaintainMarquee Read permission, user has the right only to view data.	MaintainMarquee, In
MaintainMarquee, Update	MaintainMarquee Update permission, user has the right to modify data.	MaintainMarquee, Ch
NationalAndRegional, Read	NationalAndRegional Read permission, user has the right only to view data.	NationalAndRegiona
NewEvents, Read	NewEvents Read permission, user has the right only to view data.	NewEvents, Index Re
Numi, Read	NUMI Read permission, user has the right only to view data.	Numi, Add Read
		Numi, Delete Read

Task Name	Task Description	Operation Name
		Numi, Edit Read
		Numi, Index Read
Numi, Update	NUMI Update permission, user has the right to modify data.	Numi, Delete Update
		Numi, Edit Update
		<a href="http://tempuri.org/IAc">http://tempuri.org/IAc</a>
		<a href="http://tempuri.org/IAc">http://tempuri.org/IAc</a> omain

PAP, User	PAP permission, the right to access methods exposed by PAP service.
-----------	---

http://tempuri.org/IAc
http://tempuri.org/IAc
ies
http://tempuri.org/IAc
sion
http://tempuri.org/IAc
ission
http://tempuri.org/IAc
ame
http://tempuri.org/IAc
onsByResourceType
http://tempuri.org/IAc
AndDomain
http://tempuri.org/IAc
oles
http://tempuri.org/IAc
er
http://tempuri.org/IAc
sionsForResource
http://tempuri.org/IAc
tityType
http://tempuri.org/IAc
n
http://tempuri.org/IAc
http://tempuri.org/IAc
http://tempuri.org/IAc
tions
http://tempuri.org/IAc
http://tempuri.org/IAc

Task Name	Task Description

Operation Name
Password
http://tempuri.org/IAc
erations
http://tempuri.org/IAc
e
http://tempuri.org/IAc
EntityType
http://tempuri.org/IAc
tion
http://tempuri.org/IAc
ssionForResourceAn
http://tempuri.org/IAc
ssionsForResource
http://tempuri.org/IAc
http://tempuri.org/IAc
http://tempuri.org/IAc
tityTypes
http://tempuri.org/IAc
Domains
http://tempuri.org/IAc
uperUser
http://tempuri.org/IAc
edRolesAndOperatio
http://tempuri.org/IAc
es



Reporting Services, Fetch	Reporting Services Fetch permission, the right to bring	rep, Active Admissions
---------------------------	---	------------------------

Task Name	Task Description	Operation Name
	the list of reports from Reporting Services.	rep, Active Discharge rep, Active Transfer rep, Antic Discharge rep, BED AVAILABIL rep, Bed Specialty R rep, Bed Specialty R rep, Bed Summary R rep, Bed Turnaround rep, Beds Out of Ser rep, Beds Out of Ser rep, Discharges In P rep, Emergency Man rep, Icon Usage Rep rep, Patient Inquiry rep, Patient Moveme rep, Patient Moveme rep, Patients w Disch rep, Scheduled Admi rep, Scheduled Admi rep, VISN Bed Summ rep, VISN Network A rep, VISN Network A rep, VISN Network C rep, VISN Network D rep, Wait List Status
Reports, Read	Reports permission, user has the right only to view data.	Reports, Index Read
SiteOptions, Read	SiteOptions permission, user has the right only to view data.	SiteOptions, Index R SiteOptions, Evacuat
SiteOptions, Update	SiteOptions Update permission, user has the right to	SiteOptions, Index U

Task Name	Task Description	Operation Name
	modify data.	SiteOptions, Evacuat
Transfer, Read	Transfer permission, user has the right only to view data.	Transfer, AddTransfe Transfer, EditTransfe Transfer, FinalizeTra Transfer, Index Reac
Transfer, Update	Transfer Update permission, user has the right to modify data.	Transfer, AddTransfe Transfer, EditTransfe Transfer, FinalizeTra



UnavailableReason, Read	UnavailableReason Read permission, user has the right only to view data.	UnavailableReason, UnavailableReason, UnavailableReason,
UnavailableReason, Update	UnavailableReason Update permission, user has the right to modify data.	UnavailableReason, UnavailableReason, UnavailableReason,
UserConfiguration, Read	UserConfiguration permission, user has the right only to view data.	UserConfiguration, Ir UserConfiguration, S UserConfiguration, S
UserConfiguration, Update	UserConfiguration Update permission, user has the right to modify data.	UserConfiguration, Ir
VistaIntegration, Read	VistaIntegration permission, user has the right only to view data.	VistaIntegration, Aud VistaIntegration, Cate VistaIntegration, Dele VistaIntegration, Inde VistaIntegration, Sch VistaIntegration, Tes VistaIntegration, Tes VistaIntegration, Vist
VistaIntegration, Update	VistaIntegration Update permission, user has the right to modify data.	VistaIntegration, Cate VistaIntegration, Dele VistaIntegration, Sch

Task Name	Task Description	Operation Name
		VistaIntegration, Vist
WaitingArea, Read	WaitingArea permission, user has the right only to view data.	WaitingArea, Delete WaitingArea, Edit Re WaitingArea, Index R
WaitingArea, Update	WaitingArea Update permission, user has the right to modify data.	WaitingArea, Delete/ WaitingArea, Edit Up WaitingArea, Index U
WardConfiguration, Read	WardConfiguration permission, user has the right only to view data.	WardConfiguration, D WardConfiguration, I
WardConfiguration, Update	WardConfiguration Update permission, user has the right to modify data.	WardConfiguration, I WardConfiguration, D
WardOccupancy, Read	WardOccupancy permission, user has the right only to view data.	WardOccupancy, Inc
WardWhiteboard, Read	WardWhiteboard permission, user has the right only to view data.	WardWhiteboard, Ed WardWhiteboard, Ed WardWhiteboard, Inc WardWhiteboard, No WhiteboardStaff, Ind WardWhiteboard, Sh

		WardWhiteboard, Su
		WardWhiteBoard, W
		WardWhiteboard, Cle
WardWhiteboard, Update	WardWhiteboard Update permission, user has the right to modify data.	WardWhiteBoard, W
		WhiteboardStaff, Ind
		WardWhiteboard, Ed

## 7.4 Role Definitions

To view the actual definition of a BMS user role, from the Definitions folder select Role Definitions and double click the role name in the main panel of Policy Manager: in the Role Definition Properties dialog window, select the Definition tab to display it as in the following image:

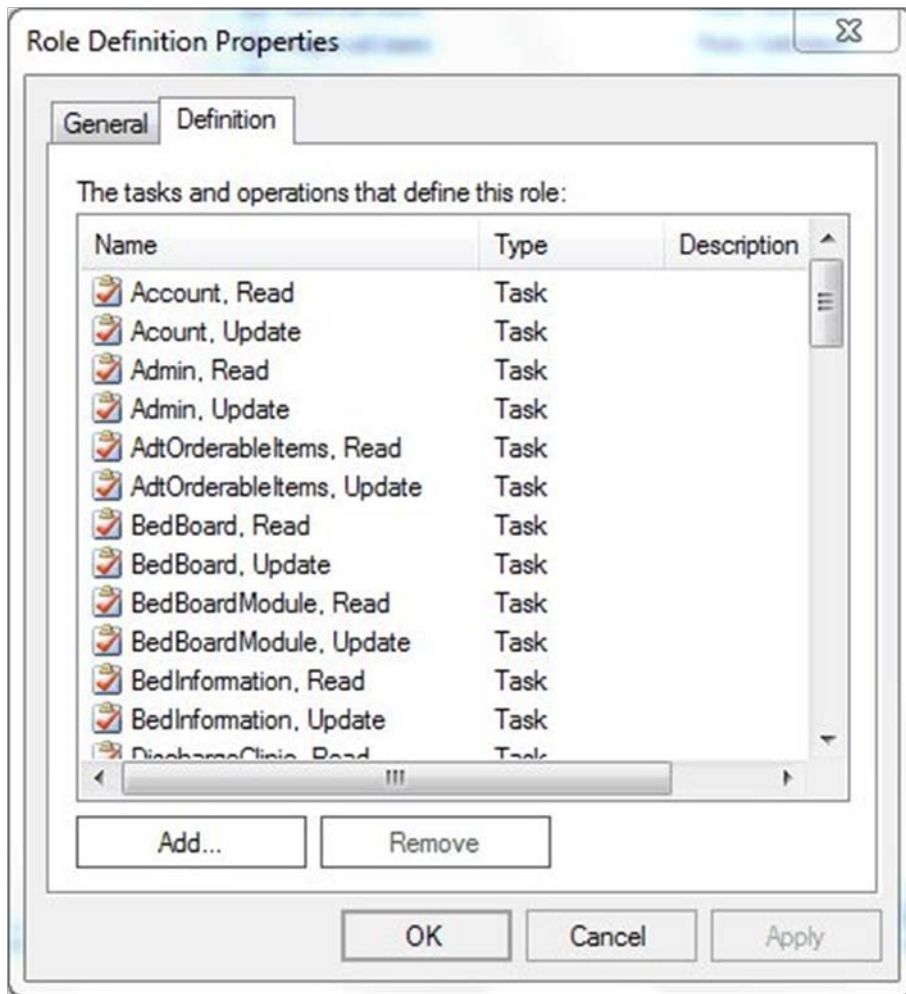

Figure 66 - Role Definition

## 7.5 Assigning a Role to a User

To assign one of the roles defined for BMS to a user follow the steps below.

From the main page of Policy Manager, from Role assignments folder select a role then right-click and select “Assign Windows Users and Groups”: the following dialog is displayed.

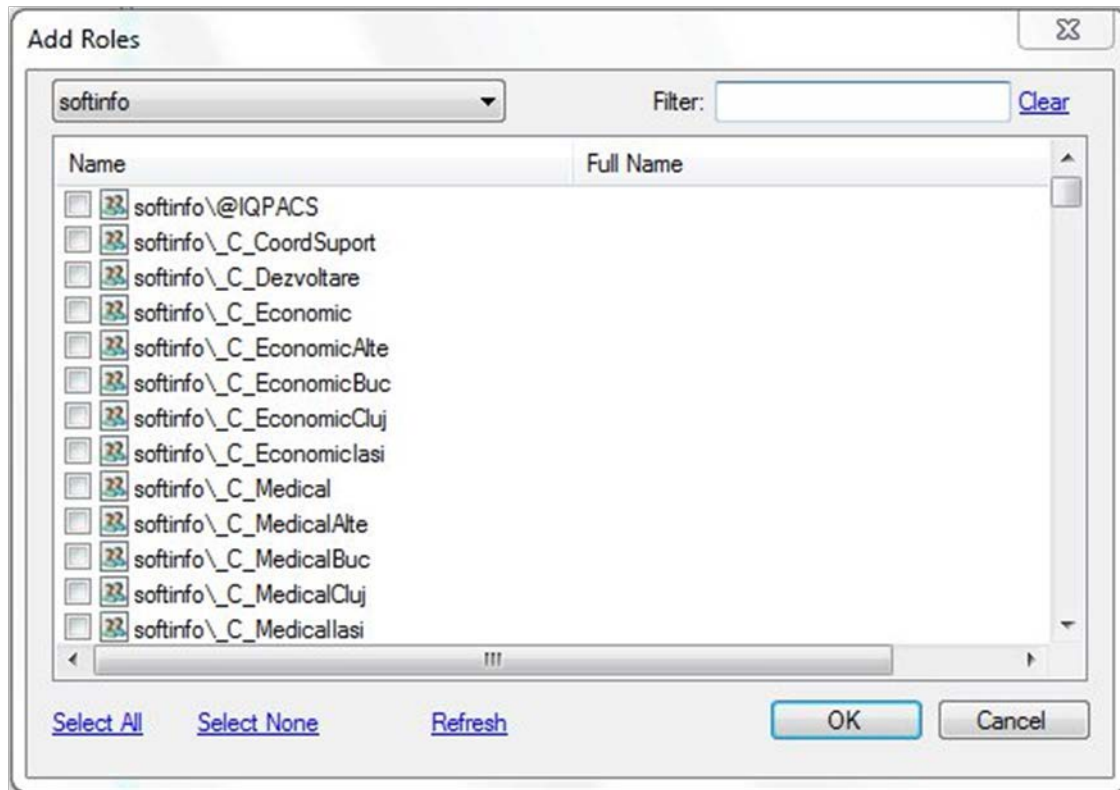

Figure 67 - Assigning Roles to Users

A list of users and user groups existing in the current domain are displayed. Use the arrow button of the field in the upper left corner of the dialog to select the domain and the Filter field if necessary, and then click each applicable check box to select the user or group of users for which you want to assign the selected BMS role. Click OK to finalize the operation.

## 7.6 Adding a New Role

To add a new role, click the Add Role button from the main Policy Manager window or right-click Role Definitions folder and select New Role Definition...: the following dialog window is displayed:

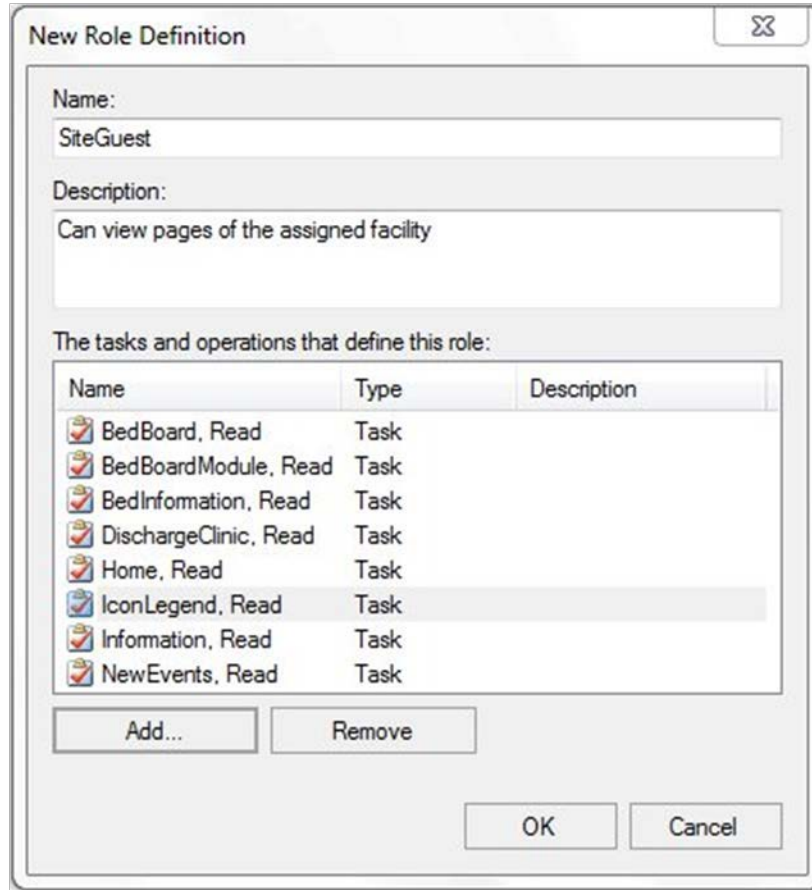
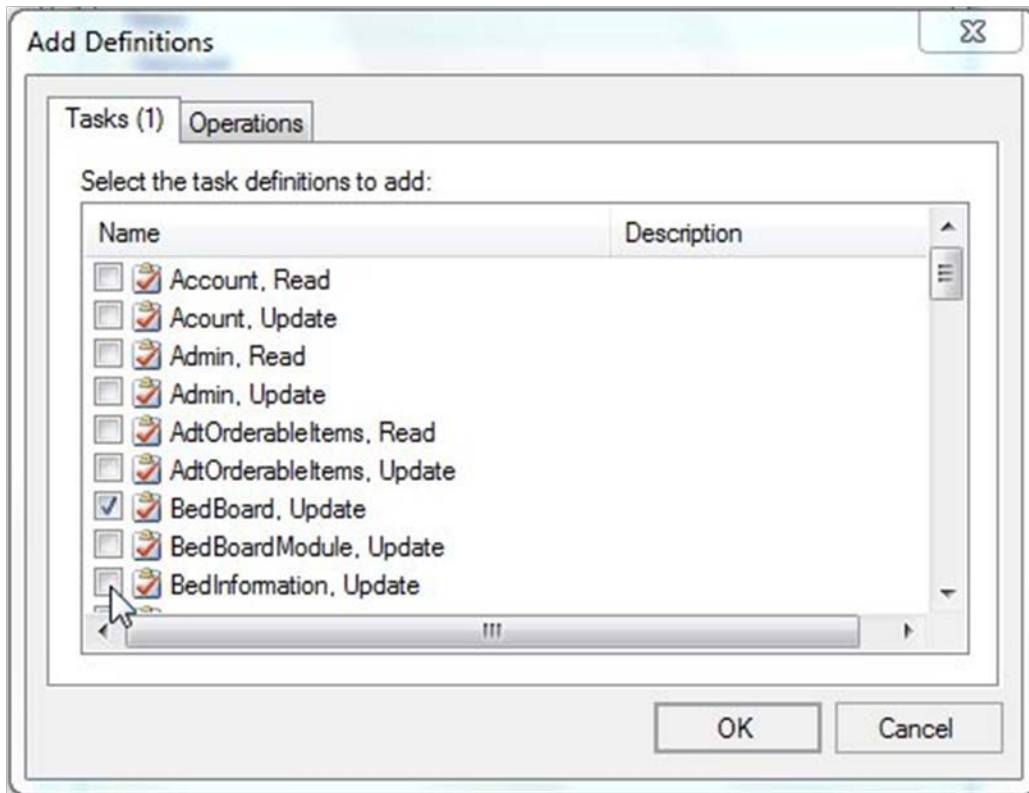

Figure 68 - New Role Definition

Enter the name of the new role and a short description.

To add the tasks and operations that can be performed for this role click the Add button to display the following dialog window:



*Figure 69 - Adding Tasks and Operations to a Role*

Tasks and operations that can be performed within the BMS system are available in separate tabs. Select the ones to be included in the definition of the current role (the number of selected tasks/operations will be displayed in the corresponding tab title) then press OK:

The selected tasks and operations will be displayed in the New Role Definition dialog box. Press OK to add the role to the list of roles defined for BMS: The Roles Definitions list will be updated to contain the new role. To add the new role to the Role Assignment folder, select the folder, right-click and select Assign Roles to display the following dialog window:

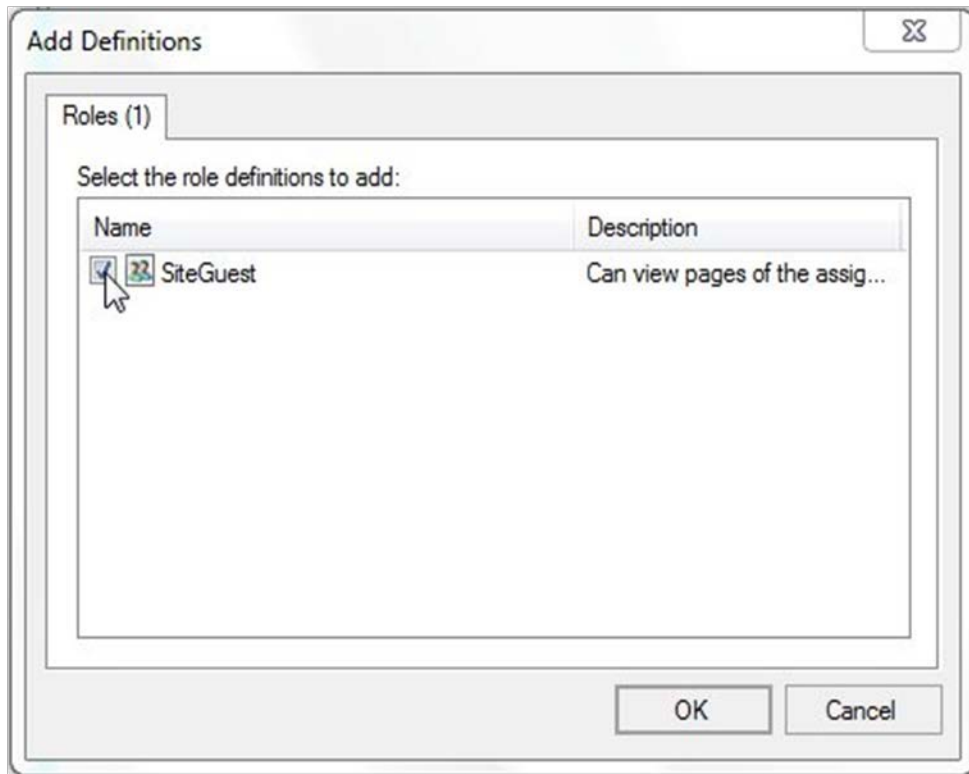
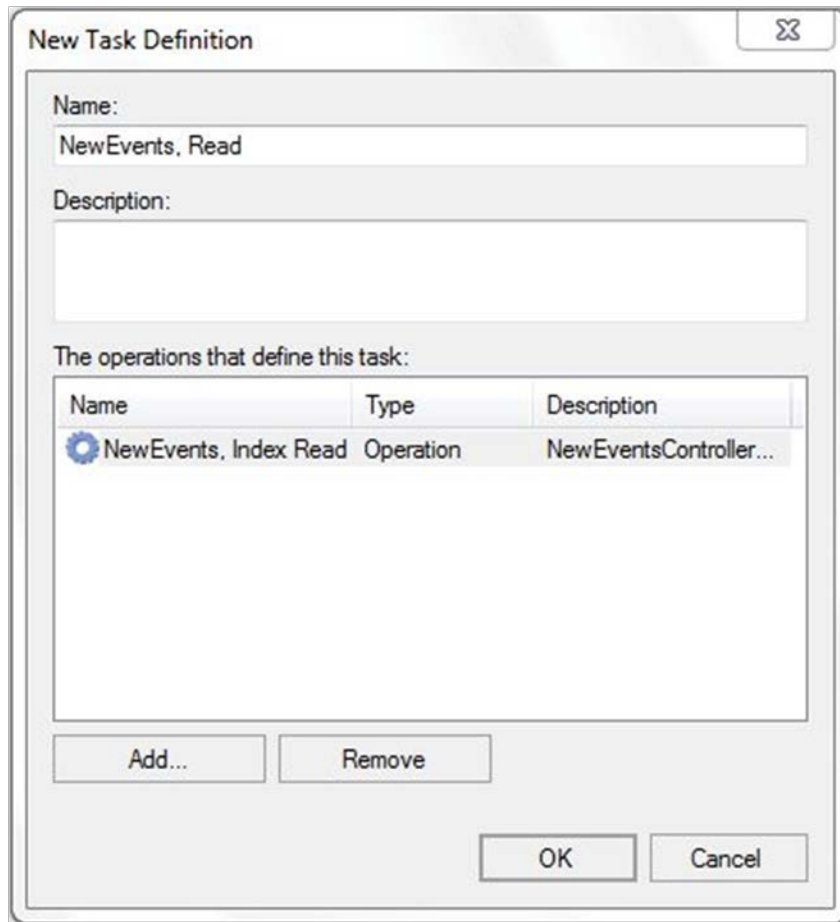

*Figure 70 - Add Role to Role Assignments List*

Select the role then press OK: The newly added role will be displayed in the Role Assignments list and you will be able to assign the new role to BMS users.

## **7.7 Adding a New Task**

To add a new task, click the Add Task button from the main Policy Manager window or right-click Task Definitions folder and select New Task Definition: The following dialog window is displayed:



*Figure 71 - New Task Definition*

Enter the name of the new task followed by read/write option and a short description.  
To add the operations that define the Task, click the Add button to display the following dialog window:

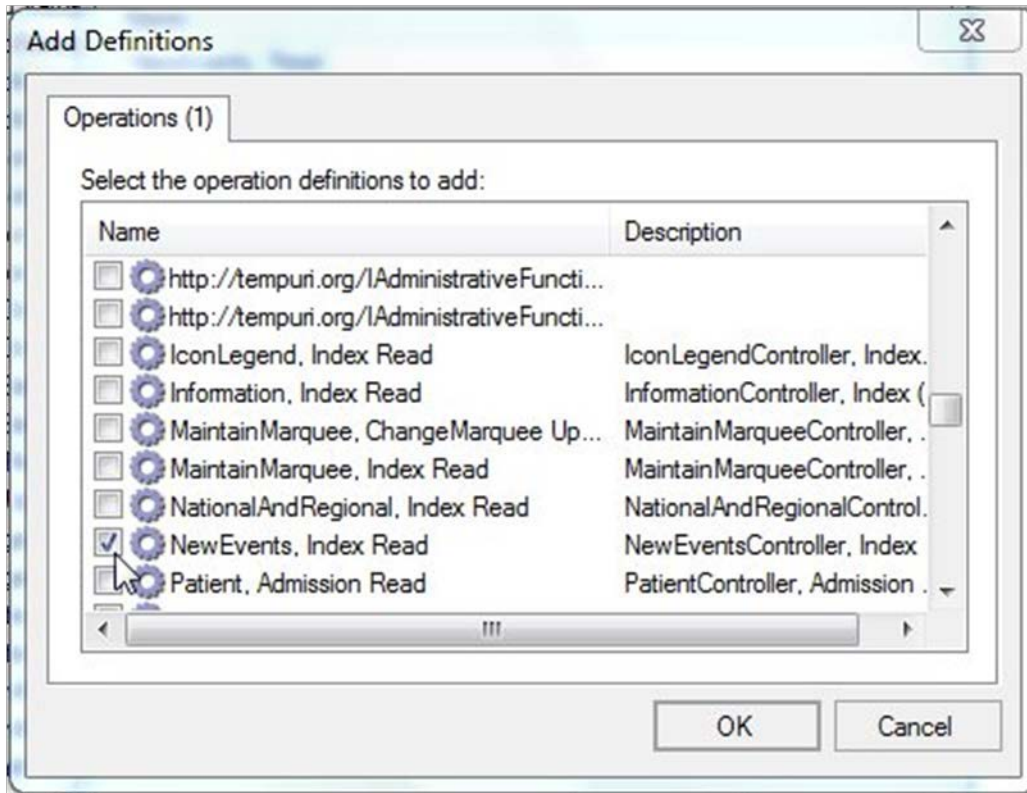
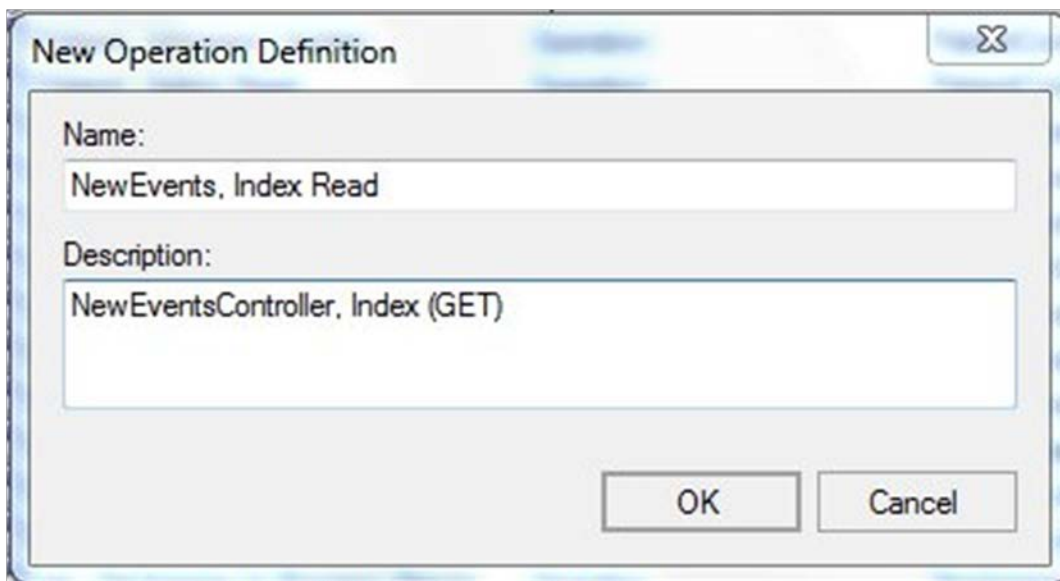

Figure 72 - Adding Operations to a Task

Select the operations that define the selected task then click OK to return to the New Task Definition dialog box. Click OK to add the new task to the Task Definitions list.

## 7.8 Adding a New Operation

To add a new operation, click the Add Operation button from the main Policy Manager window or right-click Operation Definitions folder and select New Operation Definition: The following dialog window is displayed.



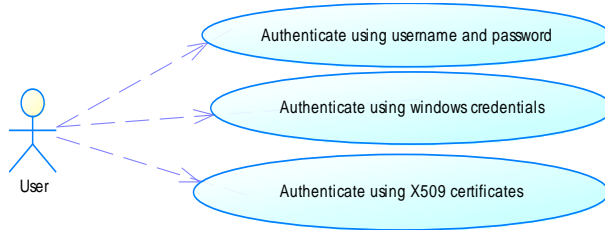

**Figure 48 - New Operation Definition**

Enter the name of the new operation followed by read/write option and a short description. Click OK to add the new operation to the Operation Definitions list.

## 7.9 Business scenarios and use cases

### Authentication



**Figure 49– Authentication use cases**

<i>Section</i>	<i>Description</i>
<b>Use Case Name</b>	User authentication
<b>Summary</b>	In the above diagram it is represented the methods that a client application can use to authenticate their users.
<b>Preconditions</b>	The users, that will use the client application, need to be defined in an Active Directory
<b>Triggers</b>	External
<b>Basic course of events</b>	<ol style="list-style-type: none"> <li>1. The client application will send the user and the password or windows credentials</li> <li>2. The system verifies the login information.</li> <li>3. The system returns the result of the verification to the client application.</li> </ol>
<b>Alternative paths</b>	<ol style="list-style-type: none"> <li>1. The client application will send the X509 certificate of his user</li> <li>2. The system verifies the certificate</li> <li>3. The system return the result</li> </ol>

### Authorization

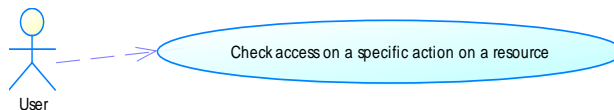

**Figure 50 – Authorization use cases**

<b>Section</b>	<b>Description</b>
<b>Use Case Name</b>	User authorization
<b>Summary</b>	In the above diagram it is represented the methods that a client application can use to check if an authenticated user has access to a specified action on a resource.
<b>Preconditions</b>	The users, actions and resources must be defined in an Active Directory structure that the Security Service is using.
<b>Triggers</b>	External
<b>Basic course of events</b>	<ol style="list-style-type: none"> <li>1. The client application will invoke a check access method for a specified action on a specific resource</li> <li>2. The system will find the actions that the requesting users has access</li> <li>3. The system returns true/false if the action requested is among the users defined actions</li> </ol>

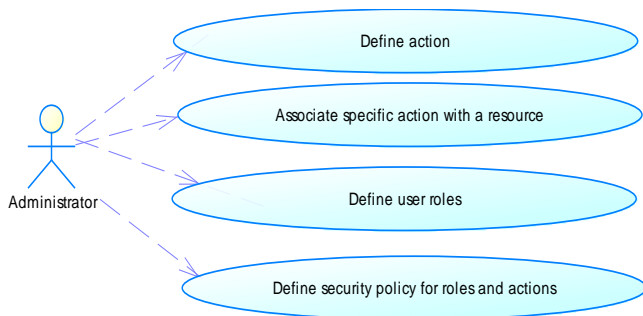

Figure 51 – Authorization administration use cases

<b>Section</b>	<b>Description</b>
<b>Use Case Name</b>	Action and resource management
<b>Summary</b>	Administrative console can define actions and resources and associate an action with a resource type.
<b>Preconditions</b>	The association method mandates that the action and the resource type should already be defined
<b>Triggers</b>	External
<b>Basic course of events</b>	<ol style="list-style-type: none"> <li>1. The client application will invoke a create action</li> <li>2. The system will try to create requested action.</li> <li>3. The system will fail if the specified action name already exists, or specified id already exists.</li> </ol>

<b>Section</b>	<b>Description</b>
<b>Use Case Name</b>	Role management
<b>Summary</b>	Administrative console can define user roles and associate users/user groups with roles.
<b>Preconditions</b>	The association method mandates that the role should already be defined
<b>Triggers</b>	External
<b>Basic course of events</b>	<ol style="list-style-type: none"> <li>1. The client application will invoke a create role</li> <li>2. The system will try to create requested role.</li> <li>3. The system will fail if the specified role name already exists, or specified id already exists.</li> </ol>

<b>Section</b>	<b>Description</b>
<b>Use Case Name</b>	Security policy management
<b>Summary</b>	Administrative console can associate users (groups of users) with roles. These roles are then associated with an action (operation).
<b>Preconditions</b>	The association method mandates that the action and the resource type should already be defined.
<b>Triggers</b>	External

## 8 CA SiteMinder Web Agent (SSO) Installation

1. Locate Webagent install binary “smwa-12.51-cr08-win64-64.exe”
2. Right click on the exe and run as administrator
3. Click yes on the user account control window

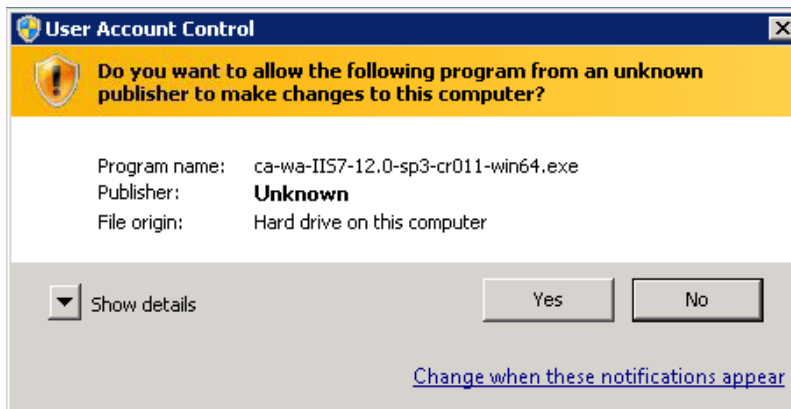

4. Click next

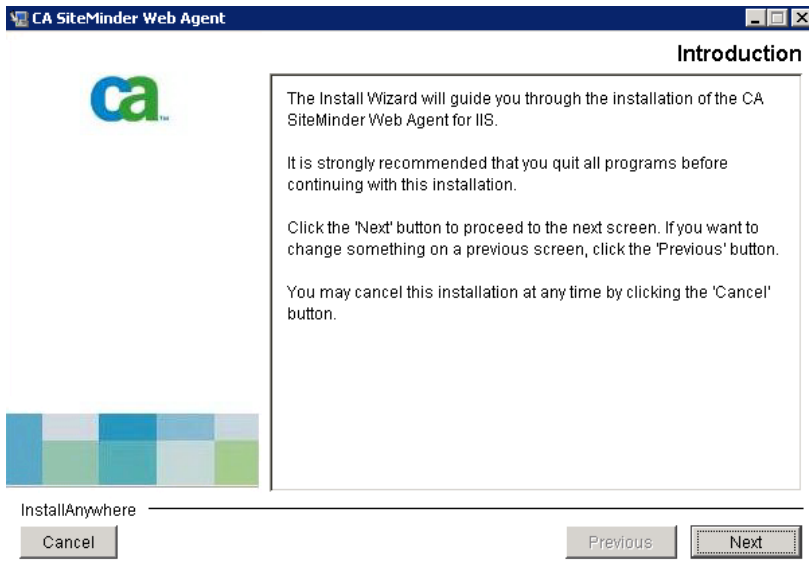

5. Accept License agreement and click next

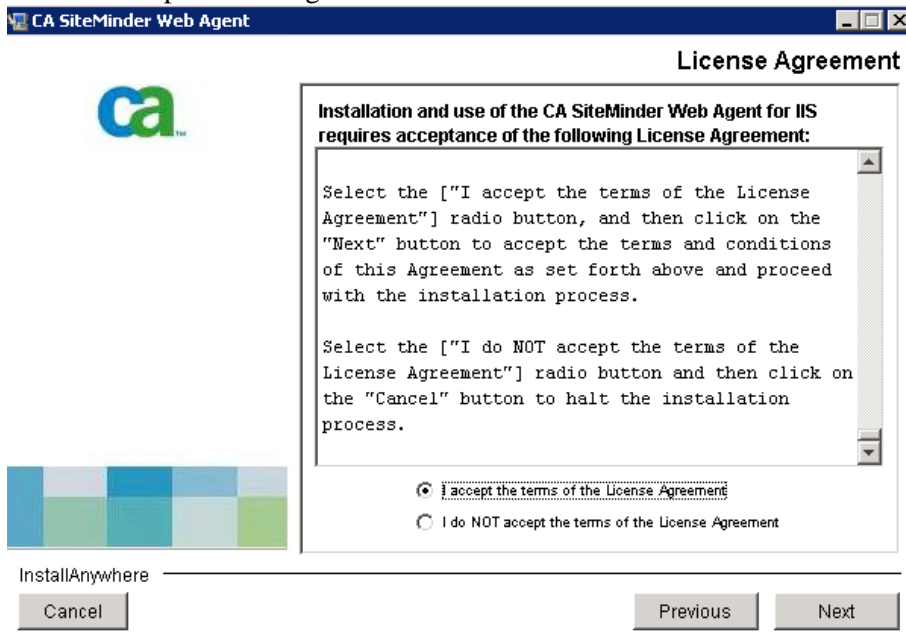

6. Select installation directory and click Next

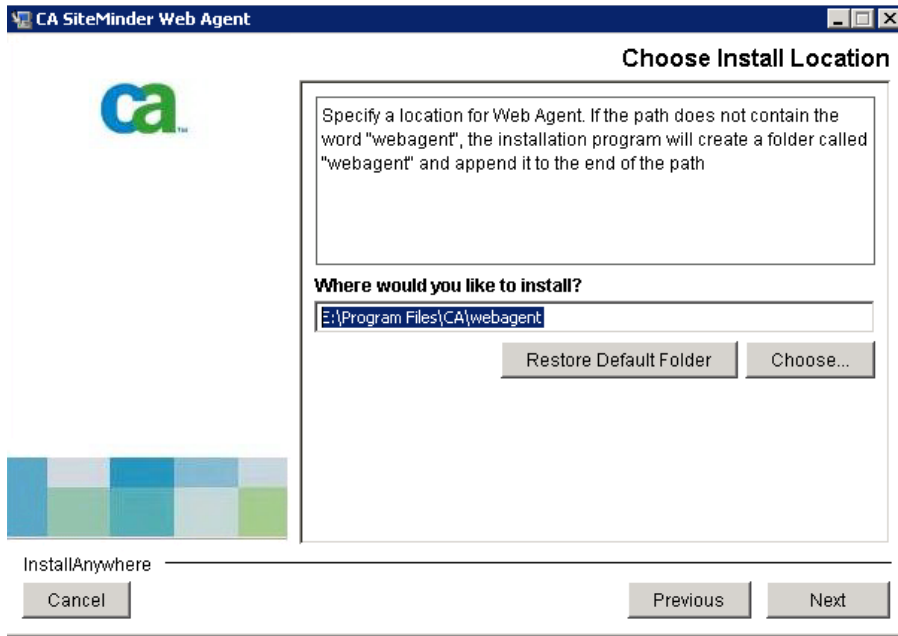

7. Review the information and Click Install on Pre-Install summary Window

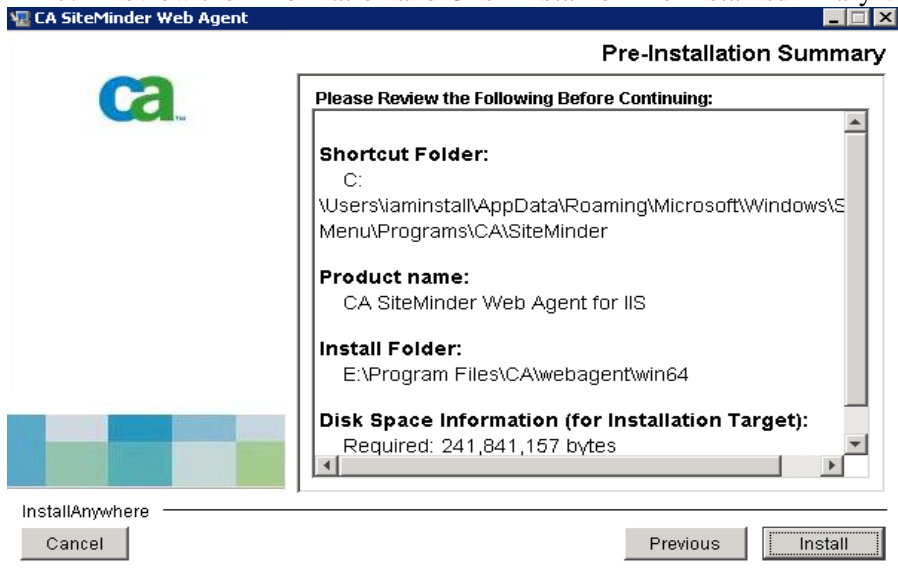

8. Click done on Install complete Window

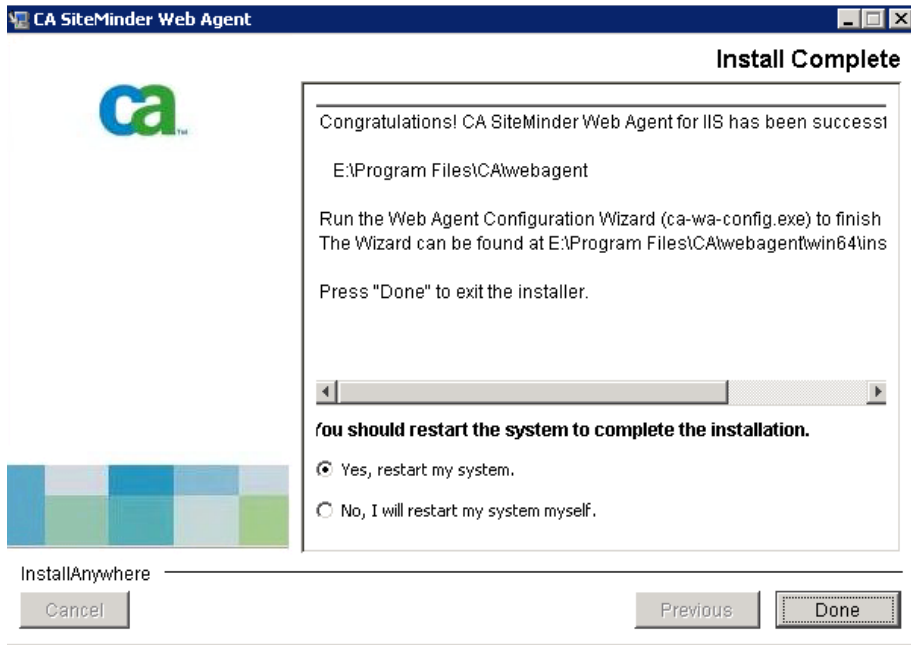

9. Configure the Web Agent)

- Right click on the “Web Agent Configuration Wizard”
- Select “Run as administrator”

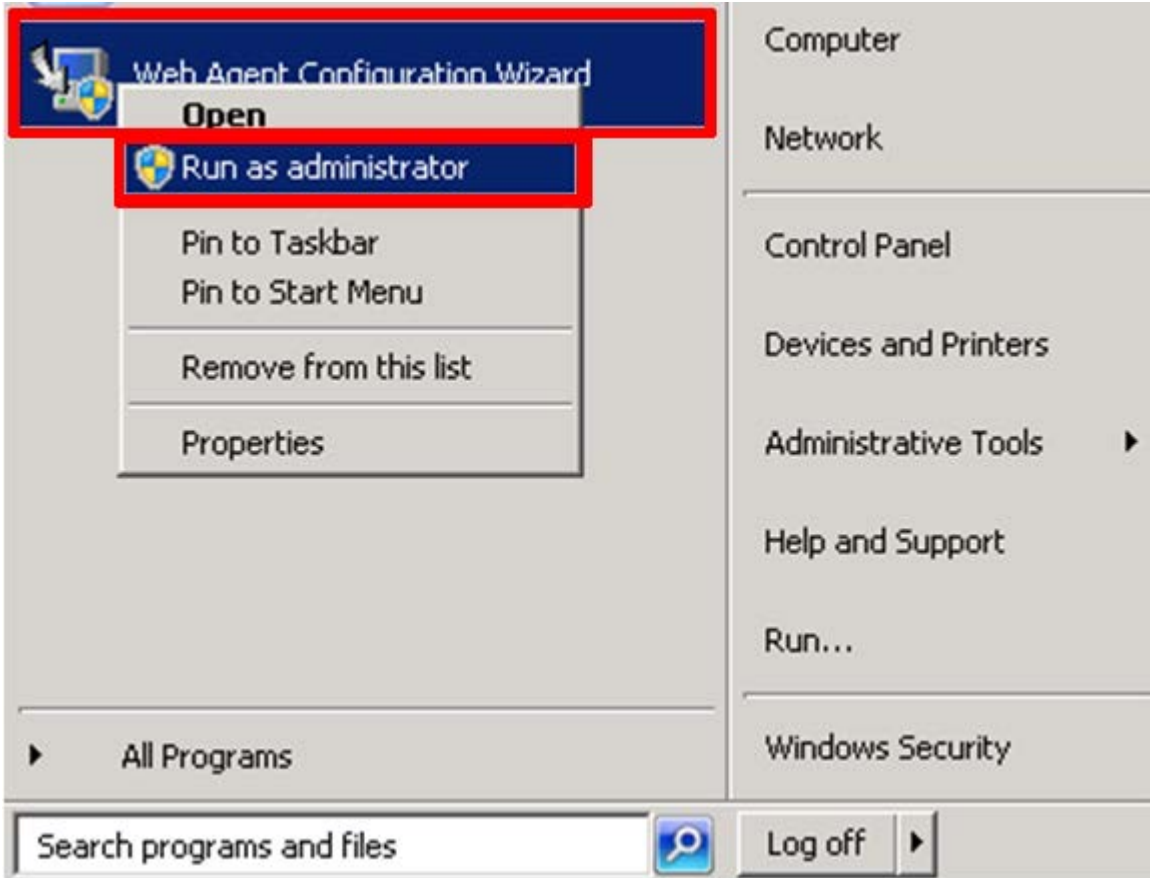

## 10. User Account Control

- Click “Continue”

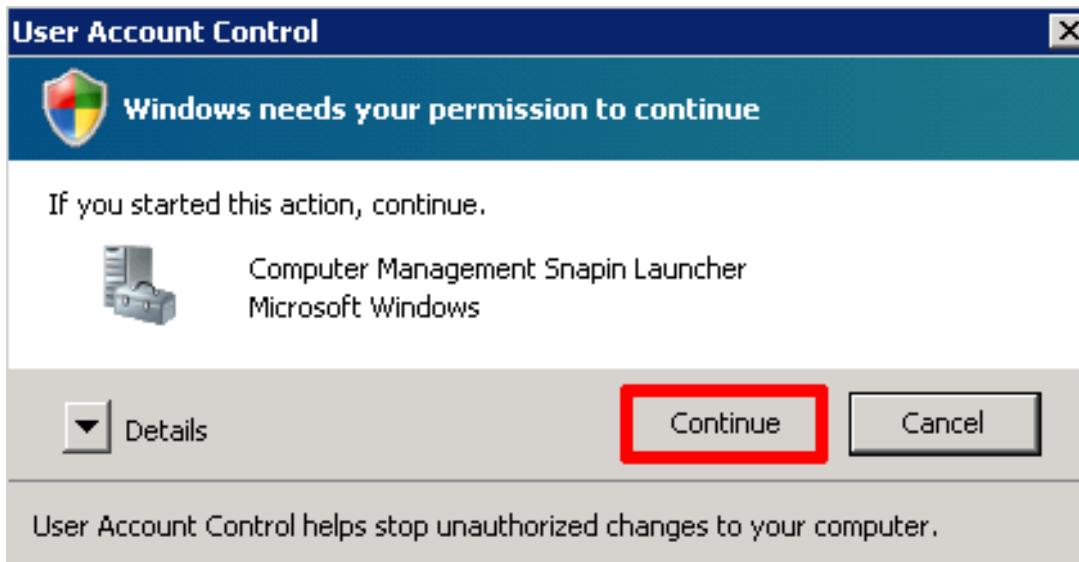



## 11. Host Registration

- Select “Yes, I would like to do Host Registration now”
- Click “Next”

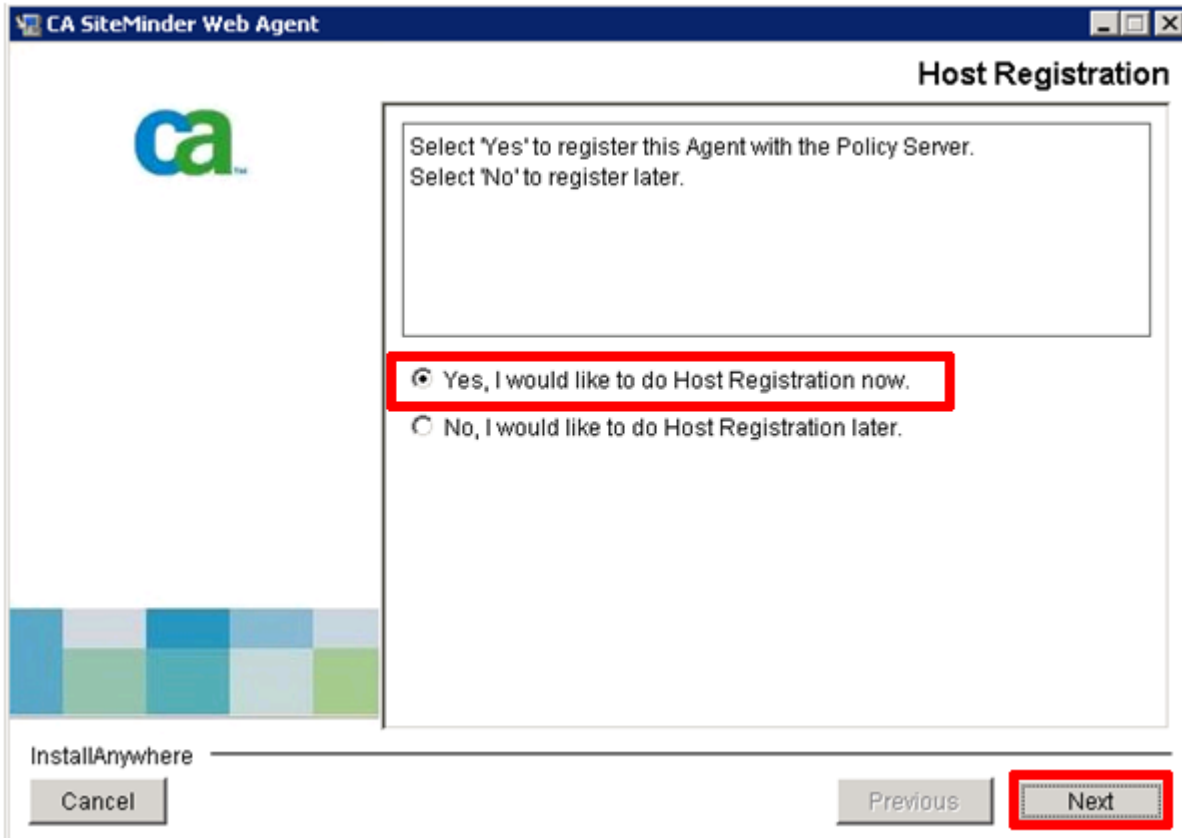

## 12. Admin Registration

- In the **Admin User Name**, **Admin Password** and **Confirm Admin Password** fields, enter the username and super user password created during the CA SiteMinder Policy Server Installation. Use below credentials:

Admin User Name: **XXXXXXXXXX**

Admin Password: **XXXXXX**

- Ensure the checkbox “**Enable Shared Secret Rollover**” is **UNCHECKED**
- Click “**Next**”

CA SiteMinder Web Agent

### Admin Registration

Enter the name and password of an administrator who has the right to register trusted hosts with the Policy Server. This entry must match the name of an administrator defined in the Policy Server.

Admin User Name: siteminder

Admin Password: \*\*\*\*\*

Confirm Admin Password: \*\*\*\*\*

Enable Shared Secret Rollover

InstallAnywhere

Cancel Previous **Next**

### 13. Trusted Host Name and Configuration Object

- Enter the **Trusted Host Name**.
  - Provide the hostname of the server you are installing the CA SiteMinder Web Agent on.
- Enter the name of the **Host Configuration Object** communicated to you :  
For ex: **DEVXXX**, **SQAXXX**, **Preprod\_ext** or **PROD\_external\_XXX**
- Click “Next”

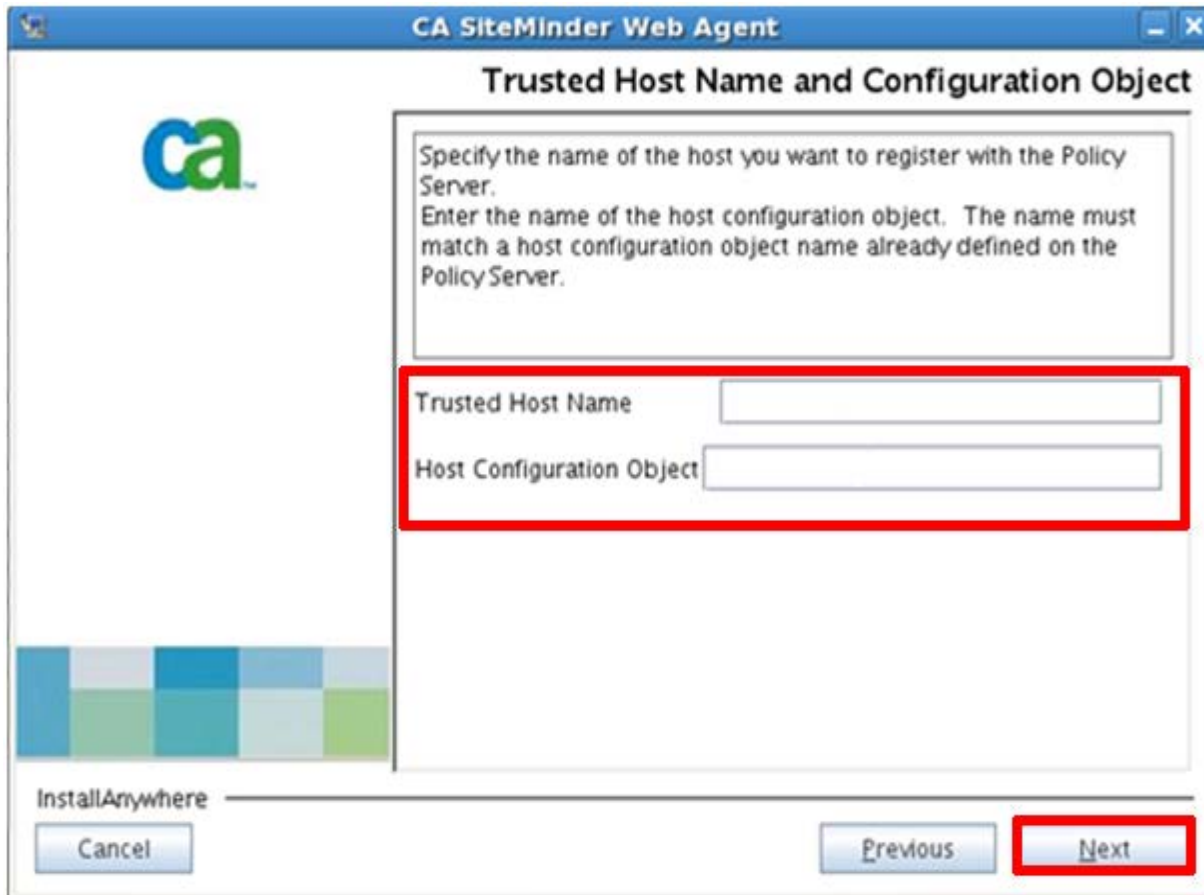

The screenshot shows a Windows-style window titled "CA SiteMinder Web Agent" with a sub-header "Trusted Host Name and Configuration Object". On the left is the CA logo. The main area contains a text box with instructions: "Specify the name of the host you want to register with the Policy Server. Enter the name of the host configuration object. The name must match a host configuration object name already defined on the Policy Server." Below this are two input fields: "Trusted Host Name" and "Host Configuration Object". A red rectangle highlights these two fields. At the bottom, there are three buttons: "Cancel", "Previous", and "Next". The "Next" button is also highlighted with a red rectangle. The "InstallAnywhere" logo is visible in the bottom left corner.

#### 14. Policy Server IP Address

- Enter the CA Siteminder **Policy Server IP Address** communicated to you:  
**For ex:**  
**xx.xxx.90.18**  
**xx.xxx.90.20**
- Click “Next”

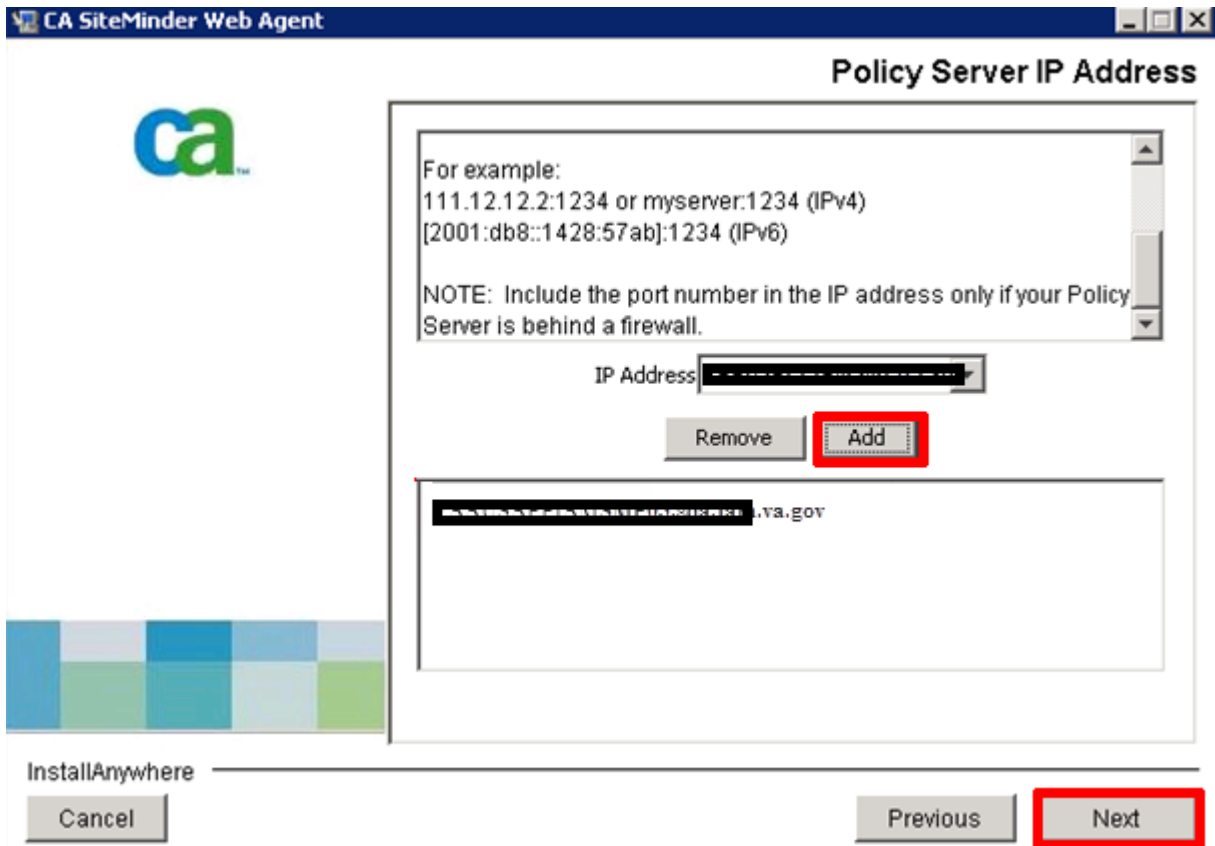

## 15. FIPS Mode Setting

- Select “**FIPS Only Mode**”
- Click “**Next**”

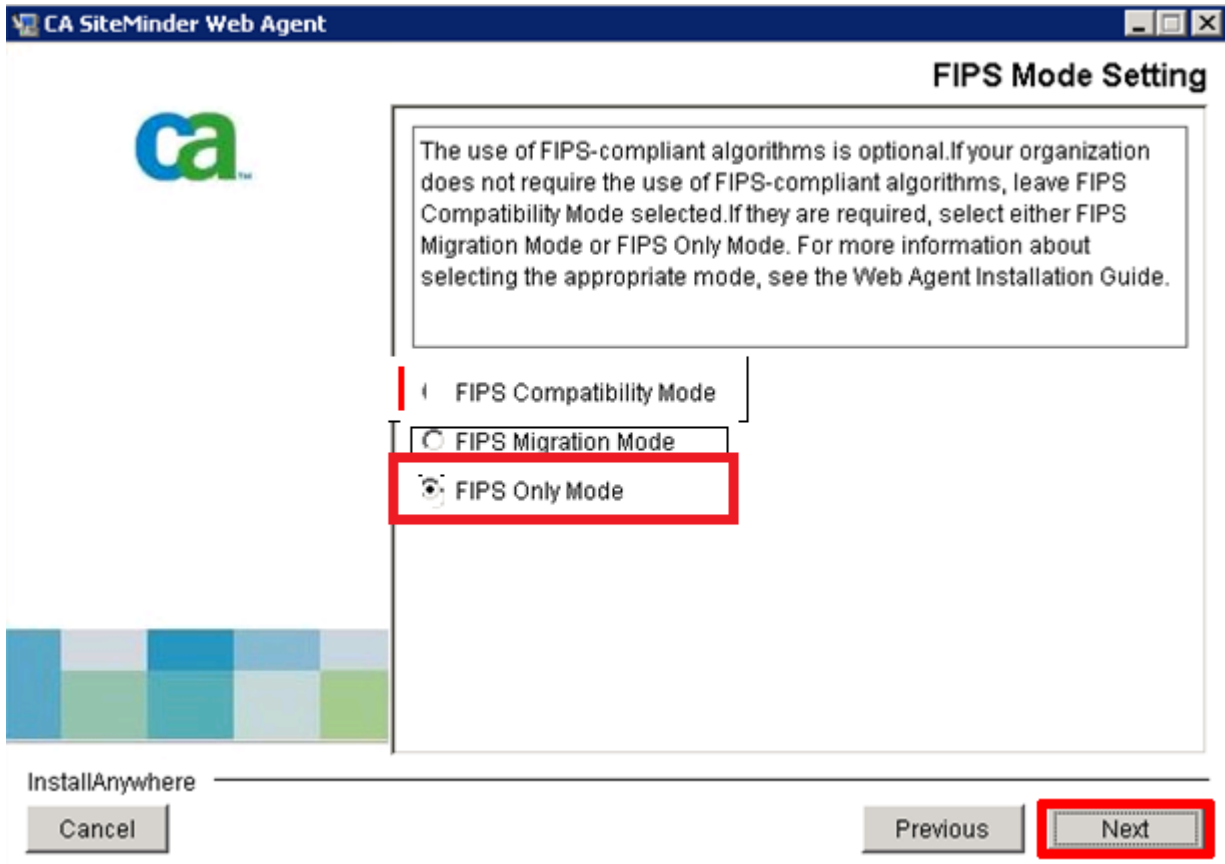

## 16. Host Configuration file location

- Select the **Web Agent Configuration file location**.
- Click “**Next**”

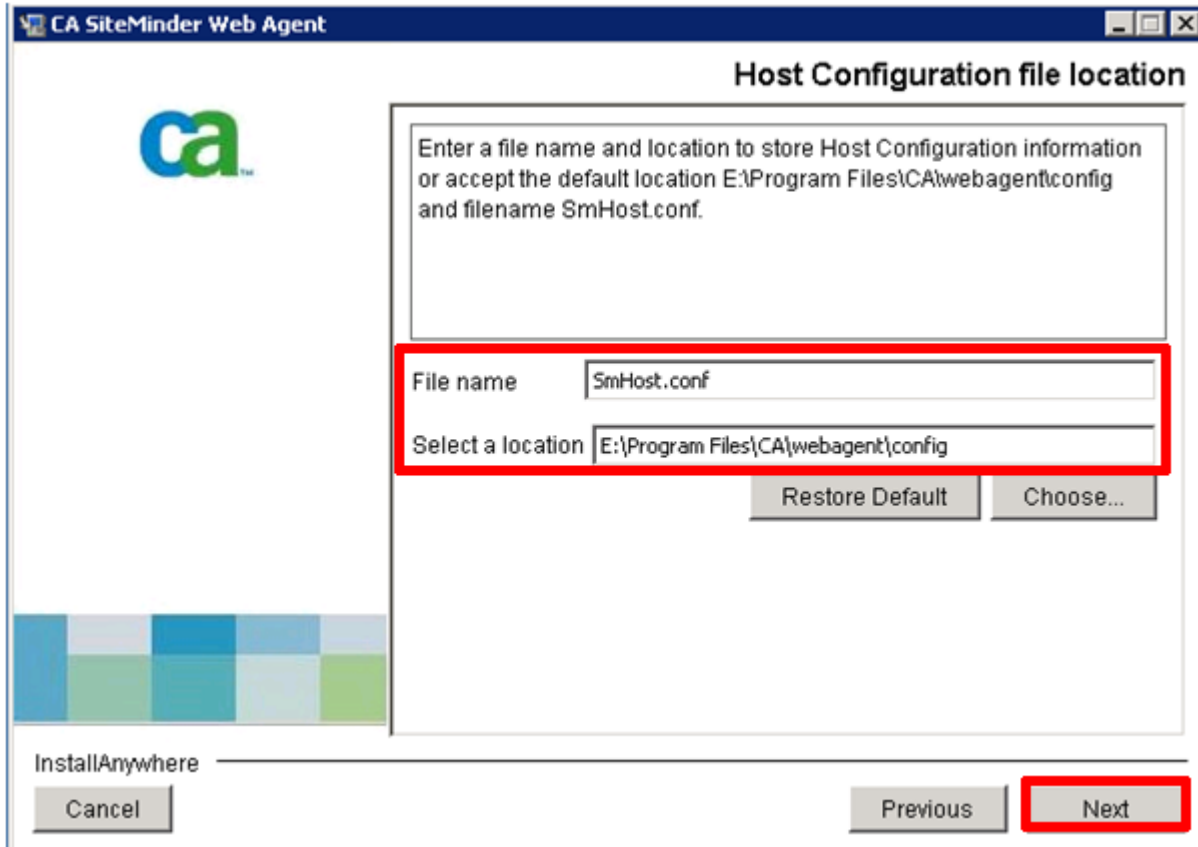

## Select available Virtual Site(s)

- Select the “Select All”

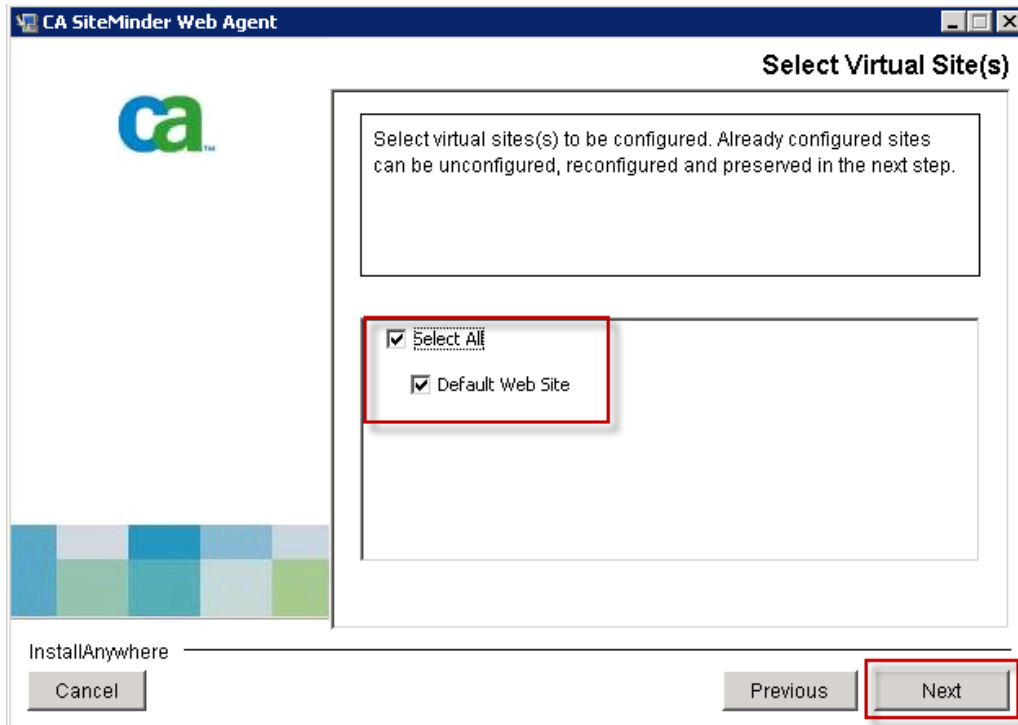

## 17. Agent Configuration Object

- Enter the name of the **Agent Configuration Object** communicated to you:  
**For Ex: BMSAgentConfig**
- Click “Next”

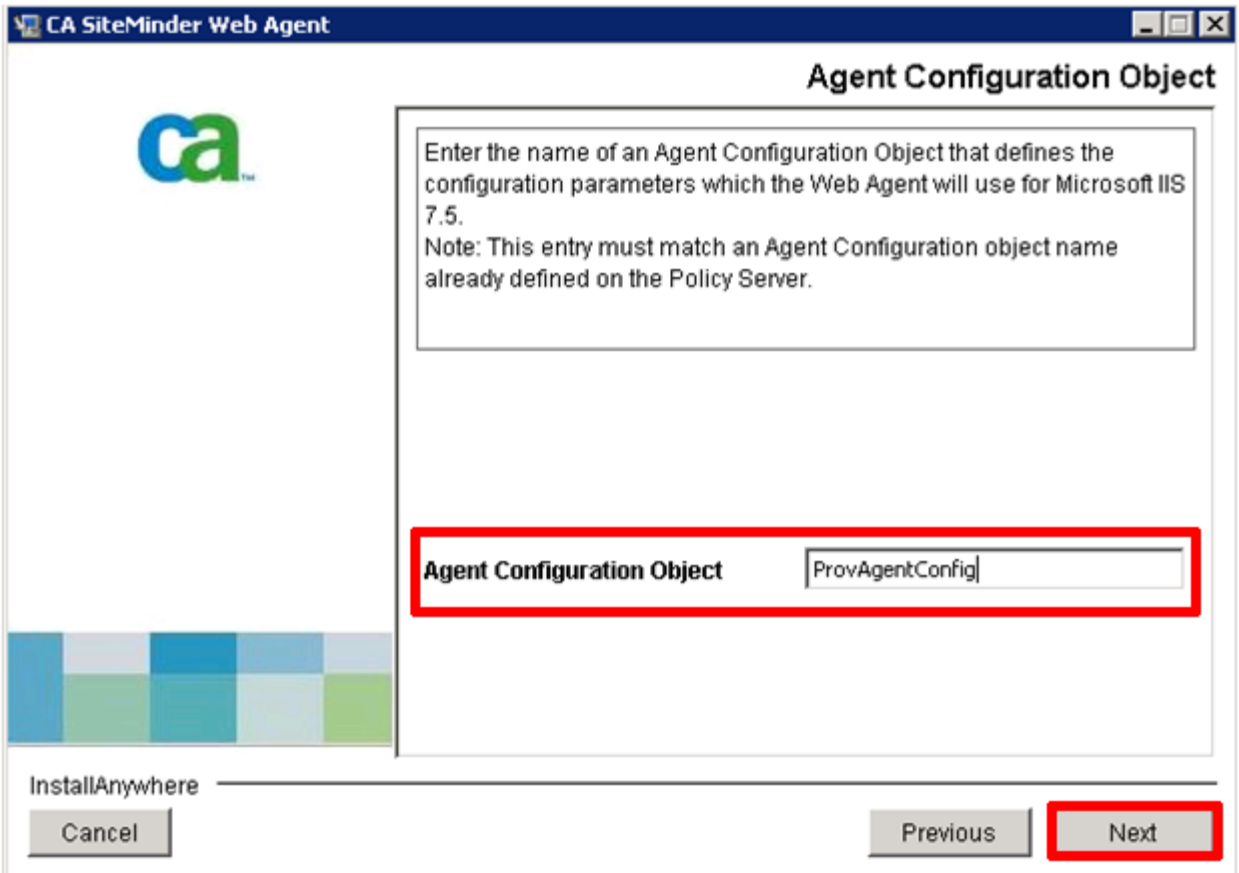



## 18. Self-Registration

- Select “No, I don’t want to configure Self Registration”
- Click “Next”

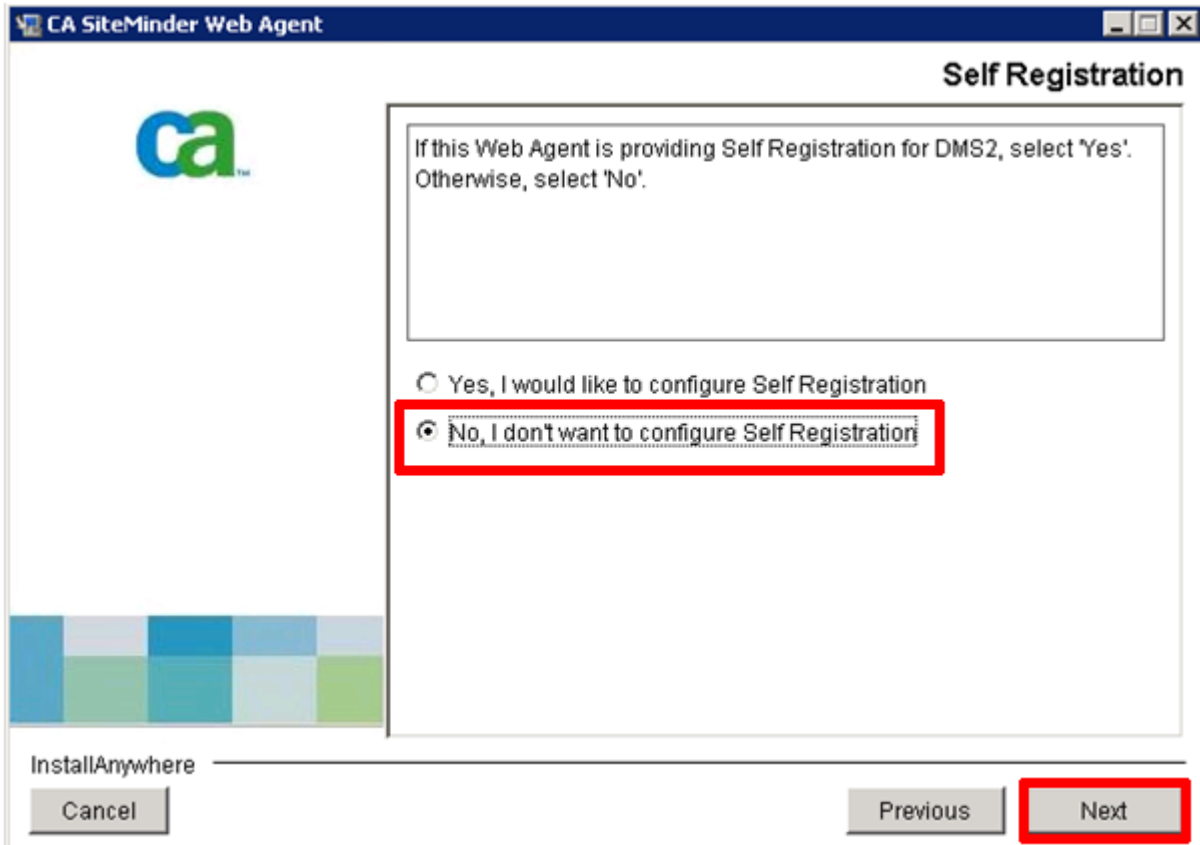

## 19. Web Server Configuration Summary

- Confirm the configuration selection, sample screen shot below
- Click “Install”

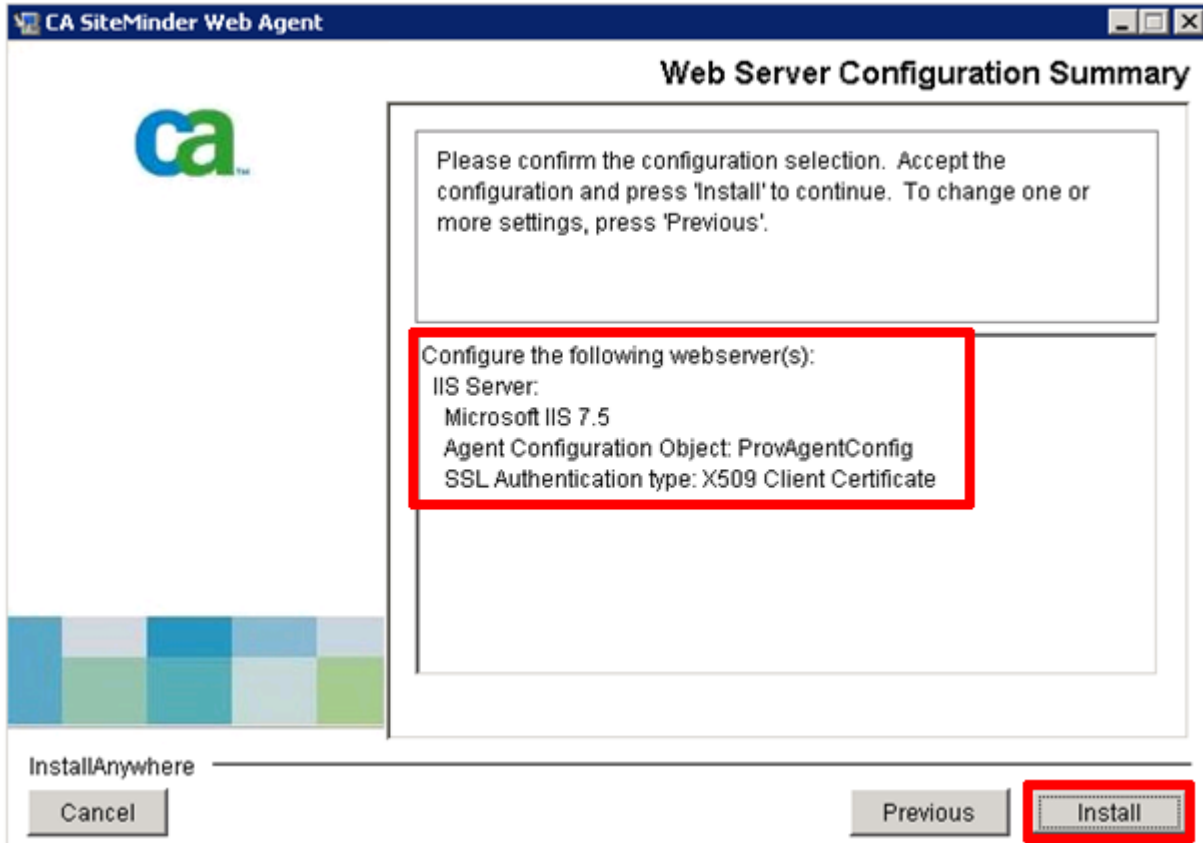

**20. Select the Web agent “Enable” checkbox and click Next**

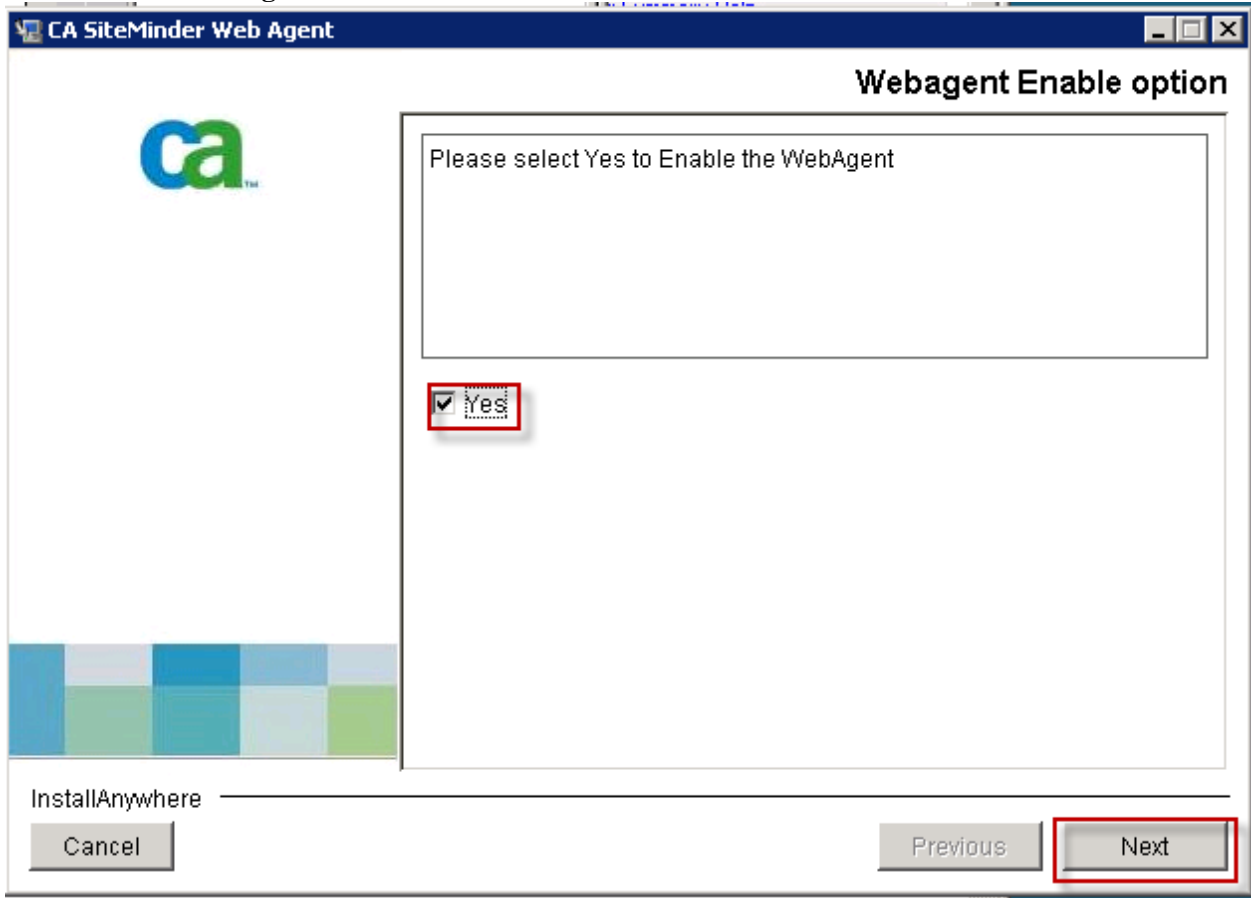

**21. Configuration Complete**

- Click “Done”

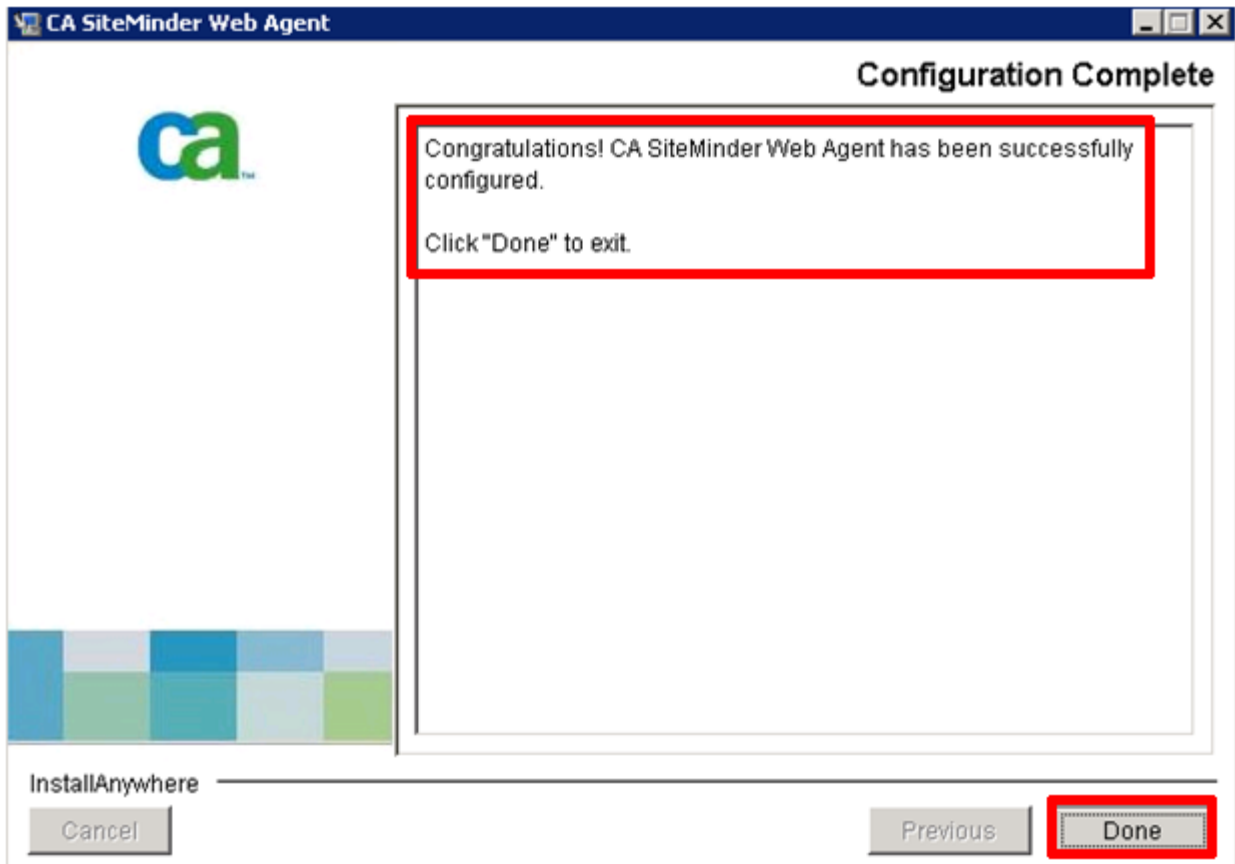

22. Restart the IIS server

## 9 Detailed Functional Model on Each Interface

### 9.1 Service contracts

#### Authentication

The security service for authentication is represented by STS – security token cache that will issue a token whether the authentication succeeded, otherwise it will deny access to the application server. This STS Service will authenticate the user through WS-Security and validate application servers through WS-Trust using SAML v2.0 Token (Security Assertion Markup Language).

#### Authorization

The security services for authorization are represented by a PDP and PAP implementation. PDP stands for policy decision point where the authenticated user can check the permission for a specified action on a specified resource. PAP stands for policy administration point. Here an administrative console can define actions, resource-types, roles and make associations with them (define security policies) that will server for PDP. The PDP service exposes one method: CheckAccess, whilst PAP service has specific functions for policy administration.

#### Detailed functional model on each interface

### STS – Security Token Service

- Authenticate

<b>Business friendly name</b>	User authentication
<b>Description</b>	The function decides if the user and the password supplied as parameters are valid. Will return true on success and false on any failure.
<b>Inputs</b>	Windows client credentials or Username – representing the username of the requested user. Password – the password of the requested user.
<b>Outputs</b>	True - on success False – on failure

### PDP – Policy Decision Point

- CheckPermission

<b>Business friendly name</b>	User authorization – check Access
<b>Signature</b>	<i>Message</i> CheckAccess( <i>Message</i> request);
<b>Description</b>	The function decides if the user has the privilege to access the specified action(s) on the specified resource.
<b>Inputs</b>	Username, operation name and resource id are encapsulated in the SAML Message class
<b>Outputs</b>	A Message containing the permit or deny result.

### PAP – Policy Administration Point

Name	Description	Input	Output
<b>AddRole</b>	Adds a role	<i>String</i> name – name of the new role <i>String</i> description – role description	<i>String</i> – new role’s id
<b>Delete Role</b>	Delete a role	<i>String</i> id – role’s id	<i>String</i> – deleted role’s id
<b>Update Role</b>	Update a role	<i>String</i> id – role’s id <i>String</i> name – role’s name <i>String</i> description –role’s description	<i>bool</i> – operation result: <i>true</i> on succeeded; <i>false</i> if any error aroused
<b>Update Task</b>	Update a task	<i>String</i> id – task’s id <i>String</i> name –task’s name <i>String</i> description – task’s description	<i>bool</i> – operation result: <i>true</i> on succeeded; <i>false</i> if any error aroused
<b>Update Operation</b>	Update an operation	<i>String</i> id – operation’s id <i>String</i> name – operation’s name <i>String</i> description – operation’s description	<i>bool</i> – operation result: <i>true</i> on succeeded; <i>false</i> if any error aroused
<b>IsChild</b>	Verifies if the sent operation is part of a task	<i>String</i> id – operation id	<i>bool</i> – operation result
<b>Assign User</b>	Assign an user to a role	<i>String</i> userId – user’s id (SID) <i>String</i> roleId – role’s id	-
<b>DeassignUser</b>	Delete an association between an user and a role	<i>String</i> userId – user’s id (SID) <i>String</i> roleId – role’s id	-
<b>Grant Permission</b>	Grant access to a resource for a role on an	<i>string</i> resourceId, <i>string</i> actionId, <i>string</i> roleId	-

	action		
<b>Revoke Permission</b>	Revokes a permission	<i>string</i> resourceId, <i>string</i> actionId, <i>string</i> roleId	-
<b>GetRoles</b>	Returns a list with all stored roles	<i>Bool</i> assignedOnly - returns assigned roles if parameter is true	<i>List&lt;Role&gt;</i> - retrieved roles
<b>Get Operations</b>	Returns a list with all stored operations	-	<i>List&lt;Operation&gt;</i> - retrieved operations
<b>GetTasks</b>	Returns a list with all stored tasks	-	<i>List&lt;Task&gt;</i> - retrieved tasks
<b>Add Operation</b>	Add a new operation	<i>String</i> name – operation’s name <i>String</i> description – operation’s description	<i>String</i> id – operation’s id
<b>Delete Operation</b>	Delete an operation	<i>String</i> – operation’s id	-
<b>AddTask</b>	Add a new task	<i>String</i> name – task’s name <i>String</i> description – task’s description	<i>String</i> id– tasks’s id
<b>Delete Task</b>	Delete a task	<i>String</i> id– tasks’s id	-
<b>Assign Operations</b>	Associate operations to a task	<i>List&lt;String&gt;</i> operationIds – list of operations to be assigned <i>String</i> taskId – task’s id	-
<b>DeassignOperations</b>	Deassign operations from a task	<i>List&lt;String&gt;</i> operationIds – list of operations to be assigned <i>String</i> taskId – task’s id	-
<b>GetTaskDefinition</b>	Retrieve a list with all operations of the specified task	<i>String</i> id– tasks’s id	<i>List&lt;DefinitionBase&gt;</i> - operation list
<b>GetRole Definition</b>	Returns all associated operations to a specified role	<i>String</i> roleId – role’s id	<i>List&lt;DefinitionBase&gt;</i> - operation list
<b>GetRole ByName</b>	Returns a role by name	<i>String</i> name – role’s name	<i>Role</i> – returned role
<b>GetRole ByName ExcludingId</b>	Returns a role by name excluding the role id sent by parameter	<i>String</i> name – role’s name <i>Guid</i> id – role’s id	<i>Role</i> – returned role
<b>GetTask ByName</b>	Returns a task by name	<i>String</i> name – task’s name	<i>Task</i> – returned task
<b>GetTask ByName ExcludingId</b>	Returns a task by name excluding the task id sent by parameter	<i>String</i> name – task’s name <i>Guid</i> id – task’s id	<i>Task</i> – returned task
<b>Get Operation ByName</b>	Returns an operation by name	<i>String</i> name – operation’s name	<i>Operation</i> – returned operation
<b>Get Operation ByName ExcludingId</b>	Returns an operation by name excluding the operation id sent by parameter	<i>String</i> name – operation’s name <i>Guid</i> id – operation’s id	<i>Operation</i> – returned operation
<b>Get Permissions By Resource Type</b>	Returns a list with operations/task associated with a resource type	<i>String</i> resourceType – Resource type	<i>List&lt;DefinitionBase&gt;</i> – operation/task list
<b>GetPolicy</b>	Returns a list with all roles and operations associated with the resource	<i>String</i> resourceId – resource’s id	<i>List&lt;Role&gt;</i> – role list. Each role has the associated operations.
<b>GetRole Users</b>	Returns a list with all users associated to a	<i>Guid</i> roleId – role’s id	<i>List&lt;User&gt;</i> – user list

	specific role		
<b>Assign Role</b>	Marks a role as assigned	<i>Guid</i> roleId – role’s id	-
<b>Deassign Role</b>	Marks a role as unassigned	<i>Guid</i> roleId – role’s id	-
<b>Get Connected RolesAndOperations</b>	Returns a list with all roles and operations associated with the resource	<i>String</i> resourceId – resource’s id	<i>List&lt;Role_Operation&gt;</i> – list with role-operations associations
<b>Clear Permissions For Resource</b>	Removes all permissions for a certain resource (all associations to this resource)	<i>String</i> resourceId – resource’s id	-
<b>Delete PermissionFor Resource And Operation</b>	Deletes a permission form a role based on the resource and operation sent.	<i>String</i> resourceId – resource’s id <i>String</i> roleId – role’s id <i>String</i> actionGUID – opetation’s id	-
<b>Insert PermissionFor Resource And Operation</b>	Creates a permission for a certain role and an operation on a resource. It automatically creates the association within the permission and the operation if it doesn’t exist.	<i>String</i> resourceId – resource’s id <i>String</i> roleId – role’s id <i>String</i> actionGUID – opetation’s id	-

The security services do not expose a fault contract as usual web services do. Instead, these services deliver information about any issue in processing the request in the return message of the service call (such as authentication error, authorization error etc.).

# Data contracts

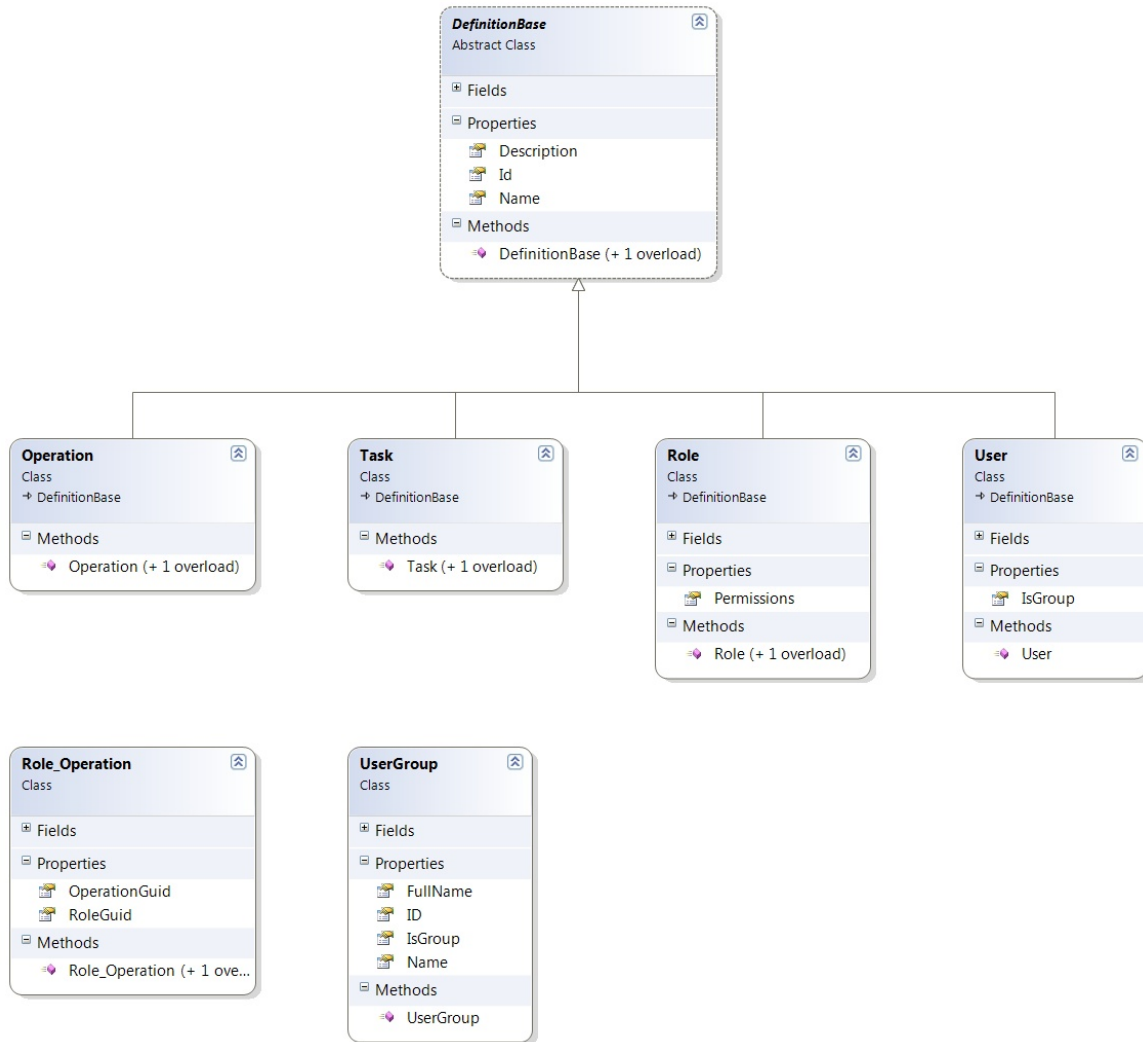

Figure 52 – Class diagram for data contracts in PAP and PDP

## 9.2 BMS Roles

BMS users fall under the following categories:

**Administrators:** This type of user will customize the BMS settings according to the needs of a facility. They will have access to the Site Options pages. This role refers to a group of users whose members are the person(s) responsible for setting up BMS options for the current facility.

**AuditLogUsers:** This type of user will have access to Audit Log Report. This role cannot be used alone, only together with another role.

**EmsStaff:** The EMS group of users will be allowed to edit and update the bed cleaning process but not the other parts of the bed board. Any member of your EMS staff that will be interacting with BMS must be in this group.



**EMSSupervisorUsers:** The EMS supervisor group of users will be allowed to view the requests for bed clean operations, to filter existing requests by different criteria and to select requests in order to assign them to EMS staff. This role cannot be used alone, only together with EmsStaff role.

**Guests:** The guest user will be allowed to generate the National Bed Availability report from National/Regional page.

**National Users/Regional Users:** This type of user will have access to the National/Regional page only.

**Site Users:** This type of user only has access to the BMS facility page.

**Support Users:** This type of user will have access to the Administrative page of the BMS solution. They configure the sites for the BMS facilities and grant access and read/write rights to the users.

**VISN Users:** This type of user will have access to the pages of different facilities within the VISN where they have been granted access.

## 9 Troubleshooting

This section contains information on common issues with using BMS solution and how those may be resolved.

### Symptom 1

When you try to load the BMS application, one of the following error messages appear:

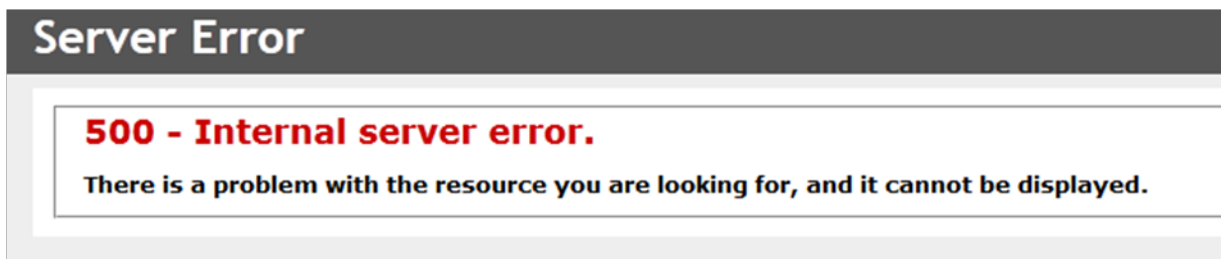

### Problem

IIS is not started/running.

### Diagnoses and Solutions

### Figure 53: 500 Internal Server Error

Start the IIS Manager and check if the Application Pool Identity is set to the correct service account. ().  
Verify the BMS pool is started, If stopped right click on the BMS, Select 'Start'.

Verify the Site 'BMS' is started. If not select 'BMS' under the Site folder in IIS Manager, select 'Start' from the 'Manage Web Site' panel on the right side of the IIS Manager.

## Symptom 2

When trying to load the BMS application, one of the following error messages appears:

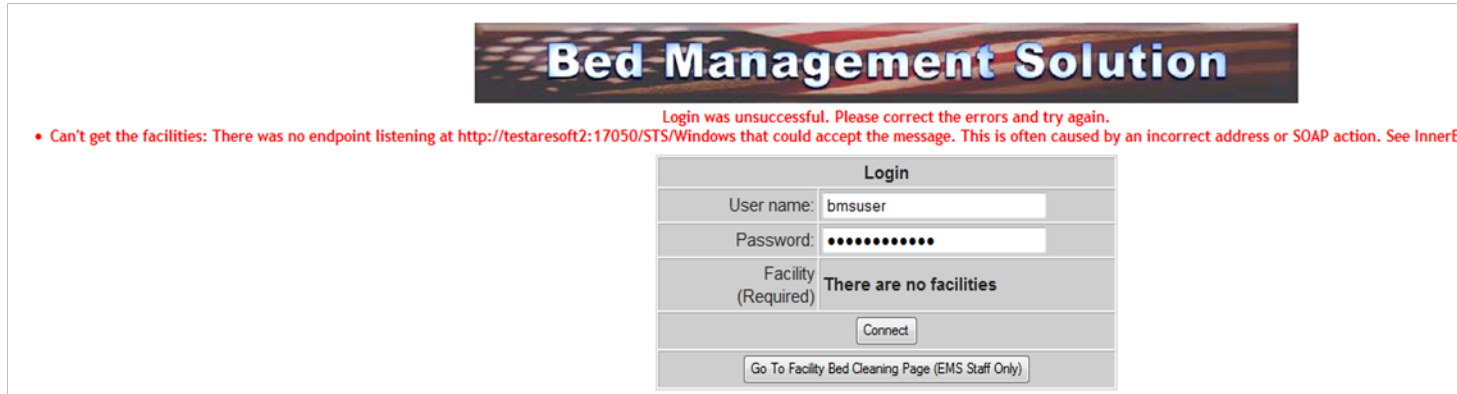

Figure 54: There are no Facilities

## Diagnoses and Solutions

Go to the APPx200 machine and check if the BMS.ServiceHost service is stopped. Start the services.msc console and start the service.

Verify the service started.

## Symptom 3

When trying to load the BMS application, one of the following error messages appears:

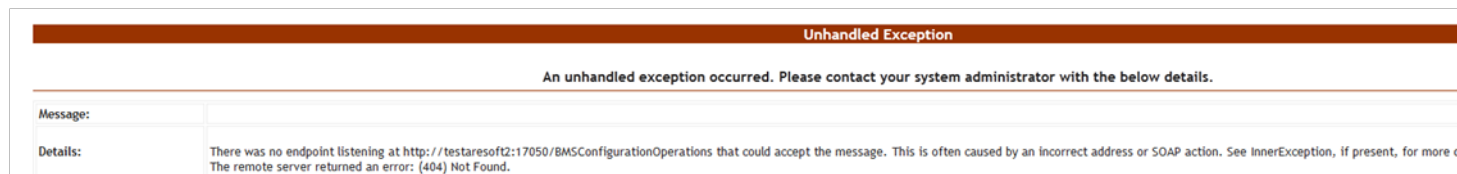

## Diagnoses and Solutions

Figure 55: Unhandled Exception

- Check if BMS.BMService service is stopped or SQL Server might also have stopped.
- Go to the SQL Server machine and start the SQL Server from the SQL Server Configuration Manager. Verify if the connection string to the database server is set properly.
- Then go to the services' machine, start the services.msc console and start the BMS.BMService service.

#### Symptom 4

When trying to log-in to the BMS application, the following error is displayed:

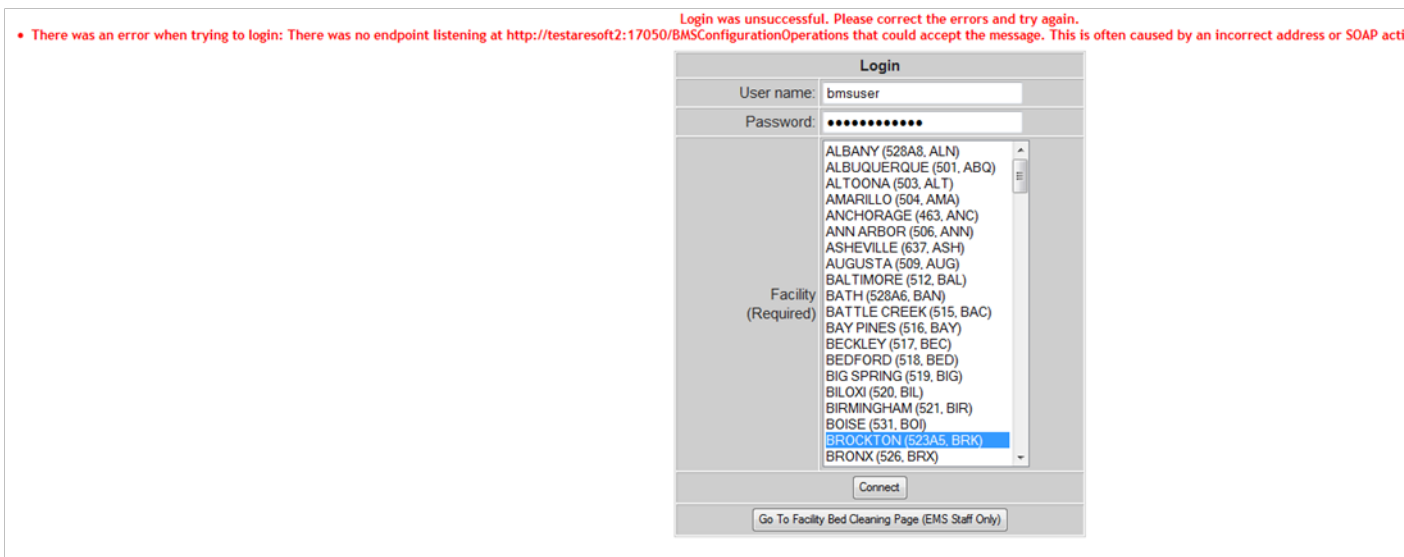

#### Diagnoses and Solutions

Figure 56: Login Unsuccessful

Check if BMS.BMService service is stopped. Go to the services' machine, start the services.msc console and start the service.

**Symptom 5**

Data does not appear in the reports. Data does not get refreshed in the reports.

**Diagnoses and Solutions**

In SQL Configuration Manager, check if the SQL Server Agent is started, and if it isn't start it; then, in the SQL Server Management Studio, check if the *BMS - Reports Full* and *BMS - Reports Incremental* are deployed and run without errors. If the jobs are not deployed, install them.

**Symptom 6**

A report is missing from Other Reports section on the Facility Home Page (e.g. *EMS Bed Status Report (Admin)*).

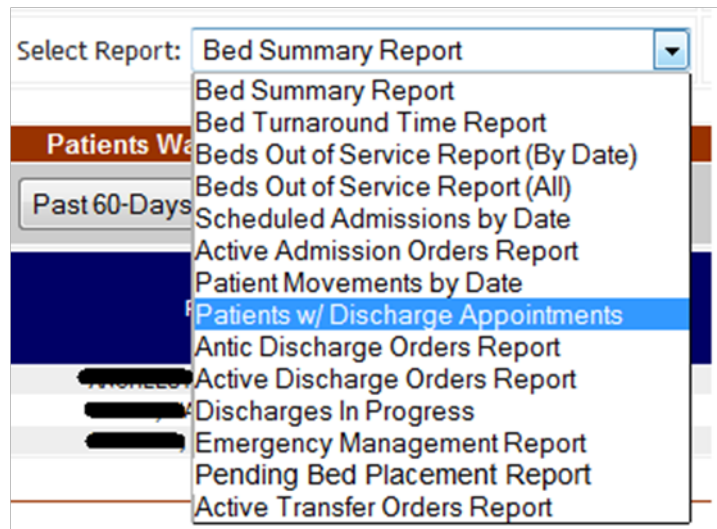

**Diagnoses and Solutions**

## Figure 57: EMS Bed Status Report is Missing

Check if the report is missing from the SQL Server Reporting Services. Go to the management web page and add the missing report (Upload File).

### Symptom 7

When trying to view one of the reports (other than the *Other Reports*) the following error appears:



### Diagnoses and Solutions

Figure 58: Report Cannot be Found

Check if the mentioned report is missing from the Reporting Services. Go to the management web page and add the specified report.

**BMS Log Files**

There are five log files available to anyone supporting the BMS system, the **WinServiceHost**, the **SecurityHost**, the **BMS.ServiceHost**, the **BMS.VI.ServiceHost** and the **WebTrace log**.

- The WinServiceHost log file is named BMS-Services.log and its location is on the application server (<servername>) D:\BMS\Bin.
- The SecurityHost log file is named BMS-Security.log and its location is on the application server (<servername>) D:\BMS\Bin.
- The BMS.ServiceHost logfile is named BMS.trace.log and its location is on the application server (<servername>) at D:\BMS\Bin\BMS.
- The BMS.VI.ServiceHost logfile is named BMS.VI.trace.log and its location is on the application server (<servername>) at D:\BMS\Bin\BMS.
- The Web trace log is named WebTrace.log and its location is on the web server (<servername>) at D:\BMS\BMS.Web.

These logs contain various types of information (informational, warnings, and errors) with the exception of the web trace log, which only contains error messages.

There is no log file for MDWS, those errors are captured through our integration calls and posted in the BMS.ServiceHost log file (Trace.log). These are bit more tricky to debug as in any attempt requires the exact parameters to be passed to MDWS.

## 10 Appendix A – BMS Diagrams

### 10.1 Business Process Diagrams

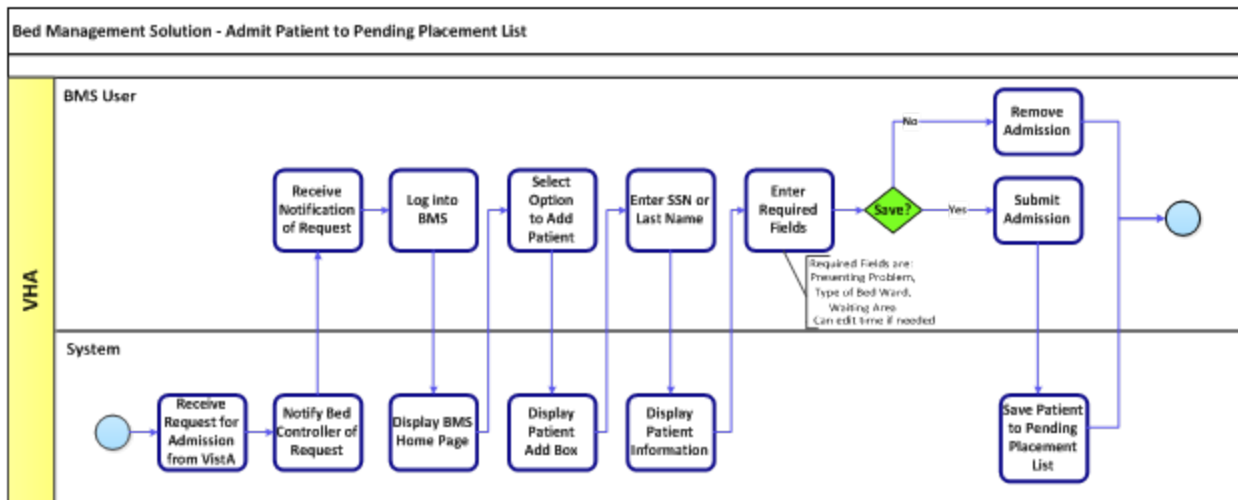

Figure 59: Admit Patient to Patients Pending Bed Placement Business Process

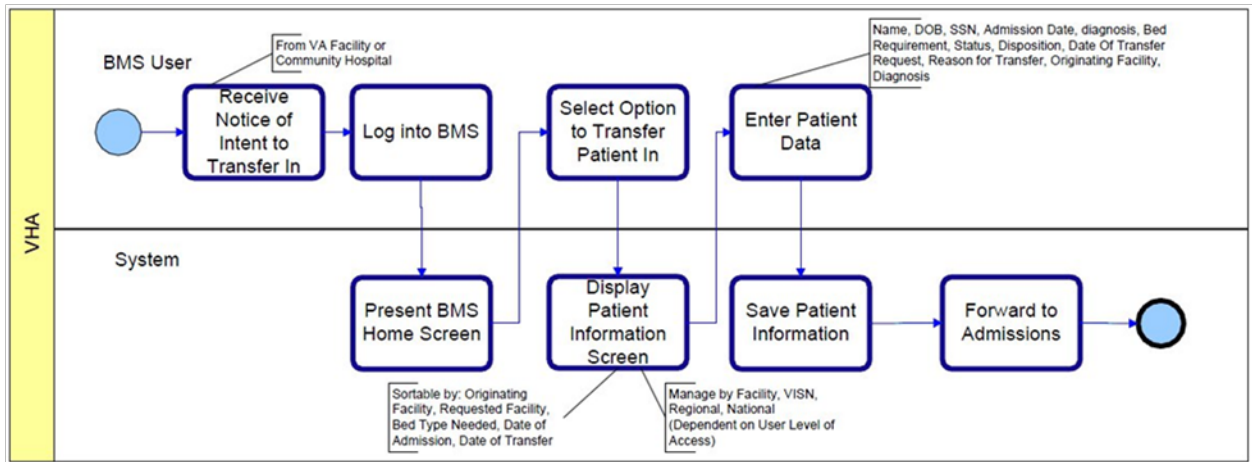

Figure 60: Transfer Patients Pending Bed Placement Business Process

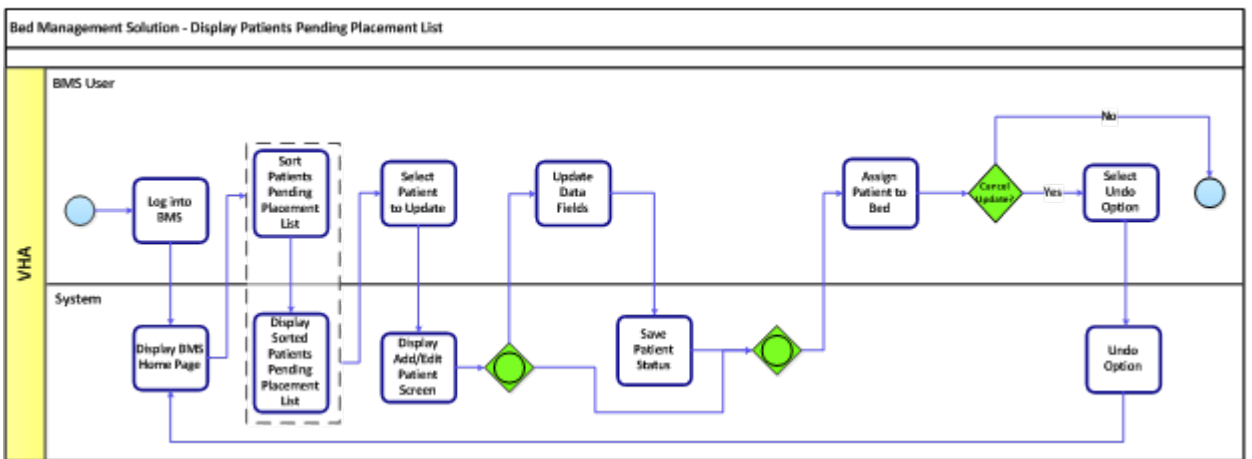

Figure 61: Display and Update Patients Pending Bed Placement Business Process



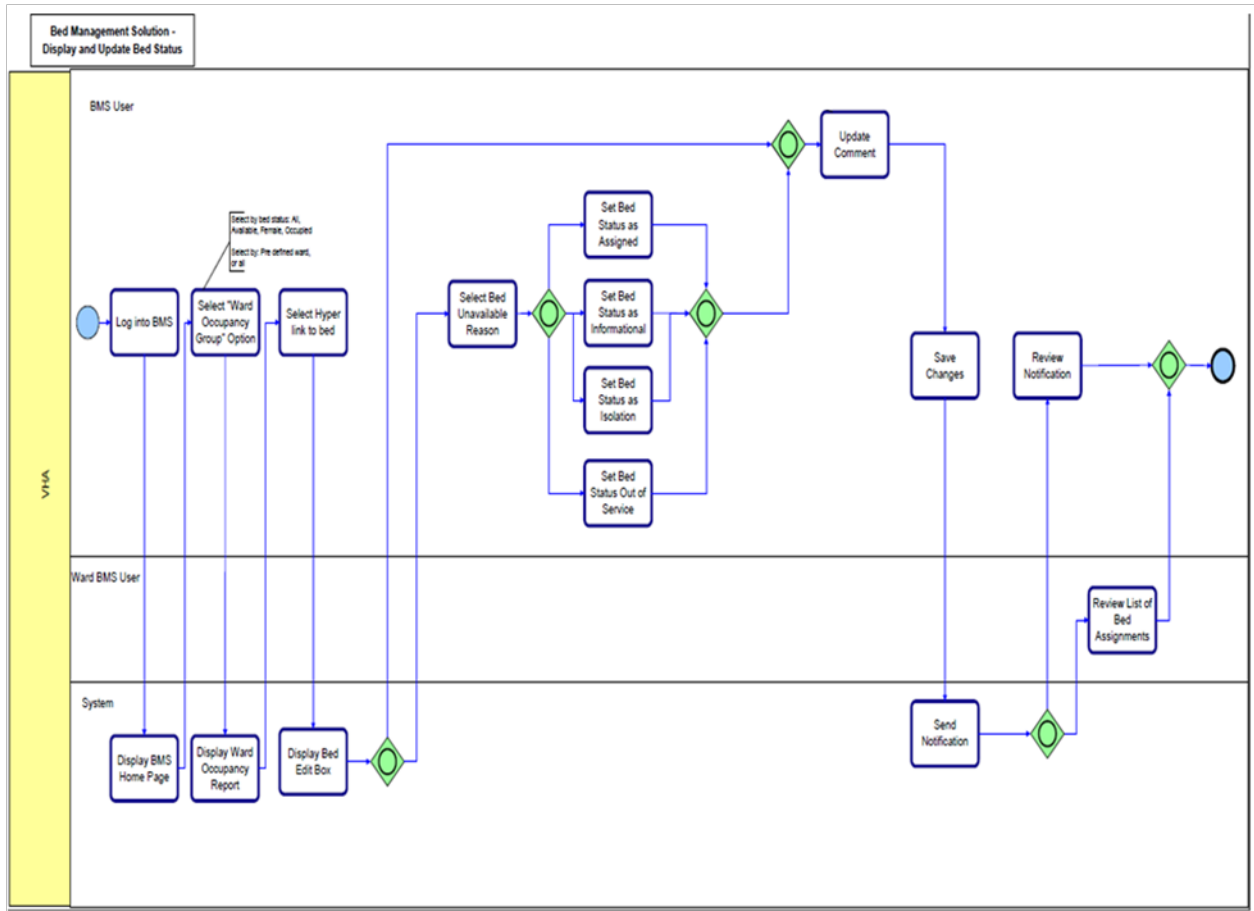

Figure 62: Display and Update Bed Status Business Process

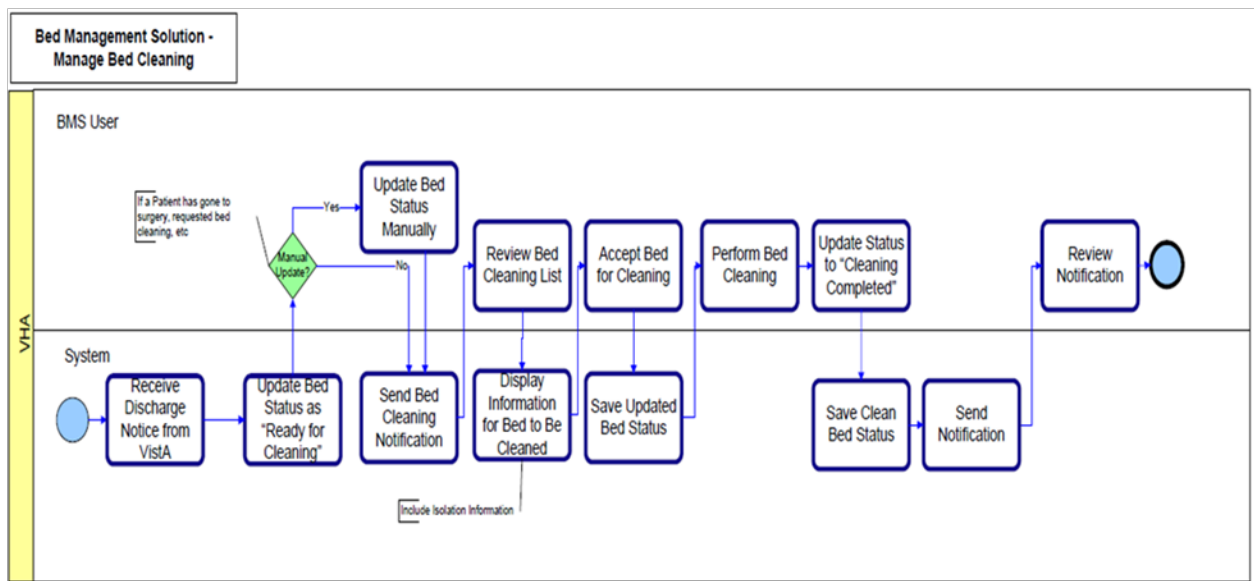

Figure 63: Manage Bed Cleaning Business Process

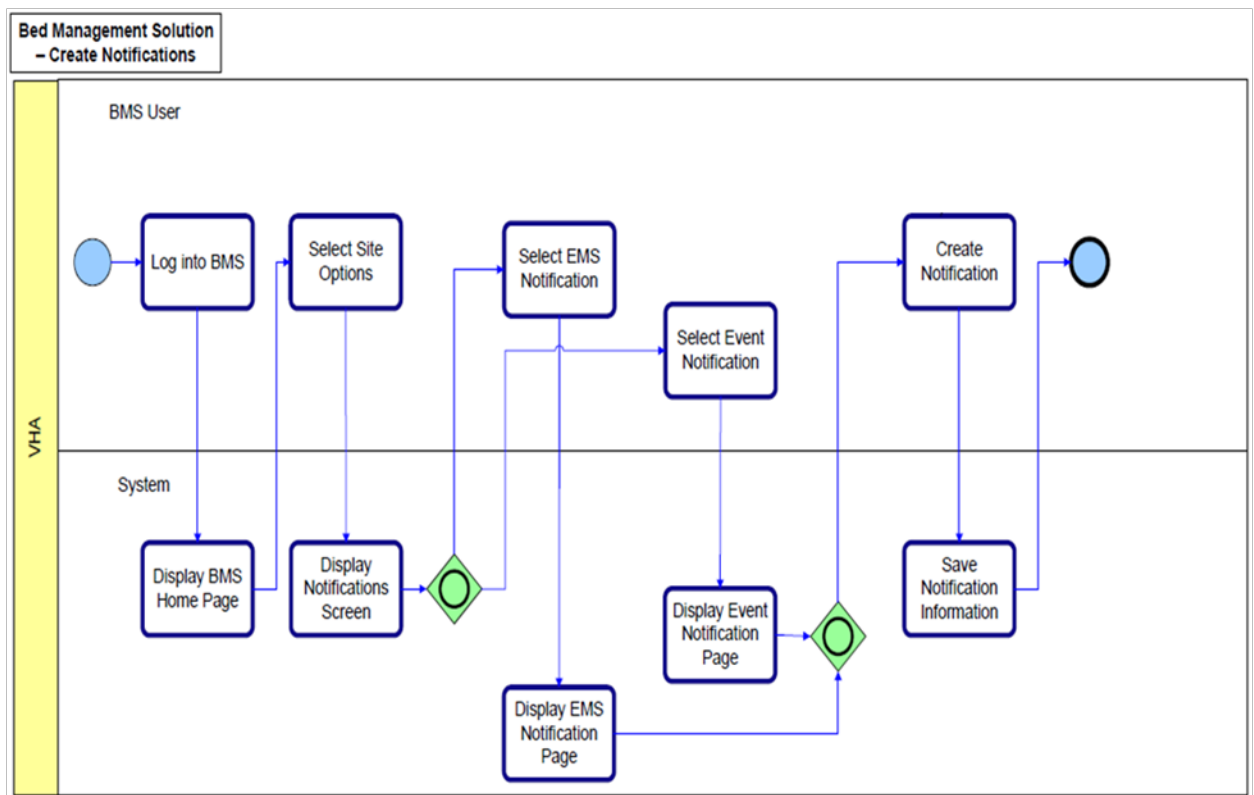

Figure 64: Create Notification Business Process

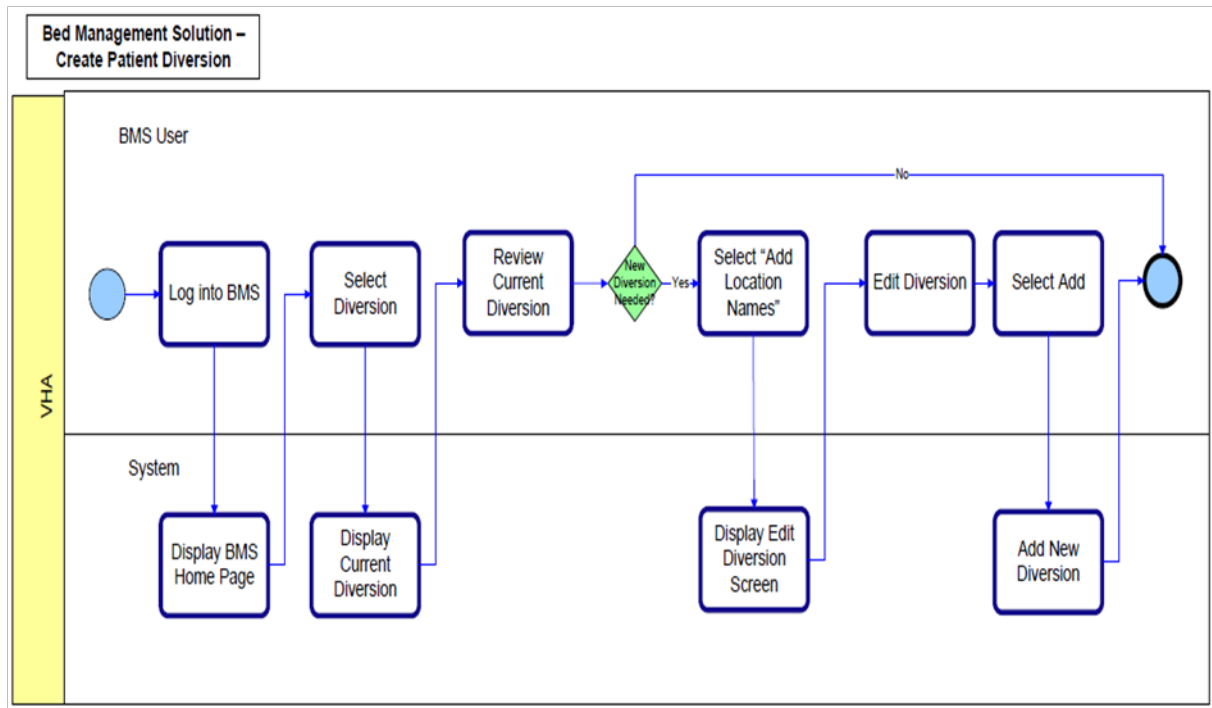

Figure 65: Create Facility Diversion Business Process

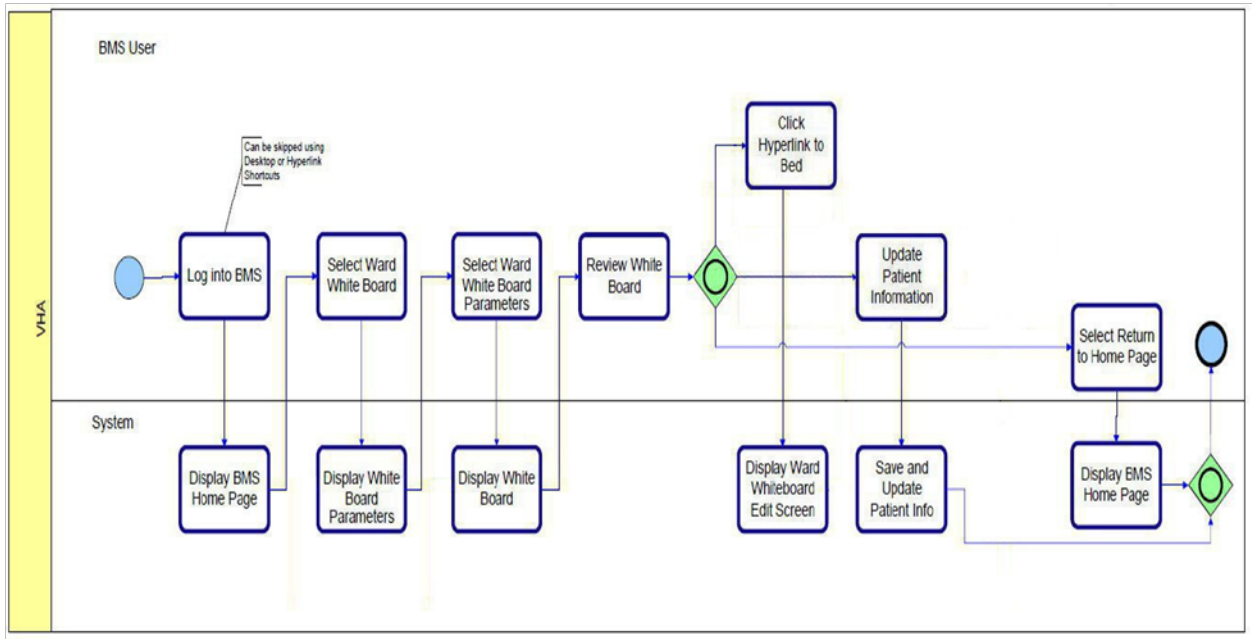

Figure 66: Manage Whiteboard Business Process

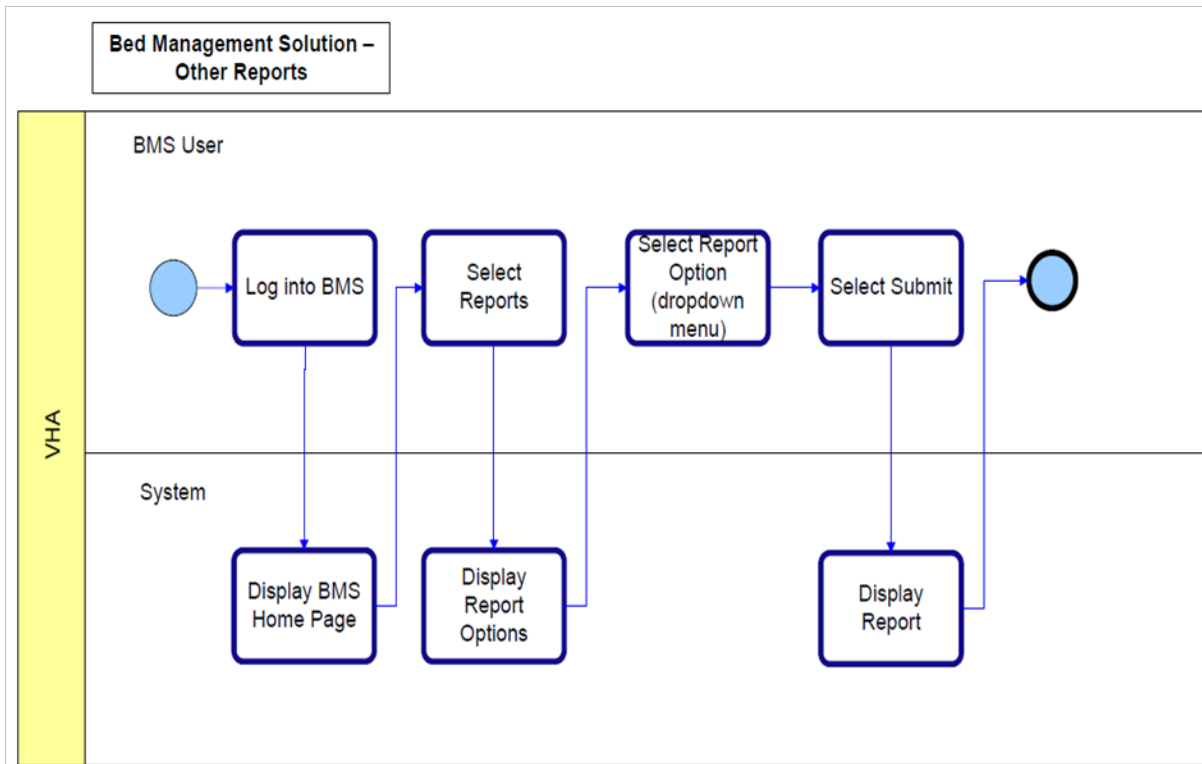

Figure 67: Reports Business Process

## 10.2 Activity Diagram

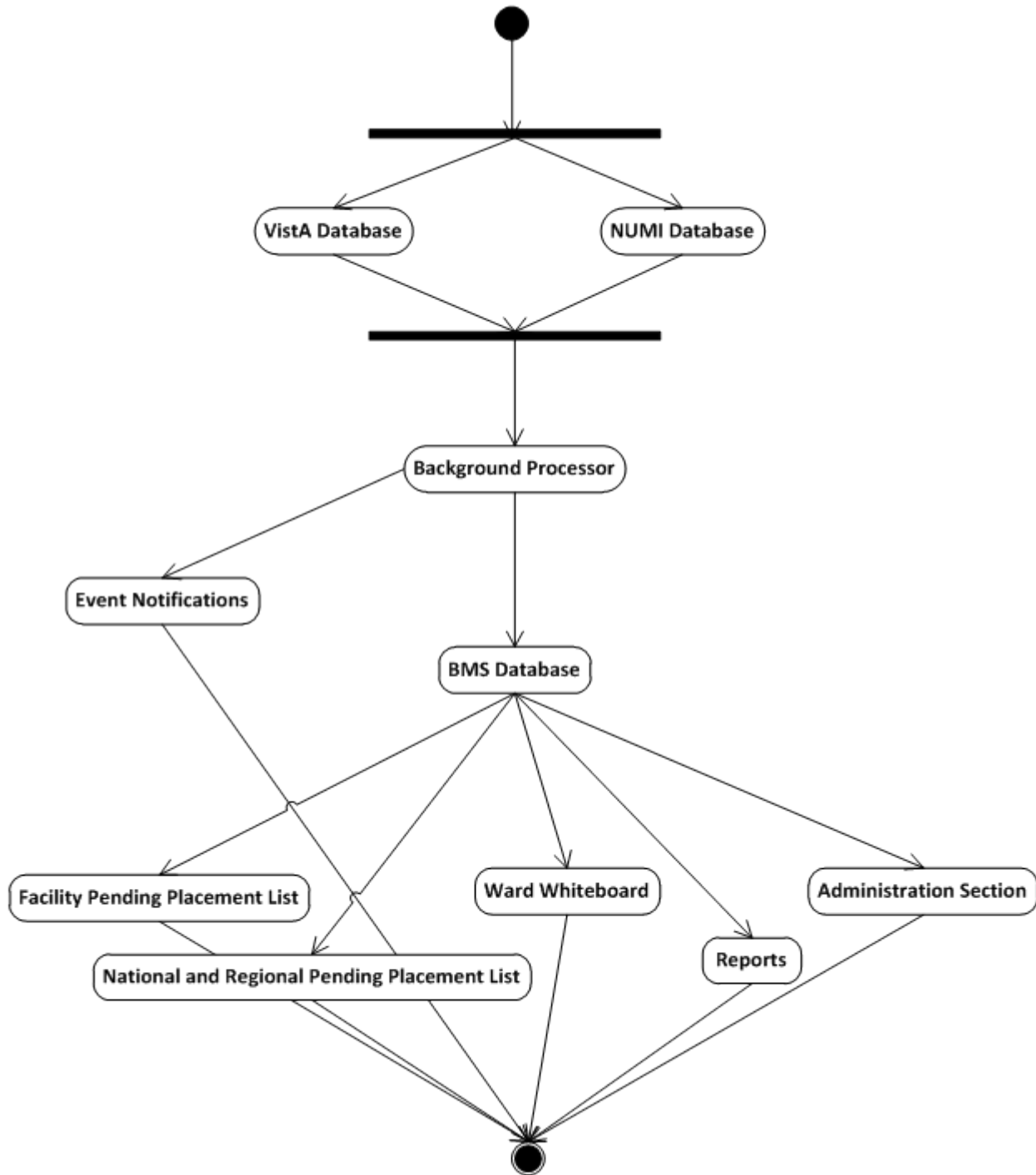

Figure 68: BMS Overview Activity Diagram

## 10.3 Functional Flow Diagram

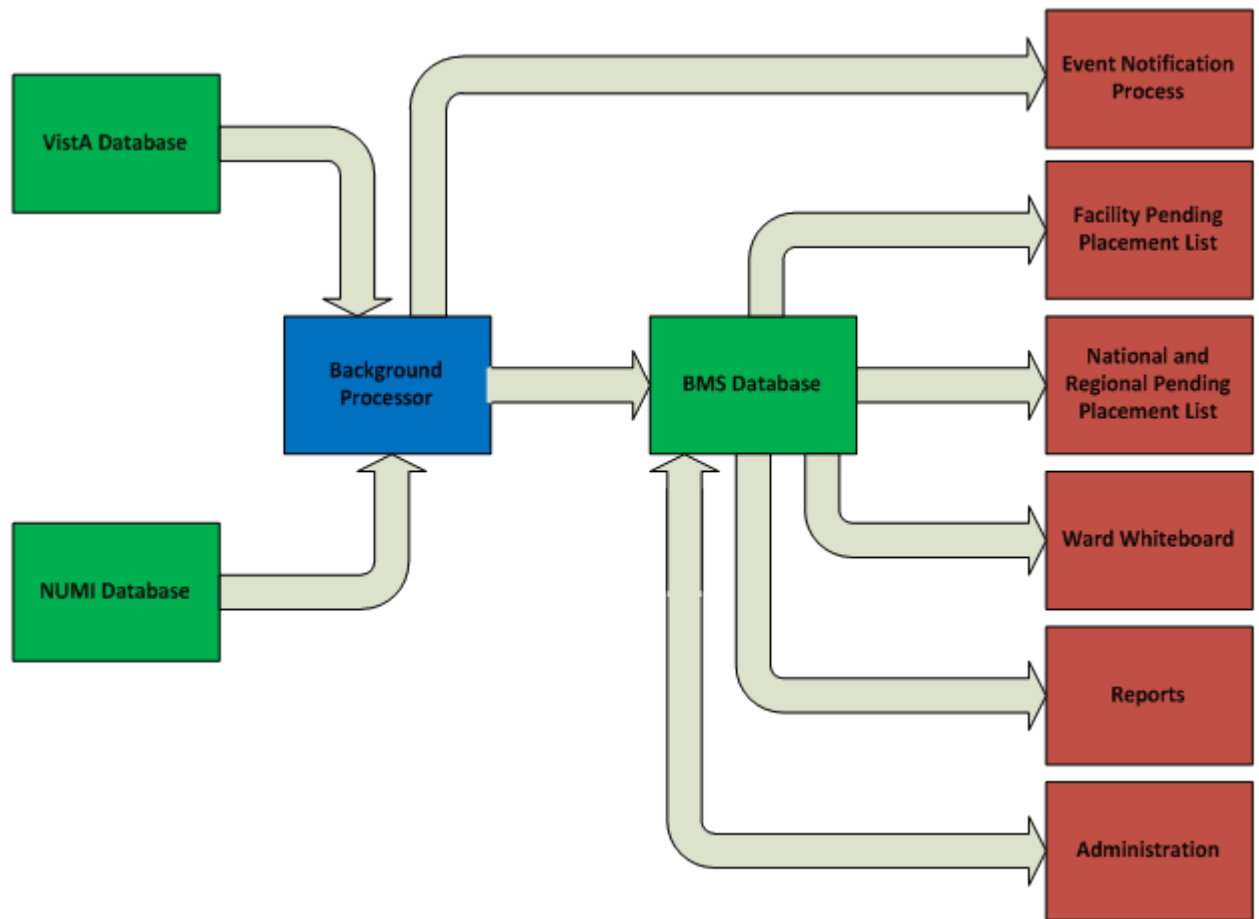

Figure 69: BMS Overview Functional Flow Diagram

## 9.4 Data Flow Diagram

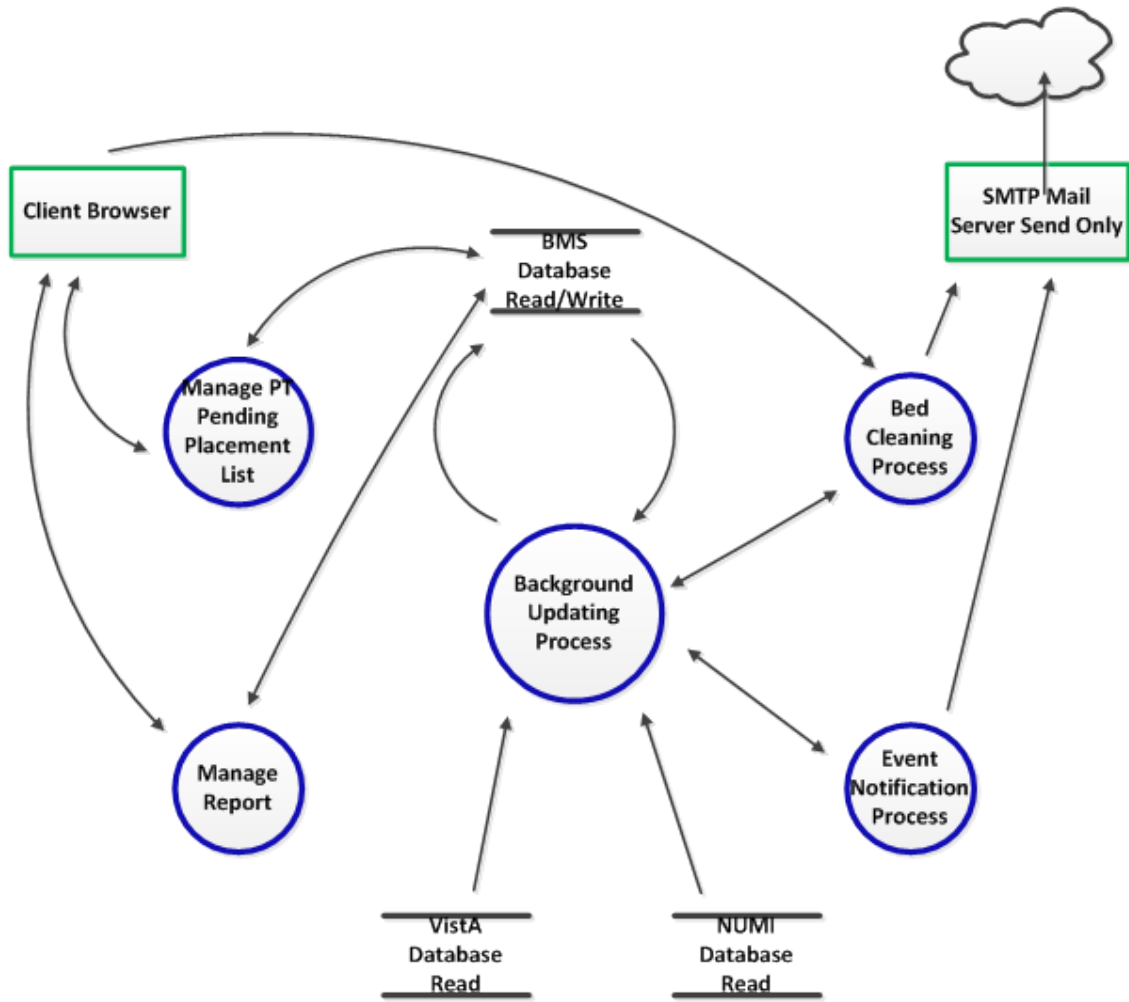
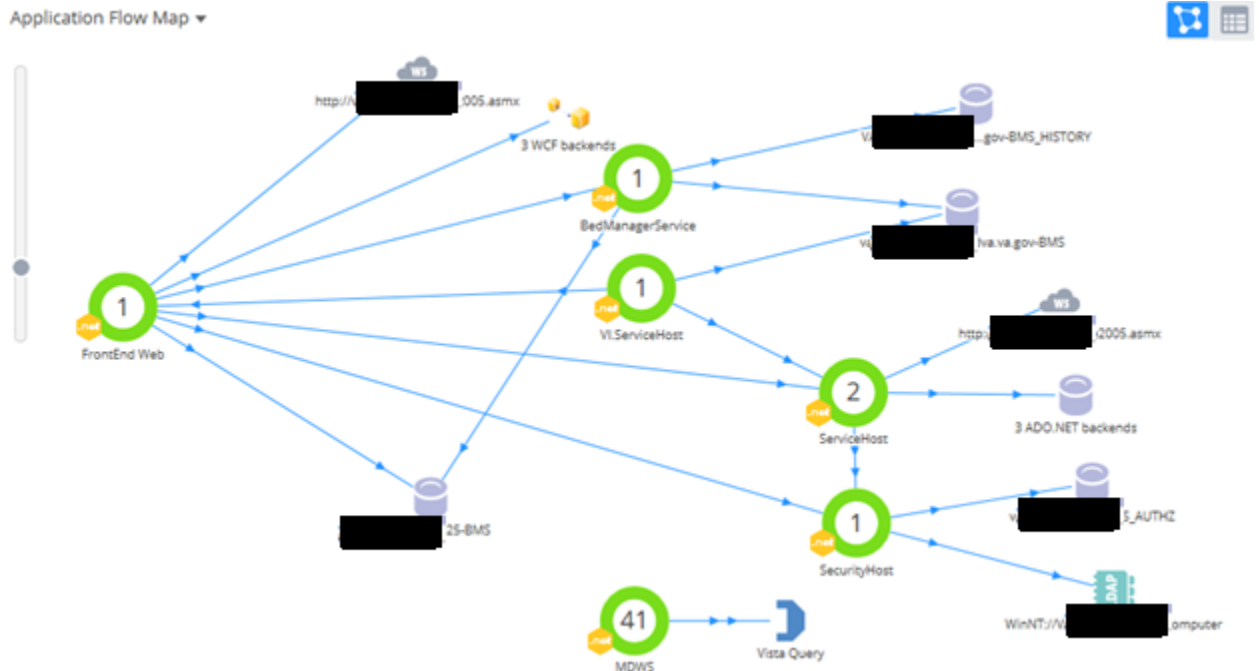

Figure 70: BMS Overview Data Flow Diagram

## 9.5 Application Flow Map from APPDYNAMICS



## 1.1 10 Appendix B - Terms, Acronyms, and Abbreviations

Table 27: Terms, Acronyms, and Abbreviations

Terms, Acronyms, Abbreviations	Definitions
ASP	Active Server Pages
BMS	Bed Management Solution
CRUD	Create, Read, Update, Delete
EIS	Entity Identification Service
EMS	Environmental Management Service
ETL	Extract Transform Load
EVS	Enterprise Vocabulary Service
IE	Internet Explorer
IIS	Internet Information Services
IRM	Information Resources Management
MDO	Medical Domain Objects
MDWS	Medical Domain Web Services
MVC	Model-View-Controller

NUMI	National Utilization Management Integration
ODBC	Open Database Connectivity
PAP	Policy Administration Point
PPBPL	Patients Pending Bed Placement List . A queue of patients in need of beds at VA facilities
PDP	Policy Decision Point
RS	Reporting Services
SOA	Service Oriented Architecture
SQL	Structured Query Language
STS	Secure Token Service
URI	Uniform Resource Identifier
URL	Uniform Resource Locator
VA	Department of Veterans Affairs
VAMC	VA Medical Center
VISN	Veterans Integrated Service Network
VistA	Veterans Health Information Systems and Technology Architecture
WCF	Windows Communication Foundation
XAML	Extensible Application Markup Language
XML	eXtensible Markup Language
WMI	Windows Management Instrumentation